

Honeywell

Voyager™ 1200g/1202g

Single-Line Laser Bar Code Scanner

User's Guide

Disclaimer

Honeywell International Inc. ("HII") reserves the right to make changes in specifications and other information contained in this document without prior notice, and the reader should in all cases consult HII to determine whether any such changes have been made. The information in this publication does not represent a commitment on the part of HII.

HII shall not be liable for technical or editorial errors or omissions contained herein; nor for incidental or consequential damages resulting from the furnishing, performance, or use of this material.

This document contains proprietary information that is protected by copyright. All rights are reserved. No part of this document may be photocopied, reproduced, or translated into another language without the prior written consent of HII.

© 2010-2011 Honeywell International Inc. All rights reserved.

Other product names or marks mentioned in this document may be trademarks or registered trademarks of other companies and are the property of their respective owners.

Web Address: www.honeywellaidc.com

Microsoft® Windows® and the Windows logo are trademarks or registered trademarks of Microsoft Corporation.

The Bluetooth® word mark and logos are owned by Bluetooth SIG, Inc.

Other product names or marks mentioned in this document may be trademarks or registered trademarks of other companies and are the property of their respective owners.

Product Agency Compliance - Voyager 1200g

USA

FCC Part 15 Subpart B Class B

This device complies with part 15 of the FCC Rules. Operation is subject to the following two conditions:

1. This device may not cause harmful interference.
2. This device must accept any interference received, including interference that may cause undesired operation.

This equipment has been tested and found to comply with the limits for a Class B digital device pursuant to part 15 of the FCC Rules. These limits are designed to provide reasonable protection against harmful interference in a residential installation. This equipment generates, uses, and can radiate radio frequency energy and, if not installed and used in accordance with the instructions, may cause harmful interference to radio communications. However, there is no guarantee that interference will not occur in a particular installation. If this equipment does cause harmful interference to radio or television reception, which can be determined by turning the equipment off and on, the user is encouraged to try to correct the interference by one or more of the following measures:

- Reorient or relocate the receiving antenna.
- Increase the separation between the equipment and receiver.
- Connect the equipment into an outlet on a circuit different from that to which the receiver is connected.
- Consult the dealer or an experienced radio or television technician for help.

If necessary, the user should consult the dealer or an experienced radio/television technician for additional suggestions. The user may find the following booklet helpful: "Something About Interference." This is available at FCC local regional offices. Honeywell is not responsible for any radio or television interference caused by unauthorized modifications of this equipment or the substitution or attachment of connecting cables and equipment other than those specified by Honeywell. The correction is the responsibility of the user.

Use only shielded data cables with this system. This unit has been tested with cables less than 3 meters. Cables greater than 3 meters may not meet class B performance.

Caution: Any changes or modifications made to this equipment not expressly approved by Honeywell may void the FCC authorization to operate this equipment.

UL Statement

UL listed: UL60950-1, 2nd Edition.

Canada

Industry Canada ICES-003

This Class B digital apparatus complies with Canadian ICES-003. Operation is subject to the following conditions:

1. This device may not cause harmful interference.
2. This device must accept any interference received, including interference that may cause undesired operation.

Conformité à la réglementation canadienne

Cet appareil numérique de la Classe B est conforme à la norme NMB-003 du Canada. Son fonctionnement est assujéti aux conditions suivantes :

1. Cet appareil ne doit pas causer de brouillage préjudiciable.
2. Cet appareil doit pouvoir accepter tout brouillage reçu, y compris le brouillage pouvant causer un fonctionnement indésirable.



C-UL Statement

C-UL listed: CSA C22.2 No.60950-1-07, Second Edition.

Europe



The CE marking indicates compliance to 2004/108/EC EMC Directive with Standards EN55022 CLASS B, EN55024, EN61000-3-2, EN61000-3-3. In addition, complies to 2006/95/EC Low Voltage Directive, when shipped with recommended power supply.

For further information please contact:

Honeywell Imaging & Mobility Europe BV
Nijverheidsweg 9-13
5627 BT Eindhoven
The Netherlands

Honeywell International Inc. shall not be liable for use of our product with equipment (i.e., power supplies, personal computers, etc.) that is not CE marked and does not comply with the Low Voltage Directive.

Waste Electrical and Electronic Equipment Information

Honeywell complies with Directive 2002/96/EC OF THE EUROPEAN PARLIAMENT AND OF THE COUNCIL of 27 January 2003 on waste electrical and electronic equipment (WEEE).

This product has required the extraction and use of natural resources for its production. It may contain hazardous substances that could impact health and the environment, if not properly disposed.

In order to avoid the dissemination of those substances in our environment and to diminish the pressure on the natural resources, we encourage you to use the appropriate take-back systems for product disposal. Those systems will reuse or recycle most of the materials of the product you are disposing in a sound way.



The crossed out wheeled bin symbol informs you that the product should not be disposed of along with municipal waste and invites you to use the appropriate separate take-back systems for product disposal.

If you need more information on the collection, reuse, and recycling systems, please contact your local or regional waste administration.

You may also contact your supplier for more information on the environmental performances of this product.

Germany



GS Statement

GS marked to EN60950-1, Second Edition.

This device is not intended for use in direct field of view at visual display workplaces. To avoid distracting reflections at visual display workplaces, this device should not be placed in direct field of view.

Australia/NZ

C-Tick Statement



Conforms to AS/NZS 3548 EMC requirement

Mexico



Conforms to NOM-019.

Russia



MJ104

Gost-R certificate

South Korea



This product meets Korean agency approval.

Taiwan

If the following label is attached to your product, the product meets Taiwan agency approval:



BSMI Standard: CNS13438, CNS 14336

依據標準：CNS13438, CNS14336

International

LED Safety Statement

LEDs have been tested and classified as “EXEMPT RISK GROUP” to the standard: IEC 62471:2006.

CB Scheme

Certified to CB Scheme IEC60950-1, Second Edition.

Laser Safety Statement

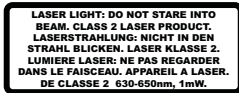

This device has been tested in accordance with and complies with IEC60825-1 ed2.0 and 21 CFR 1040.10 and 1040.11, except for deviations pursuant to Laser Notice No. 50, dated June 24, 2007.

LASER LIGHT, DO NOT STARE INTO BEAM, CLASS 2 LASER PRODUCT, 1.0 mW MAX OUTPUT: 630-650nm.

Scanner Laser Beam

Wavelength 645 - 660 nm

Divergence < 1.5 mrad. per IEC 60825-1 worst case

Max power output < 1mw

The laser diode is considered an embedded laser. Intrabeam viewing of the laser shall be prevented.

Embedded Laser

Wavelength 645- 660 nm

Divergence < 1.5 mrad, per IEC 60825-1 worst case

Max power output < 10 mw

Caution - use of controls or adjustments or performance of procedures other than those specified herein may result in hazardous radiation exposure.

Patents

For patent information, please refer to www.honeywellaidc.com/patents.

Solids and Water Protection

The Voyager 1200g has a rating of IP42, immunity of foreign particles and dripping water.

Product Agency Compliance - Voyager 1202g and CCB00-010BT

USA

FCC Part 15 Subpart C

This device complies with part 15 of the FCC Rules. Operation is subject to the following two conditions:

1. This device may not cause harmful interference.
2. This device must accept any interference received, including interference that may cause undesired operation.

Caution: Any changes or modifications made to this equipment not expressly approved by Honeywell may void the FCC authorization to operate this equipment.

Use only shielded data cables with this system. This unit has been tested with cables less than 3 meters. Cables greater than 3 meters may not meet class B performance.



UL listed: UL60950-1, Second Edition.

Canada

Industry Canada

This device complies with Canadian RSS-210. Operation is subject to the following conditions:

1. This device may not cause interference.
2. This device must accept any interference, including interference that may cause undesired operation.

Conformité à la réglementation canadienne

Cet appareil ISM est conforme à la norme CNR-210 du Canada. Son fonctionnement est assujéti aux conditions suivantes :

1. Cet appareil ne doit pas causer de brouillage préjudiciable.
2. Cet appareil doit pouvoir accepter tout brouillage reçu, y compris le brouillage pouvant causer un fonctionnement indésirable.



C-UL listed: CSA C22.2 No.60950-1-07, 2nd Edition for I.T.E. product safety.

Europe

CE The CE marking on the product indicates that this device is in conformity with all essential requirements of the 1999/5/EC R&TTE Directive. In addition, complies to 2006/95/EC Low Voltage Directive, when shipped with recommended power supply. For further information, contact:

Honeywell Imaging & Mobility Europe BV
International Inc.
Nijverheidsweg 9-13
5627 BT Eindhoven
The Netherlands

Honeywell shall not be liable for use of our product with equipment (i.e., power supplies, personal computers, etc.) that is not CE marked and does not comply with the Low Voltage Directive. This equipment is intended for use throughout the European Community and has been assessed to the following standards:

EN 300 328

EN 301 489-1

EN 301 489-17

EN60950-1

Waste Electrical and Electronic Equipment Information

Honeywell complies with Directive 2002/96/EC OF THE EUROPEAN PARLIAMENT AND OF THE COUNCIL on waste electrical and electronic equipment (WEEE).

This product has required the extraction and use of natural resources for its production. It may contain hazardous substances that could impact health and the environment, if not properly disposed.

In order to avoid the dissemination of those substances in our environment and to diminish the pressure on the natural resources, we encourage you to use the appropriate take-back systems for product disposal. Those systems will reuse or recycle most of the materials of the product you are disposing in a sound way.



The crossed out wheeled bin symbol informs you that the product should not be disposed of along with municipal waste and invites you to use the appropriate separate take-back systems for product disposal.

If you need more information on the collection, reuse, and recycling systems, contact your local or regional waste administration.

You may also contact your supplier for more information on the environmental performances of this product.

Australia/NZ

C-Tick Statement



Conforms to AS/NZS 3548 EMC requirements.

China

SRRC Radio Certificate.



CCC safety (CCB00-010BT base only)

Japan



Complies with Technical Regulations Conformity Certification of Specified Radio equipment.

Korea



This product meets Korean agency approval.

Russia



Gost-R certificate

Taiwan

If the following label is attached to your product, the product meets Taiwan agency approval:



BSMI Standard: CNS13438, CNS14336 (Voyager 1202 only)

依據標準：CNS13438, CNS14336



NCC standard: Low power frequency electric machineries technical standard: LP0002

International

LED Safety Statement

LEDs have been tested and classified as “EXEMPT RISK GROUP” to the standard: IEC 62471:2006.

Radio Technology



Class II

CB Scheme

Certified to CB Scheme IEC 60950-1, Second Edition.

Laser Safety Statement

LASER LIGHT: DO NOT STARE INTO BEAM. CLASS 2 LASER PRODUCT.
LASERSTRAHLUNG: NICHT IN DEN STRAHL BLICKEN. LASER KLASSE 2.
LUMIERE LASER: NE PAS REGARDER DANS LE FAISCEAU. APPAREIL A LASER.
DE CLASSE 2 630-650nm, 1mW.



This device has been tested in accordance with and complies with IEC60825-1 ed2.0 and 21 CFR 1040.10 and 1040.11, except for deviations pursuant to Laser Notice No. 50, dated June 24, 2007.

LASER LIGHT, DO NOT STARE INTO BEAM, CLASS 2 LASER PRODUCT, 1.0 mW MAX OUTPUT: 630-650nm.

Scanner Laser Beam

Wavelength 645 - 660 nm

Divergence < 1.5 mrad. per IEC 60825-1 worst case

Max power output < 1mw

The laser diode is considered an embedded laser. Intrabeam viewing of the laser shall be prevented.

Embedded Laser

Wavelength 645- 660 nm

Divergence < 1.5 mrad, per IEC 60825-1 worst case

Max power output < 10 mw

Caution - use of controls or adjustments or performance of procedures other than those specified herein may result in hazardous radiation exposure.

Patents

For patent information, please refer to www.honeywellaidc.com/patents.

Solids and Water Protection

The Voyager 1202g has a rating of IP42, immunity of foreign particles and dripping water.

Voyager 1200g Safety Label Locations

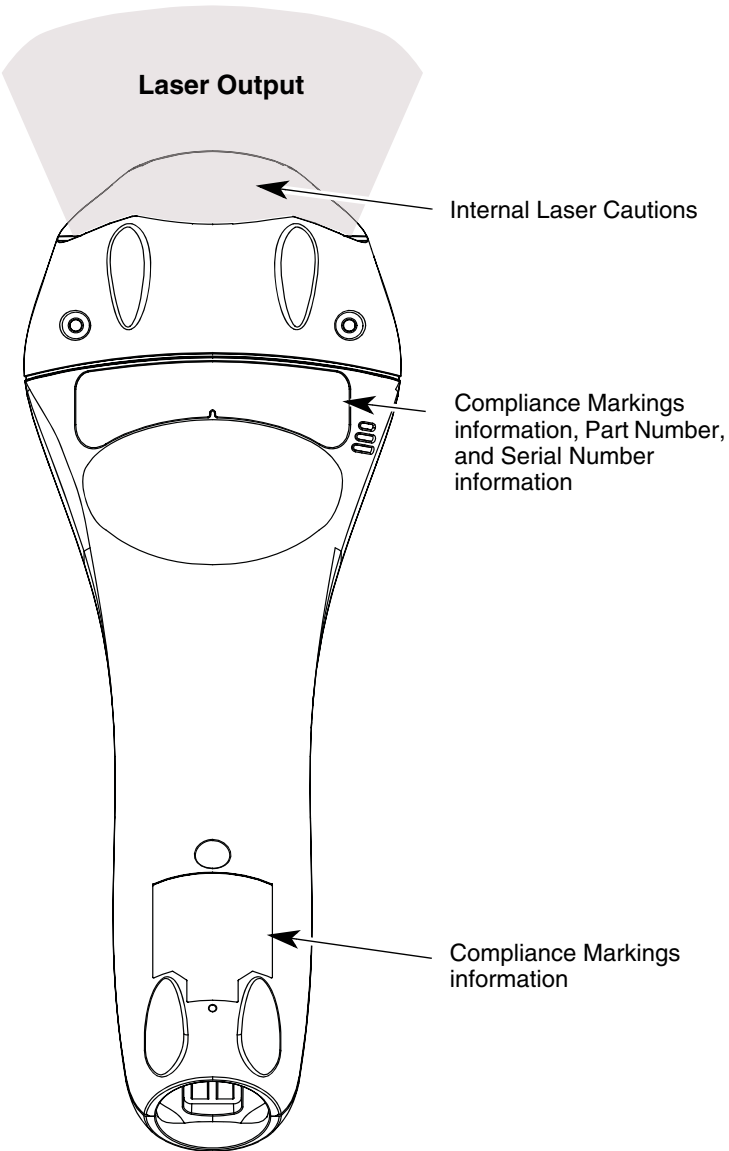

Voyager 1202g Safety Label Locations

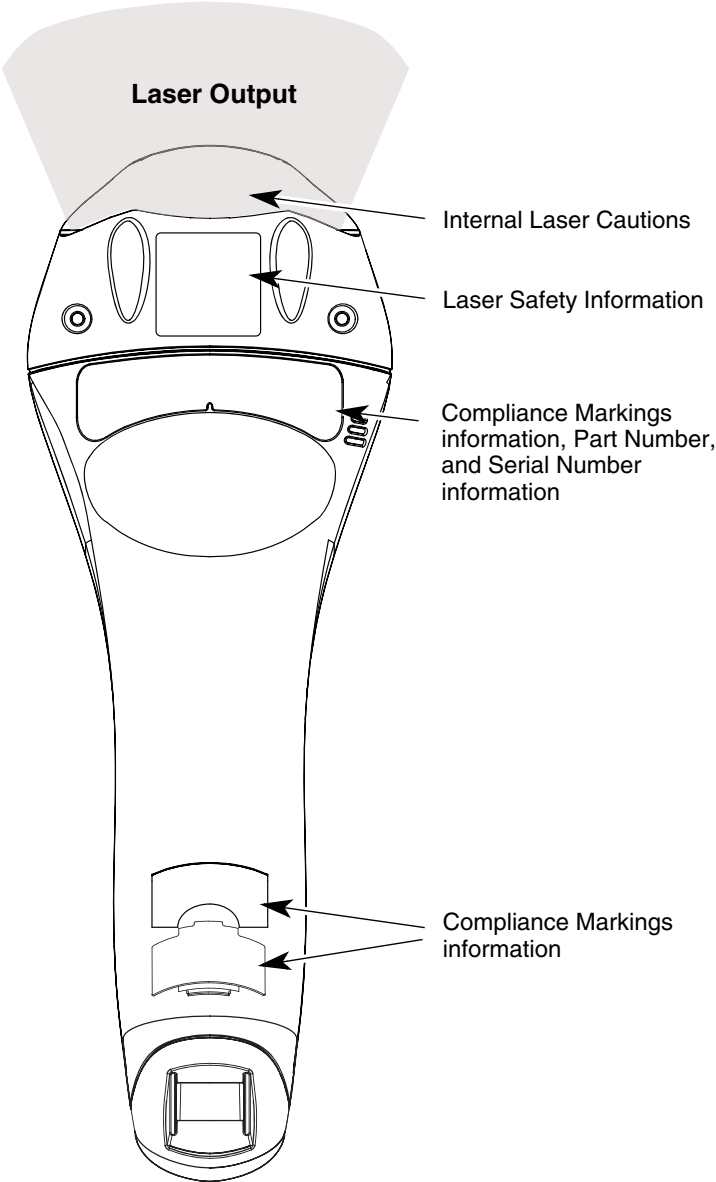

CCB00-010BT Safety Label Locations

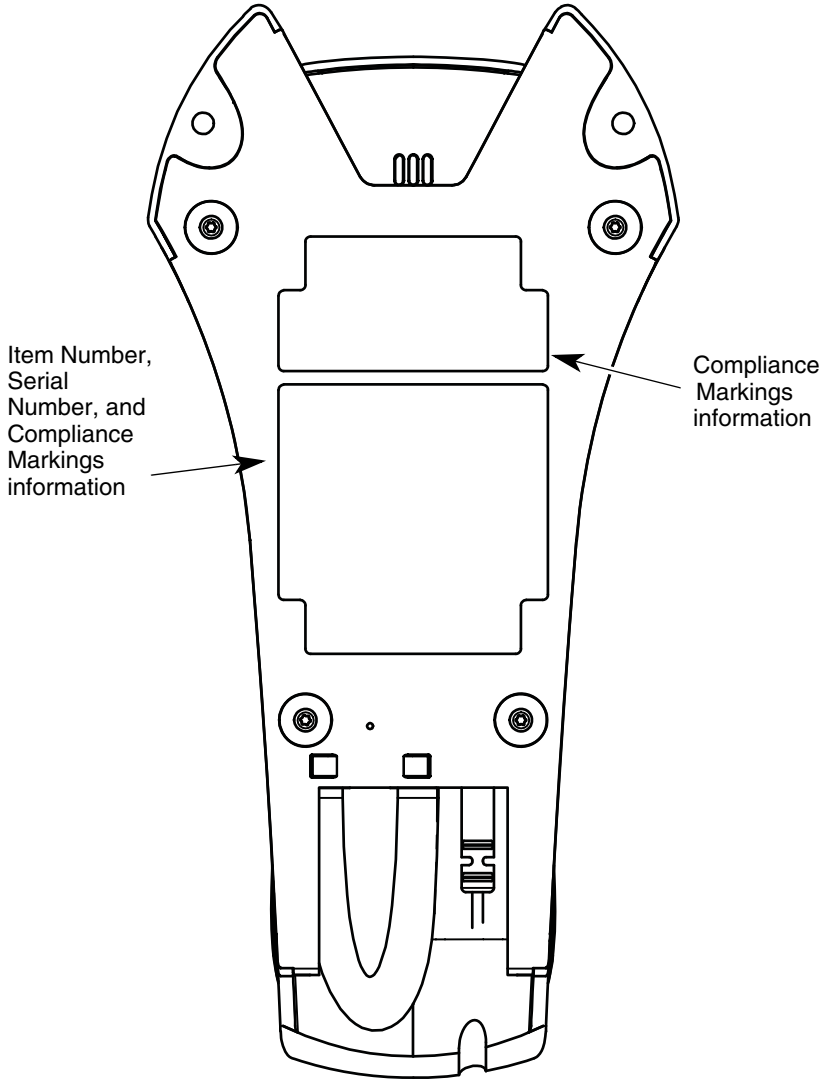



Table of Contents

Chapter 1 - Getting Started

About This Manual	1-1
Unpacking Your Device.....	1-1
Connecting the Device	1-2
Connecting with USB	1-2
Connecting with Keyboard Wedge	1-3
Connecting with RS232 Serial Port	1-5
Connecting with RS485.....	1-6
Reading Techniques	1-7
Menu Bar Code Security Settings	1-7
Setting Custom Defaults	1-8
Resetting the Custom Defaults	1-9
Resetting the Factory Defaults.....	1-9

Chapter 2 - Programming the Interface

Introduction	2-1
Programming the Interface - Plug and Play	2-1
Keyboard Wedge.....	2-1
IBM PS2 Keyboard.....	2-1
RS232 Serial Port.....	2-1
RS485	2-2
OPOS Mode	2-3
USB IBM SurePos.....	2-4
IBM Secondary Interface.....	2-4
USB PC or Macintosh Keyboard	2-5
USB HID.....	2-5
HID Fallback Mode.....	2-5
USB Serial Commands	2-6
USB Serial Emulation.....	2-6
CTS/RTS Emulation	2-6
ACK/NAK Mode.....	2-7
Communication Timeout	2-7
NAK Retries.....	2-8
Support BEL/CAN in ACK/NAK.....	2-8

Verifone® Ruby Terminal Default Settings	2-9
Gilbarco® Terminal Default Settings	2-9
Honeywell Bioptic Aux Port Configuration	2-10
Datalogic™ Magellan® Bioptic Aux Port Configuration	2-10
NCR Bioptic Aux Port Configuration	2-10
Wincor Nixdorf Terminal Default Settings	2-11
Wincor Nixdorf Beetle™ Terminal Default Settings ...	2-12
Keyboard Country Layout	2-13
Keyboard Wedge Modifiers	2-14
ALT Mode	2-14
Keyboard Style	2-15
Keyboard Conversion	2-16
Keyboard Modifiers	2-16
Inter-Scan Code Delay	2-17
<F0> Break Character	2-18
Keyboard Wedge Defaults	2-18
RS232 Modifiers	2-19
RS232 Baud Rate	2-19
RS232 Word Length: Data Bits, Stop Bits, and Parity	2-20
RS232 Handshaking	2-21
RS232 Timeout	2-22
XON/XOFF	2-23
ACK/NAK	2-23
Communication Timeout	2-23
NAK Retries	2-24
Support BEL/CAN in ACK/NAK	2-25
RS232 Defaults	2-25
NCR Modifiers	2-25
NCR ACK/NAK	2-25
Block Check Character	2-26
NCR Prefix	2-26
NCR Suffix	2-26
NCR Prefix/Suffix	2-27
NCR NOF (Not-on-File) Error	2-27
Scanner to Bioptic Communication	2-27

Scanner-Bioptic Packet Mode	2-28
ACK/NAK.....	2-28
Communication Timeout	2-28

Chapter 3 - Cordless System Operation

How the Charge and Communications Base Works ...	3-1
Linking the Scanner to a Base	3-1
Communication Between the Cordless System and the Host.....	3-2
RF (Radio Frequency) Module Operation	3-2
System Conditions	3-3
Linking Process	3-3
Scanner Is Out of Range.....	3-3
Scanner Is Moved Back Into Range.....	3-3
Out of Range and Back into Range with Batch Mode On.....	3-3
Page Button	3-3
About the Battery	3-4
Voyager 1202g Battery Removal	3-4
Charging Information.....	3-4
Battery Recommendations.....	3-5
Proper Disposal of the Battery	3-6
Flash Updates	3-6
Beeper and LED Sequences and Meaning.....	3-6
Scanner LED Sequences and Meaning	3-6
Base LED Sequences and Meaning	3-7
Base Power Communication Indicator	3-7
Reset Scanner	3-8
Scanning While in Base Cradle.....	3-8
Paging	3-8
Paging Mode	3-8
Paging Pitch	3-9
Error Indicators.....	3-9
Scanner Address.....	3-9
Base Address.....	3-10
Scanner Modes	3-10

Charge Only Mode.....	3-10
Linked Modes	3-11
Unlinking the Scanner.....	3-11
Override Locked Scanner.....	3-12
Out-of-Range Alarm.....	3-12
Alarm Sound Type	3-12
Alarm Duration.....	3-12
Scanner Power Time-Out Timer.....	3-13
Batch Mode.....	3-13
Batch Mode Beep	3-14
Batch Mode Quantity	3-14
Delete Last Code	3-17
Record Counter	3-17
Total Records	3-17
Batch Mode Output Order.....	3-18
Clear All Codes After Transmission.....	3-18
Clear All Codes.....	3-18
Transmit Records Automatically	3-19
Transmit Records to Host.....	3-19
Batch Mode Transmit Delay	3-20
Scanner Name.....	3-20
Using the Scanner with Bluetooth Devices.....	3-22
Changing the Scanner's Bluetooth PIN Code.....	3-22
Minimizing Bluetooth/ISM Band Network Activity	3-22
Auto Reconnect Mode	3-23
Maximum Link Attempts	3-24
Relink Time-Out.....	3-24
Bluetooth/ISM Network Activity Examples.....	3-24
Reset Scanner and Base.....	3-25

Chapter 4 - Input/Output Settings

Power Up Beeper	4-1
Beep on BEL Character.....	4-1
Good Read and Error Indicators.....	4-2
Beeper – Good Read.....	4-2
Beeper Volume – Good Read.....	4-2

Beeper Pitch – Good Read	4-3
Beeper - Transmit Order	4-3
Beeper Pitch – Error.....	4-3
Beeper Duration – Good Read.....	4-4
Number of Beeps – Good Read	4-4
Number of Beeps – Error	4-4
LED Indicators.....	4-6
LED Settings	4-6
LED Brightness	4-8
In-Stand and Out-Of-Stand Settings	4-8
In-Stand and Out-of-Stand Defaults	4-9
Presentation Modes	4-9
Manual Activation Mode.....	4-10
End Manual Activation After Good Read.....	4-10
Manual Activation Laser Timeout	
- Button Settings	4-11
CodeGate®	4-12
Object Detection Mode.....	4-12
End Object Detection After Good Read	4-13
Object Detection Laser Timeout.....	4-13
Object Detection Distance.....	4-14
Character Activation Mode	4-14
Activation Character.....	4-14
End Character Activation After Good Read.....	4-15
Character Activation Laser Timeout	4-15
Character Deactivation Mode.....	4-16
Deactivation Character.....	4-16
Reread Delay	4-17
User-Specified Reread Delay.....	4-17
Output Sequence Overview	4-17
Require Output Sequence.....	4-17
Output Sequence Editor.....	4-18
To Add an Output Sequence.....	4-18
Other Programming Selections	4-18
Output Sequence Editor.....	4-20
Sequence Timeout	4-20
Sequence Match Beeper.....	4-21

Partial Sequence	4-21
Require Output Sequence	4-21
No Read.....	4-22

Chapter 5 - Data Editing

Prefix/Suffix Overview.....	5-1
To Add a Prefix or Suffix:.....	5-1
To Clear One or All Prefixes or Suffixes	5-2
To Add a Carriage Return Suffix to All Symbolologies.....	5-3
Prefix Selections	5-3
Suffix Selections	5-4
Transmit Alternate Extended ASCII Characters	5-4
Function Code Transmit	5-6
Communication Check Character.....	5-6
Intercharacter, Interfunction, and Intermessage Delays.....	5-7
Intercharacter Delay	5-7
User Specified Intercharacter Delay	5-7
Interfunction Delay	5-8
Intermessage Delay	5-9

Chapter 6 - Data Formatting

Data Format Editor Introduction.....	6-1
To Add a Data Format	6-1
Other Programming Selections.....	6-3
Terminal ID Table	6-4
Data Format Editor Commands	6-4
Move Commands.....	6-5
Search Commands	6-6
Miscellaneous Commands.....	6-7
Data Formatter.....	6-8
Data Format Non-Match Error Tone	6-9
Primary/Alternate Data Formats	6-10
Single Scan Data Format Change	6-10

Chapter 7 - Symbologies

All Symbologies.....	7-1
Message Length Description.....	7-2
Codabar	7-3
Codabar Concatenation	7-4
Code 39.....	7-7
Code 32 Pharmaceutical (PARAF).....	7-9
Full ASCII	7-9
Interleaved 2 of 5	7-11
NEC 2 of 5.....	7-13
Code 93.....	7-15
Straight 2 of 5 Industrial (three-bar start/stop)	7-16
Straight 2 of 5 IATA (two-bar start/stop).....	7-18
Matrix 2 of 5	7-19
Code 11.....	7-21
Code 128.....	7-24
ISBT 128	7-25
GS1-128.....	7-31
Telepen	7-33
UPC-A	7-35
UPC-A/EAN-13 with Extended Coupon Code.....	7-38
UPC-A Number System 4 Addenda Required	7-38
UPC-A Number System 5 Addenda Required	7-39
UPC-E0	7-41
EAN/JAN-13.....	7-45
EAN-13 Beginning with 2 Addenda Required	7-46
EAN-13 Beginning with 290	
Addenda Required.....	7-47
EAN-13 Beginning with 378/379	
Addenda Required.....	7-47
EAN-13 Beginning with 414/419	
Addenda Required.....	7-48
EAN-13 Beginning with 434/439	
Addenda Required.....	7-49
EAN-13 Beginning with 977	
Addenda Required.....	7-50

EAN-13 Beginning with 978	
Addenda Required	7-50
EAN-13 Beginning with 979	
Addenda Required	7-51
ISBN Translate	7-53
ISSN Translate	7-54
EAN/JAN-8	7-55
MSI	7-58
Plessey Code.....	7-60
GS1 DataBar Omnidirectional	7-62
GS1 DataBar Limited.....	7-63
GS1 DataBar Expanded	7-64
Trioptic Code	7-65
GS1 Emulation.....	7-65
Postal Codes	7-66
China Post (Hong Kong 2 of 5).....	7-66

Chapter 8 - Interface Keys

Keyboard Function Relationships	8-1
Supported Interface Keys	8-2

Chapter 9 - Utilities

To Add a Test Code I.D. Prefix to All Symbologies	9-1
Show Software Revision.....	9-1
Show Data Format.....	9-1
Test Menu.....	9-2
EZConfig-Scanning Introduction.....	9-2
Installing EZConfig-Scanning from the Web.....	9-3

Chapter 10 - Serial Programming Commands

Conventions.....	10-1
Menu Command Syntax	10-1
Query Commands.....	10-2
Responses.....	10-3
Serial Trigger Commands.....	10-4

Read Time-Out.....	10-4
Resetting the Standard Product Defaults.....	10-4
Menu Commands.....	10-6

Chapter 11 - Product Specifications

Voyager 1200g Product Specifications	11-1
Voyager 1202g Product Specifications	11-3
CCB00-010BT Product Specifications	11-4
CCB00-010BT Mounting	11-6
Standard Cable Pinouts	11-7
Keyboard Wedge.....	11-7
Serial Output	11-8
RS485 Output	11-9
USB.....	11-10

Chapter 12 - Maintenance

Repairs.....	12-1
Maintenance.....	12-1
Cleaning the Device	12-1
Inspecting Cords and Connectors	12-1
Replacing Cables in Corded Scanners	12-1
Replacing an Interface Cable in a Corded Scanner.....	12-2
Replacing Cables in Cordless Systems	12-2
Replacing an Interface Cable in a Base	12-2
Troubleshooting a Voyager Scanner.....	12-3
Troubleshooting a Cordless System	12-4
Troubleshooting a Base	12-4
Troubleshooting a Cordless Scanner	12-5

Chapter 13 - Customer Support

Technical Assistance	13-1
----------------------------	------

Appendix A - Reference Charts

Symbology Chart.....	A-1
----------------------	-----

ASCII Conversion Chart (Code Page 1252)	A-4
Code Page Mapping of Printed Barcodes	A-6

Getting Started

About This Manual

This User's Guide provides installation and programming instructions for the Voyager 1200g/1202g linear scanner. Product specifications, dimensions, warranty, and customer support information are also included.

Honeywell bar code scanners are factory programmed for the most common terminal and communications settings. If you need to change these settings, programming is accomplished by scanning the bar codes in this guide.

An asterisk (*) next to an option indicates the default setting.

Unpacking Your Device

After you open the shipping carton containing the product, take the following steps:

- Check for damage during shipment. Report damage immediately to the carrier who delivered the carton.
- Make sure the items in the carton match your order.
- Save the shipping container for later storage or shipping.

Connecting the Device

Connecting with USB

A scanner or a base can be connected to the USB port of a computer.

1. Connect the appropriate interface cable to the scanner first, then to the computer.

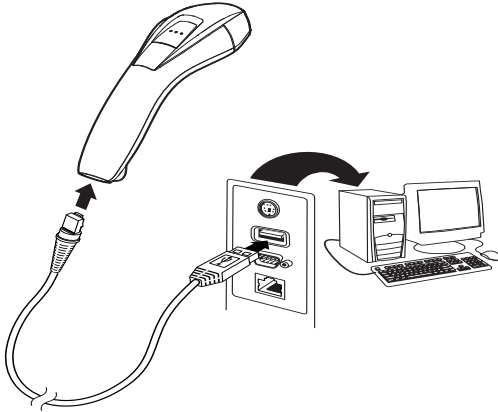

Charge and Communications Base USB Connection:

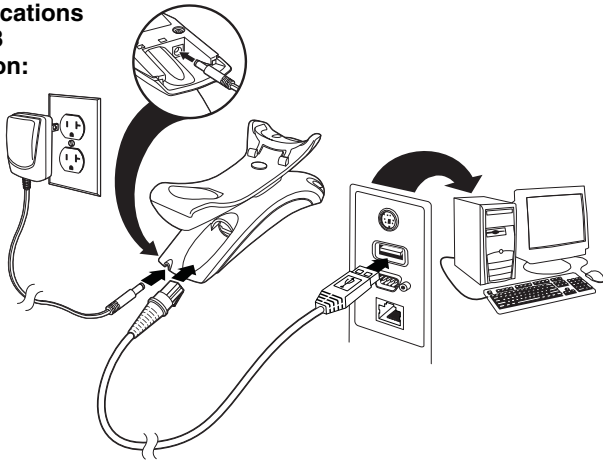

2. Make sure the cables are secured in the wireways in the bottom of the base and that the base sits flat on a horizontal surface.
3. The scanner beeps.

4. Verify the scanner or base operation by scanning a bar code from the [Sample Symbols](#) in the back of this manual.

The unit defaults to a USB PC Keyboard. Refer to [page 2-5](#) for other USB terminal settings.

For additional USB programming and technical information, refer to “USB Application Note,” available at www.honeywellaidc.com.

Connecting with Keyboard Wedge

A scanner or base can be connected between the keyboard and PC as a “keyboard wedge,” where the scanner provides data output that is similar to keyboard entries. The following is an example of a keyboard wedge connection:

1. Turn off power and disconnect the keyboard cable from the back of the terminal/computer.

Connect the appropriate interface cable to the scanner and to the terminal/computer.

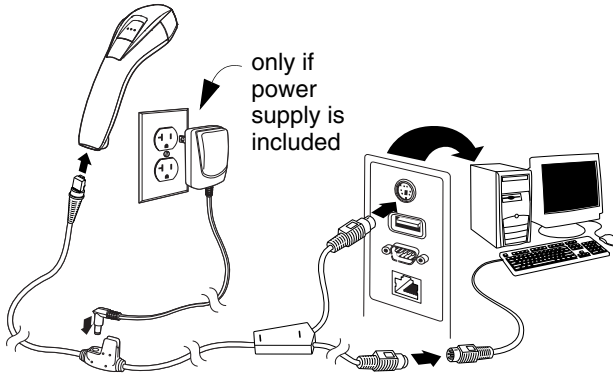

**Charge and
Communications Base
Keyboard Wedge
Connection:**

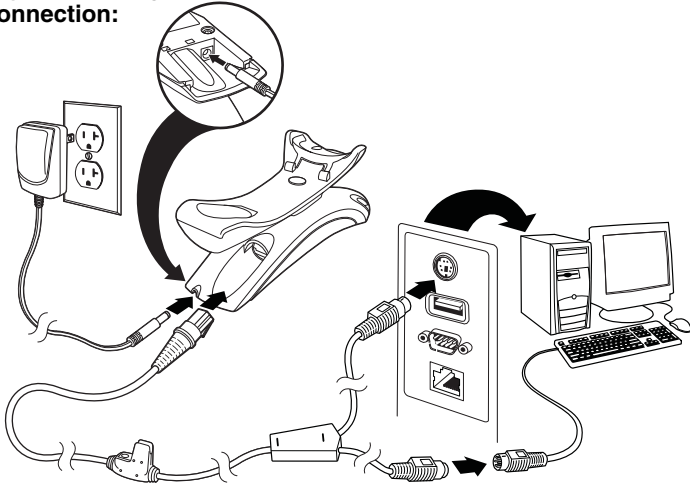

2. Make sure the cables are secured in the wireways in the bottom of the base and that the base sits flat on a horizontal surface.
3. Turn the terminal/computer power back on. The scanner beeps.
4. Verify the scanner or base operation by scanning a bar code from the [Sample Symbols](#) in the back of this manual. The scanner beeps once.

The unit defaults to an IBM PC AT and compatibles keyboard wedge interface with a USA keyboard. A carriage return (CR) suffix is added to bar code data.

Connecting with RS232 Serial Port

1. Turn off power to the terminal/computer.
2. Connect the appropriate interface cable to the scanner.

Note: For the scanner or base to work properly, you must have the correct cable for your type of terminal/computer.

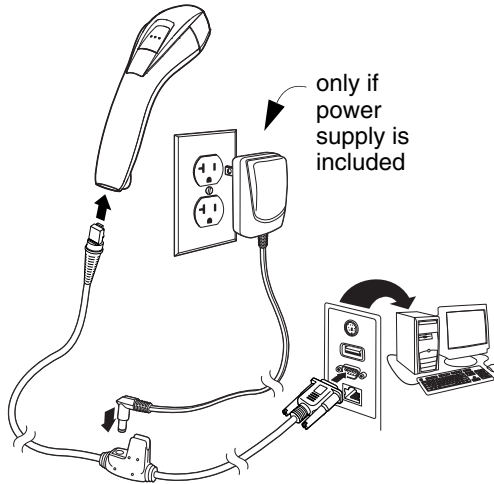

Charge and Communications Base RS232 Serial Port Connection:

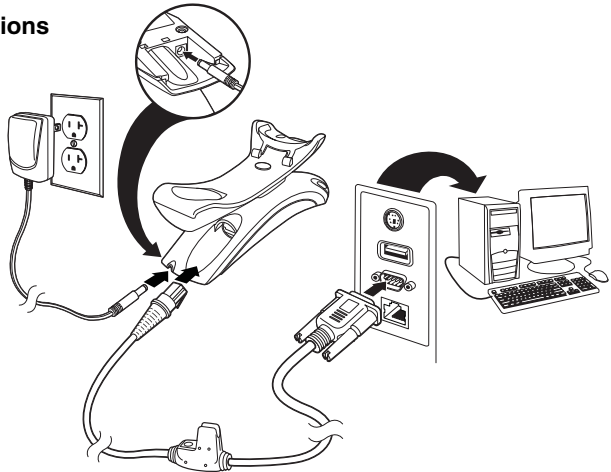

3. Make sure the cables are secured in the wireways in the bottom of the base and that the base sits flat on a horizontal surface.
4. Plug the serial connector into the serial port on your computer. Tighten the two screws to secure the connector to the port.
5. Once the scanner or base has been fully connected, power up the computer.

This interface programs 9600 baud, 8 data bits, no parity, and 1 stop bit.

Connecting with RS485

A scanner or base can be connected for an IBM POS terminal interface.

1. Connect the appropriate interface cable to the device, then to the computer.

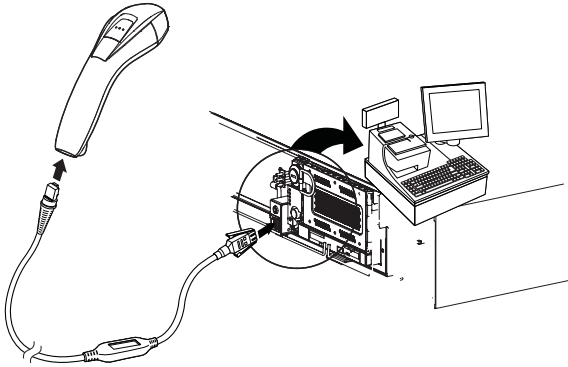

Charge and Communications Base RS485 Connection:

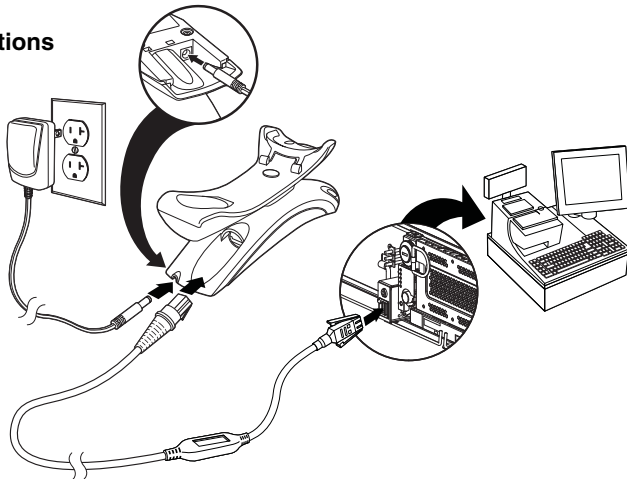

-
2. Make sure the cables are secured in the wireways in the bottom of the base and that the base sits flat on a horizontal surface.
 3. Turn the terminal/computer power back on. The scanner beeps.
 4. Verify the scanner or base operation by scanning a bar code from the [Sample Symbols](#) in the back of this manual. The scanner beeps once.

For further RS485 settings, refer to [RS485](#), page 2-2.

Reading Techniques

The scanner has a view finder that projects a bright red aiming beam that corresponds to the scanner's horizontal field of view. The aiming beam should be centered horizontally over the bar code and must highlight all the vertical bars of the bar code. It will not read if the aiming beam is in any other direction.

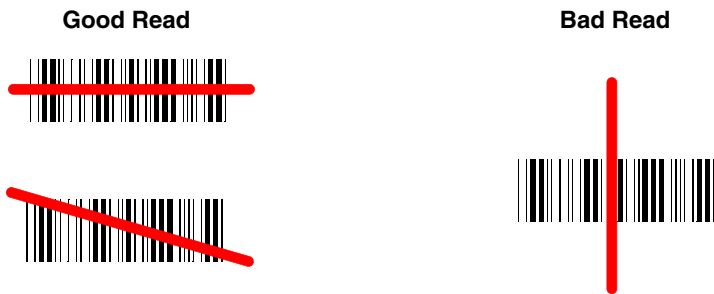

The aiming beam is smaller when the scanner is closer to the code and larger when it is farther from the code. Symbologies with smaller bars or elements (mil size) should be read closer to the unit. Symbologies with larger bars or elements (mil size) should be read farther from the unit. To read single or multiple symbols (on a page or on an object), hold the scanner at an appropriate distance from the target, press the button, and center the aiming beam on the symbol. If the code being scanned is highly reflective (e.g., laminated), it may be necessary to tilt the code up 15° to 18° to prevent unwanted reflection.

Menu Bar Code Security Settings

Honeywell scanners are programmed by scanning menu bar codes or by sending serial commands to the scanner. If you want to restrict the ability to scan menu codes, you can use the Menu Bar Code Security settings. Please contact the nearest technical support office (see [Limited Warranty](#) on page 13-2) for further information.

Setting Custom Defaults

You have the ability to create a set of menu commands as your own, custom defaults. To do so, scan the **Set Custom Defaults** bar code below before each menu command or sequence you want saved. If your command requires scanning numeric codes from the back cover, then a **Save** code, that entire sequence will be saved to your custom defaults. Scan the **Set Custom Defaults** code again before the next command you want saved to your custom defaults.

When you have entered all the commands you want to save for your custom defaults, scan the **Save Custom Defaults** bar code.



MNUCDF.

Set Custom Defaults



DEFAULT.

Save Custom Defaults

*Note: If using a cordless system, scanning the **Save Defaults** bar code also causes both the scanner and the base to perform a reset and become unlinked. The scanner must be placed in its base to re-establish the link before any setup codes are entered. See [Cordless System Operation](#) beginning on page 3-1 for additional information.*

You may have a series of custom settings and want to correct a single setting. To do so, just scan the new setting to overwrite the old one. For example, if you had previously saved the setting for Beeper Volume at Low to your custom defaults, and decide you want the beeper volume set to High, just scan the **Set Custom Defaults** bar code, then scan the Beeper Volume High menu code, and then **Save Custom Defaults**. The rest of the custom defaults will remain, but the beeper volume setting will be updated.

Resetting the Custom Defaults

If you want the custom default settings restored to your scanner, scan the **Activate Custom Defaults** bar code below. This resets the scanner to the custom default settings. If there are no custom defaults, it will reset the scanner to the factory default settings. Any settings that have not been specified through the custom defaults will be defaulted to the factory default settings.



DEFAULT.

Activate Custom Defaults

Note: If using a cordless system, scanning this bar code also causes both the scanner and the base to perform a reset and become unlinked. The scanner must be placed in its base to re-establish the link before any setup codes are entered. See [Cordless System Operation](#) beginning on page 3-1 for additional information.

Resetting the Factory Defaults



This selection erases all your settings and resets the scanner to the original factory defaults.

If you aren't sure what programming options are in your scanner, or you've changed some options and want to restore the scanner to factory default settings, first scan the **Remove Custom Defaults** bar code, then scan **Activate Defaults**. This resets the scanner to the factory default settings.



DEFOVR.

Remove Custom Defaults



DEFAULT.

Activate Defaults

*Note: If using a cordless system, scanning the **Activate Defaults** bar code also causes both the scanner and the base to perform a reset and become unlinked. The scanner must be placed in its base to re-establish the link before any setup codes are entered. See [Cordless System Operation](#) beginning on page 3-1 for additional information.*

The [Serial Programming Commands](#), beginning on page 10-1 list the factory default settings for each of the commands (indicated by an asterisk (*) on the programming pages).



Introduction

This chapter describes how to program your system for the desired interface.

Programming the Interface - Plug and Play

Plug and Play bar codes provide instant scanner set up for commonly used interfaces.

Note: After you scan one of the codes, power cycle the host terminal to have the interface in effect.

Keyboard Wedge

If you want your system programmed for an IBM PC AT and compatibles keyboard wedge interface with a USA keyboard, scan the bar code below. Keyboard wedge is the default interface.

Note: The following bar code also programs a carriage return (CR) suffix.



PAP_AT.

IBM PC AT and Compatibles with CR Suffix

IBM PS2 Keyboard

The following bar code programs you scanner for an IBM PS2 keyboard wedge interface with a USA keyboard.

Note: The following bar code also programs a carriage return (CR) suffix.



PAPPS2.

IBM PS2 with CR Suffix

RS232 Serial Port

The **RS232 Interface** bar code is used when connecting to the serial port of a PC or terminal. The following **RS232 Interface** bar code also programs a carriage return (CR) and a line feed (LF) suffix, baud rate, and data format as indicated below.

Option	Setting
Baud Rate	115,200 bps
Data Format	8 data bits, no parity bit, 1 stop bit



PAPER232.

RS232 Interface

RS485

Scan one of the following “Plug and Play” codes to program the scanner for an IBM POS terminal interface.

Note: After scanning one of these codes, you must power cycle the cash register.



PAPP5B.

IBM Port 5B Interface



PAPER9B1.

**IBM Port 9B
HHBCR-1 Interface**



PAPP17.

IBM Port 17 Interface



PAPER9B2.

**IBM Port 9B
HHBCR-2 Interface**

Each bar code above also programs the following suffixes for each symbology:

Symbology	Suffix	Symbology	Suffix
EAN 8	0C	Code 39	00 0A 0B
EAN 13	16	Interleaved 2 of 5	00 0D 0B
UPC A	0D	Code 128 *	00 0A 0B
UPC E	0A	Code 128 **	00 18 0B

* Suffixes programmed for Code 128 with IBM 4683 Port 5B, IBM 4683 Port 9B HHBCR-1, and IBM 4683 Port 17 Interfaces

**Suffixes programmed for Code 128 with IBM 4683 Port 9 HHBCR-2 Interface

OPOS Mode

The following bar code configures your scanner for OPOS (OLE for Retail Point of Sale) by modifying the following OPOS-related settings:

Option	Setting
Interface	RS232
Baud Rate	38400
RS232 Handshaking	Flow Control, No Timeout
	XON/XOFF Off
	ACK/NAK Off
Data Bits, Stop Bits, and Parity	8 Data, 1 Stop, Parity None
Prefix/Suffix	Clear All Prefixes and Suffixes
	Add Code ID and AIM ID Prefix
	Add CR Suffix
Intercharacter Delay	Off
Symbologies	Enable UPC-A with check digit and number system
	Enable UPC-E0 with check digit
	Enable EAN/JAN-8 with check digit
	Enable EAN/JAN-13 with check digit
	Enable Code 128
	Enable Code 39
	Enable OPOS with automatic disable off



PAPOPS.
OPOS Mode

USB IBM SurePos

Scan one of the following “Plug and Play” codes to program the scanner for an IBM SurePos (USB handheld scanner) or IBM SurePos (USB tabletop scanner) interface.

Note: After scanning one of these codes, you must power cycle the cash register.



PAPSPH.

**USB IBM SurePos
(USB Handheld Scanner)
Interface**



PAPSP.T.

**USB IBM SurePos
(USB Tabletop Scanner)
Interface**

Each bar code above also programs the following suffixes for each symbology:

Symbology	Suffix	Symbology	Suffix
EAN 8	0C	Code 39	00 0A 0B
EAN 13	16	Interleaved 2 of 5	00 0D 0B
UPC A	0D	Code 128	00 18 0B
UPC E	0A	Code 39	00 0A 0B

IBM Secondary Interface

On some older IBM cash registers, it may be necessary to disable the secondary or management interface. In particular, it has been found necessary on IBM registers using the 4690 V2R4 operating system. The following bar codes are used for this purpose. *Default = Enable Secondary Interface.*



REMIFC1.

***Enable Secondary Interface**



REMIFC0.

Disable Secondary Interface

USB PC or Macintosh Keyboard

Scan one of the following codes to program the scanner for USB PC Keyboard or USB Macintosh Keyboard. Scanning these codes also adds a CR and LF.



PAPER124.

USB Keyboard (PC)



PAPER125.

USB Keyboard (Mac)



PAPER134.

USB Japanese Keyboard (PC)

USB HID

Scan the following code to program the scanner for USB HID bar code scanners.



PAPER131.

USB HID Bar Code Scanner

HID Fallback Mode

If you attempt to set a USB interface for your scanner, but the setup fails on the host system, you can program the scanner to fall back to a HID keyboard interface after a set length of time. For example, if the scanner is configured for Serial Emulation Mode, but the host system does not have the correct driver, the scanner would fail. If you set the **HID Fallback Mode** for a set length of time, for example, 5 minutes, the scanner would change to a HID keyboard interface after 5 minutes of trying to configure as serial emulation.

A unique beep sequence indicates that this mode has been entered. While in HID Fallback Mode, the scanner will not scan normal bar codes and sounds a unique beep sequence that indicates the scanner is in Fallback Mode. Menu codes can still be scanned while in HID Fallback Mode, allowing you to change the scanner's programming.

Scan the bar code below, then set the length for the HID Fallback (from 0-60 minutes) by scanning digits from the [Programming Chart](#), then scanning **Save**. *Default = 5 minutes.*



USBFT0.

HID Fallback Mode

USB Serial Commands

USB Serial Emulation

Scan one of the following codes to program the scanner to emulate a regular RS232-based COM Port. If you are using a Microsoft® Windows® PC, you will need to download a driver from the Honeywell website (www.honeywellaidc.com). The driver will use the next available COM Port number. Apple® Macintosh computers recognize the scanner as a USB CDC class device and automatically uses a class driver.

Scanning either of these codes also adds a CR and LF.



PAP130.

**USB Serial Emulation for
Windows XP, Windows Server
2003, and later**



REMIFC0;PAP130.

USB Serial Emulation for Windows 2000

Note: No extra configuration (e.g., baud rate) is necessary.

CTS/RTS Emulation



USBCTS1.

CTS/RTS Emulation On



USBCTS0.

*** CTS/RTS Emulation Off**

ACK/NAK Mode



USBACK1.

ACK/NAK Mode On



USBACK0.

*** ACK/NAK Mode Off**

Communication Timeout

This allows you to set the length (in milliseconds) for a timeout for the host ACK/NAK response. Scan the bar code below, then set the timeout (from 0-65535 milliseconds) by scanning digits from the [Programming Chart](#), then scanning **Save**. *Default = 2000 ms.*



232DLK.

Communication Timeout

Timeout Retries

This setting limits the number of Communication Timeout retries. If the Timeout Retries is set to 0, the transmission is terminated after the initial Communication Timeout. Scan the bar code below, then set the number of retries (from 0-255) by scanning digits from the [Programming Chart](#), then scanning **Save**. (5 is the recommended setting.) *Default = 0.*



HSTRTY.

Timeout Retries

Communication Timeout Beeper

This selection programs the scanner to issue an error beep when a communication timeout has occurred. The error beep sound is programmed using [Number of Beeps – Error](#) (page 4-4). *Default = On.*



NAK Retries

This selection limits the number of NAK retries that can occur in ACK/NAK mode. Scan the bar code below, then set the number of retries (from 0-255) by scanning digits from the [Programming Chart](#), then scanning [Save](#). (5 is the recommended setting.) *Default = 0, or disabled.*



Support BEL/CAN in ACK/NAK

This protocol responds to <BEL> and <CAN> commands when in ACK/NAK mode. The scanner sounds an error tone when a <BEL> command is sent from the host. <CAN> terminates the transmission. *Default = BEL/CAN Off.*



Verifone[®] Ruby Terminal Default Settings

Scan the following Plug and Play code to program the scanner for a Verifone Ruby terminal. This bar code sets the baud rate to 1200 bps and the data format to 8 data bits, Mark parity, 1 stop bit and RTS/CTS no timeout. It also adds a line feed (LF) suffix and programs the following prefixes for each symbology:

Symbology	Prefix
UPC-A	A
UPC-E	A
EAN-8	FF
EAN-13	F



PAPRBY.

Verifone Ruby Settings

Note: If you are having unexpected results with this programming code, scan the [Activate Defaults](#) bar code on page 1-9 first, then scan the programming code above.

Gilbarco[®] Terminal Default Settings

Scan the following Plug and Play code to program the scanner for a Gilbarco terminal. This bar code sets the baud rate to 2400 bps and the data format to 7 data bits, even parity, 2 stop bits. It also adds a carriage return (CR) suffix and programs the following prefixes for each symbology:

Symbology	Prefix
UPC-A	A
UPC-E	E0
EAN-8	FF
EAN-13	F



PAPGLB.

Gilbarco Settings

Note: If you are having unexpected results with this programming code, scan the [Activate Defaults](#) bar code on page 1-9 first, then scan the programming code above.

Honeywell Bioptic Aux Port Configuration

Scan the following Plug and Play code to program the scanner for a Honeywell bioptic scanner auxiliary port configuration. This bar code sets the baud rate to 38400 bps and the data format to 8 data bits, no parity, 1 stop bit. Character RTS/CTS with timeout and 232 ACK/NAK are also enabled.



PAPBIO.

Honeywell Bioptic Settings

Note: If you are having unexpected results with this programming code, scan the [Activate Defaults](#) bar code on page 1-9 first, then scan the programming code above.

Datalogic™ Magellan® Bioptic Aux Port Configuration

Scan the following Plug and Play code to program the scanner for a Datalogic Magellan bioptic scanner auxiliary port configuration. This bar code sets the baud rate to 9600 bps and the data format to 8 data bits, no parity, 1 stop bit.



PAPMAG.

Datalogic Magellan Bioptic Settings

Note: If you are having unexpected results with this programming code, scan the [Activate Defaults](#) bar code on page 1-9 first, then scan the programming code above.

NCR Bioptic Aux Port Configuration

Scan the following Plug and Play code to program the scanner for an NCR biopic scanner auxiliary port configuration. This bar code sets the baud rate to 9600 bps and the data format to 7 data bits, Even parity, 1 stop bit and Message RTS/CTS with timeout. The following prefixes are programmed for each symbology:

Symbology	Prefix	Symbology	Prefix
UPC-A	A	Code 39	B1
UPC-E	E0	Interleaved 2 of 5	B2
EAN-8	FF	All other bar codes	B3
EAN-13	F		



PAPNCR.
NCR Bioptic Settings

Note: If you are having unexpected results with this programming code, scan the [Activate Defaults](#) bar code on page 1-9 first, then scan the programming code above.

Wincor Nixdorf Terminal Default Settings

Scan the following Plug and Play code to program the scanner for a Wincor Nixdorf terminal. This bar code sets the baud rate to 9600 bps and the data format to 8 data bits, no parity, 1 stop bit.



PAPWNX.
Wincor Nixdorf Terminal Settings

Note: If you are having unexpected results with this programming code, scan the [Activate Defaults](#) bar code on page 1-9 first, then scan the programming code above.

Wincor Nixdorf Beetle™

Terminal Default Settings

Scan the following Plug and Play code to program the scanner for a Wincor Nixdorf Beetle terminal. The following prefixes are programmed for each symbology:

Symbology	Prefix	Symbology	Prefix
Code 128	K	EAN-13	A
Code 93	L	GS1-128	P
Codabar	N	Interleaved 2 of 5	I
UPC-A	A0	Plessey	O
UPC-E	C	Straight 2 of 5 IATA	H
EAN-8	B	All other bar codes	M



PAPBTL

Wincor Nixdorf Beetle Settings

Note: If you are having unexpected results with this programming code, scan the [Activate Defaults](#) bar code on page 1-9 first, then scan the programming code above.

Keyboard Country Layout

Scan the appropriate country code below to program the keyboard layout for your country or language. As a general rule, the following characters are supported, but need special care for countries other than the United States:

@ | \$ # { } [] = / ' \ < > ~



KBDCTY0.

* **United States**



KBDCTY1.

Belgium



KBDCTY2.

Finland



KBDCTY4.

Germany



KBDCTY90.

IBM Financial



KBDCTY28.

Japan ASCII



KBDCTY91.

Arabic



KBDCTY92.

Chinese



KBDCTY3.

France



KBDCTY19.

Hungary



KBDCTY5.

Italy



KBDCTY93.

Korea

Keyboard Country (continued)



KBDCTY26.
Russia



KBDCTY10.
Spain



KBDCTY94.
Thailand



KBDCTY7.
United Kingdom



KBDCTY31.
Slovenia



KBDCTY6.
Switzerland (German)



KBDCTY24.
Turkey Q



KBDCTY95.
Vietnam

Keyboard Wedge Modifiers

ALT Mode

If your bar code contains special characters from the extended ASCII chart for example, an e with an accent grave (è), you will use ALT Mode. (See [Extended ASCII Characters](#) on page A-5.)

Note: Scan the ALT mode bar code after scanning the appropriate Keyboard Country code.

If your keystrokes require using the ALT key and 3 characters, scan the **3 Characters** bar code. If your keystrokes require the ALT key and 4 characters, scan the **4 Characters** bar code. The data is then output with the special character(s). *Default = Off.*



KBDALT0.

* Off



KBDALT6.

3 Characters



KBDALT7.

4 Characters

Keyboard Style

This programs keyboard styles, such as Caps Lock and Shift Lock. If you have used [Keyboard Conversion](#) settings, they will override any of the following Keyboard Style settings. *Default = Regular.*

Regular is used when you normally have the Caps Lock key off.



KBDSTY0.

* Regular

Caps Lock is used when you normally have the Caps Lock key on.



KBDSTY1.

Caps Lock

Shift Lock is used when you normally have the Shift Lock key on (not common to U.S. keyboards).



KBDSTY2.

Shift Lock

Autocaps via NumLock bar code should be scanned in countries (e.g., Germany, France) where the Caps Lock key cannot be used to toggle Caps Lock. The NumLock option works similarly to the regular Autocaps, but uses the NumLock key to retrieve the current state of the Caps Lock.



KBDSTY7.

Autocaps via NumLock

Emulate External Keyboard should be scanned if you do not have an external keyboard (IBM AT or equivalent).



KBDSTY5.

Emulate External Keyboard

Note: After scanning the Emulate External Keyboard bar code, you must power cycle your computer.

Keyboard Conversion

Alphabetic keyboard characters can be forced to be all upper case or all lowercase. So if you have the following bar code: "abc569GK," you can make the output "ABC569GK" by scanning **Convert All Characters to Upper Case**, or to "abc569gk" by scanning **Convert All Characters to Lower Case**. These settings override [Keyboard Style](#) selections.

Default = Keyboard Conversion Off.



KBDCNV0.

*** Keyboard Conversion Off**



KBDCNV1.

Convert All Characters to Upper Case



KBDCNV2.

Convert All Characters to Lower Case

Keyboard Modifiers

This modifies special keyboard features, such as CTRL+ ASCII codes and Turbo Mode.

Control + ASCII Mode On: The scanner sends key combinations for ASCII control characters for values 00-1F (refer to the ASCII chart for [Non-Printable Characters](#), page A-4). Windows is the preferred mode. All keyboard country codes are supported. DOS mode is a legacy mode, and it does not support all keyboard country codes. New users should use the Windows mode.

Windows Mode Prefix/Suffix Off: The scanner sends key combinations for ASCII control characters for values 00-1F (refer to the ASCII chart for [Non-Printable Characters](#), page A-4), but it does not transmit any prefix or suffix information.

Default = Control + ASCII Mode Off.



KBDCAS2.

Windows Mode Control + ASCII Mode On



KBDCAS0.

*** Control + ASCII Mode Off**



KBDCAS1.

DOS Mode Control + ASCII Mode On



KBDCAS3.

Windows Mode Prefix/Suffix Off

Numeric Keypad Mode: Sends numeric characters as if entered from a numeric keypad. *Default = Off.*



KBDNPS1.

Numeric Keypad Mode On



KBDNPS0.

*** Numeric Keypad Mode Off**

Inter-Scan Code Delay

When your keyboard detects that any key is being pressed, released, or held down, the keyboard sends a packet of information known as a “scan code” to your computer. This selection allows you to adjust the delay

between scan codes. Set the length (in milliseconds) for a delay by scanning the bar code below, then setting the delay (from 1-30) by scanning digits from the [Programming Chart](#), then scanning **Save**. *Default = 0 (800 μs).*



KBDDLY.

Inter-Scan Code Delay

<F0> Break Character

When your keyboard detects that any key is being pressed, released, or held down, the keyboard sends a packet of information known as a “scan code” to your computer. There are two different types of scan codes: “make codes” and “break codes.” A make code is sent when a key is pressed or held down. A break code is sent when a key is released. The following selections allow you to suppress or transmit the character sequence of the break code. *Default = Transmit.*



KBDF0B0.

Suppress



KBDF0B1.

*** Transmit**

Keyboard Wedge Defaults

If you want the custom keyboard wedge default settings restored to your scanner, scan the **Keyboard Wedge Defaults** bar code below. This resets the scanner to the custom default settings (see [Setting Custom Defaults](#) on page 1-8). If there are no custom defaults, it will reset the scanner to the factory default settings. Any settings that have not been specified through the custom defaults will be defaulted to the factory default settings.



KBDDFT.

Keyboard Wedge Defaults

RS232 Modifiers

RS232 Baud Rate

Baud Rate sends the data from the scanner to the terminal at the specified rate. The host terminal must be set for the same baud rate as the scanner.
Default = 9600.



232BAD0.

300



232BAD2.

1200



232BAD4.

4800



232BAD6.

19200



232BAD8.

57,600



232BAD1.

600



232BAD3.

2400



232BAD5.

* 9600



232BAD7.

38400



232BAD9.

115,200

RS232 Word Length: Data Bits, Stop Bits, and Parity

Data Bits sets the word length at 7 or 8 bits of data per character. If an application requires only ASCII Hex characters 0 through 7F decimal (text, digits, and punctuation), select 7 data bits. For applications that require use of the full ASCII set, select 8 data bits per character. *Default = 8.*

Stop Bits sets the stop bits at 1 or 2. *Default = 1.*

Parity provides a means of checking character bit patterns for validity. *Default = None.*



232WRD3.

7 Data, 1 Stop, Parity Even



232WRD6.

7 Data, 1 Stop, Parity Odd



232WRD1.

7 Data, 2 Stop Parity None



232WRD5.

8 Data, 1 Stop, Parity Even



232WRD8.

8 Data, 1 Stop, Parity Odd



232WRD0.

7 Data, 1 Stop, Parity None



232WRD4.

7 Data, 2 Stop, Parity Even



232WRD7.

7 Data, 2 Stop, Parity Odd



232WRD2.

* 8 Data, 1 Stop, Parity None



232WRD9.

7 Data, 1 Stop, Parity Space



232WRD10.

7 Data, 2 Stop, Parity Space



232WRD12.

7 Data, 1 Stop, Parity Mark



232WRD14.

8 Data, 1 Stop Parity Mark



232WRD11.

8 Data, 1 Stop, Parity Space



232WRD13.

7 Data, 2 Stop, Parity Mark

RS232 Handshaking

RS232 Handshaking allows control of data transmission from the scanner using software commands from the host device.

RTS/CTS Off: RTS/CTS is turned off so no data flow control is used, but RTS is still active.

RTS/CTS Off, RTS Inactive: RTS/CTS is turned off so no data flow control is used and RTS is inactive.

Flow Control, No Timeout: The scanner asserts RTS when it has data to send, and will wait indefinitely for CTS to be asserted by the host.

Character-Based Flow Control, No Timeout: The scanner asserts RTS when it has a character to send, and will wait indefinitely for CTS to be asserted by the host

Two-Direction Flow Control: The scanner asserts RTS when it is OK for the host to transmit. The host asserts CTS when it is OK for the device to transmit.

Flow Control with Timeout: The scanner asserts RTS when it has data to send and waits for a delay (see [RS232 Timeout](#) on page 2-22) for CTS to be asserted by the host. If the delay time expires and CTS is not asserted, the device transmit buffer is cleared and scanning may resume.

Character-Based Flow Control with Timeout: The scanner asserts RTS when it has a character to send and waits for a delay (see [RS232 Timeout](#) on page 2-22) for CTS to be asserted by the host. If the delay time expires and CTS is not asserted, the device transmit buffer is cleared and scanning may resume.

Default = RTS/CTS Off (Voyager 1200)

RTS/CTS Off, RTS Inactive (Voyager 1202).



232CTS0.

* RTS/CTS Off



232CTS10.

* RTS/CTS Off, RTS Inactive



232CTS1.

Flow Control, No Timeout



232CTS7.

Character-Based Flow Control,
No Timeout



232CTS2.

Two-Direction Flow Control



232CTS3.

Flow Control with Timeout



232CTS9.

Character-Based Flow Control
with Timeout

RS232 Timeout

When using Flow Control with Timeout, you must program the length of the delay you want to wait for CTS from the host. Set the length (in milliseconds) for a timeout by scanning the bar code below, then setting the timeout (from 1-5100 milliseconds) by scanning digits from the [Programming Chart](#), then scanning **Save**. *Default = 1000 ms (1 second).*



232DEL.

RS232 Timeout

XON/XOFF

Standard ASCII control characters can be used to tell the scanner to start sending data (**XON/XOFF On**) or to stop sending data (**XON/XOFF Off**). When the host sends the XOFF character (DC3, hex 13) to the scanner, data transmission stops. To resume transmission, the host sends the XON character (DC1, hex 11). Data transmission continues where it left off when XOFF was sent. *Default = XON/XOFF Off.*



232XON1.
XON/XOFF On



232XOND.
*** XON/XOFF Off**

ACK/NAK

After transmitting data, the scanner waits for an ACK character (hex 06) or a NAK character (hex 15) response from the host. If ACK is received, the communications cycle is completed and the scanner looks for more bar codes. If NAK is received, the last set of bar code data is retransmitted and the scanner waits for ACK/NAK again. Turn on the ACK/NAK protocol by scanning the **ACK/NAK On** bar code below. To turn off the protocol, scan **ACK/NAK Off**. *Default = ACK/NAK Off.*



232ACK1.
ACK/NAK On



232ACKD.
*** ACK/NAK Off**

Communication Timeout

This allows you to set the length (in milliseconds) for a timeout for the host ACK/NAK response. Scan the bar code below, then set the timeout (from 1-65535 milliseconds) by scanning digits from the [Programming Chart](#), then scanning **Save**. *Default = 2000 ms.*



232DLK.
Communication Timeout

Timeout Retries

This setting limits the number of Communication Timeout retries. If the Timeout Retries is set to 0, the transmission is terminated after the initial Communication Timeout. Scan the bar code below, then set the number of retries (from 0-255) by scanning digits from the [Programming Chart](#), then scanning **Save**. (5 is the recommended setting.) *Default = 0.*



HSTRTY.

Timeout Retries

Communication Timeout Beeper

This selection programs the scanner to issue an error beep when a communication timeout has occurred. The error beep sound is programmed using [Number of Beeps – Error](#) (page 4-4). *Default = On.*



HSTTOAD.

Off



HSTTOA1.

*** On**

NAK Retries

This selection limits the number of NAK retries that can occur in ACK/NAK mode. Scan the bar code below, then set the number of retries (from 0-255) by scanning digits from the [Programming Chart](#), then scanning **Save**. (5 is the recommended setting.) *Default = 0, or disabled.*



HSTRTN.

NAK Retries

Support BEL/CAN in ACK/NAK

This protocol responds to <BEL> and <CAN> commands when in ACK/NAK mode. The scanner sounds an error tone when a <BEL> command is sent from the host. <CAN> terminates the transmission. *Default = BEL/CAN Off.*



BELCAN1.
BEL/CAN On



BELCAN0.
* BEL/CAN Off

RS232 Defaults

If you want the custom RS232 default settings restored to your scanner, scan the **RS232 Defaults** bar code below. This resets the scanner to the custom default settings (see [Setting Custom Defaults](#) on page 1-8). If there are no custom defaults, it will reset the scanner to the factory default settings. Any settings that have not been specified through the custom defaults will be restored to the factory default settings.



232DFT.
RS232 Defaults

NCR Modifiers

NCR ACK/NAK

This is an NCR communication protocol for ACK/NAK processing. *Default = NCR ACK/NAK Off.*



NCRACK0.
* NCR ACK/NAK Off



NCRACK1.
NCR ACK/NAK On

Block Check Character

When this selection is set to **Transmit**, the NCR Block Check Character (BCC) is expected with incoming messages and transmitted with outgoing messages. *Default = Transmit.*



NCRBCC1.

* Transmit



NCRBCC0.

Don't Transmit

NCR Prefix

This selection allows you to program an NCR-specific prefix. Refer to the [ASCII Conversion Chart \(Code Page 1252\)](#) on page A-4 to find the hex equivalent for the characters you want for the NCR prefix (typically, 02 for STX). Scan the bar code below, then set the hex number (from 0-FF) by scanning digits from the [Programming Chart](#), then scanning **Save**. *Default = 0.*



NCRPR2.

NCR Prefix

NCR Suffix

This selection allows you to program an NCR-specific suffix. Refer to the [ASCII Conversion Chart \(Code Page 1252\)](#) on page A-4 to find the hex equivalent for the characters you want for the NCR suffix (typically, 03 for ETX). Scan the bar code below, then set the hex number (from 0-FF) by scanning digits from the [Programming Chart](#), then scanning **Save**. *Default = 0.*



NCRSF2.

NCR Suffix

NCR Prefix/Suffix

When set to **Transmit**, both the NCR prefix and suffix are transmitted with bar codes. Usually, prefixes and suffixes are programmed using the Data Editing selections (see [Data Editing](#) beginning on page 5-1), however, the following commands override any other prefix/suffix settings. *Default = Don't Transmit.*



NCRBCP1.

Transmit



NCRBCP0.

*** Don't Transmit**

NCR NOF (Not-on-File) Error

A scanner receives an NOF (Not on File) command from the POS whenever it cannot cross-reference the bar code to a price parameter. When set to **On**, the error tone sounds (set via [Number of Beeps – Error](#), page 4-4) for an NOF, and disables the scanner while the cashier looks up the price manually. When set to **Off**, no sound is emitted for an NOF. *Default = Off.*



NCRRAZ1.

On



NCRRAZ0.

*** Off**

Scanner to Bioptic Communication

The following settings are used to set up communication between Honeywell scanners and bioptic scanners.

Note: The scanner's baud rate must be set to 38400 and the RS232 Timeout must be set to 3000 in order to communicate with a bioptic scanner. See [RS232 Modifiers](#) on page 2-19, and [RS232 Timeout](#) on page 2-22 for further information.

Scanner-Bioptic Packet Mode

Packet Mode On must be scanned to set the scanner's format so it is compatible with a bioptic scanner. *Default = Packet Mode Off.*



232PKT0.

* **Packet Mode Off**



232PKT2.

Packet Mode On

ACK/NAK

After transmitting data, the scanner waits for an ACK character (hex 06) or a NAK character (hex 15) response from the host. If ACK is received, the communications cycle is completed and the scanner looks for more bar codes. If NAK is received, the last set of bar code data is retransmitted and the scanner waits for ACK/NAK again. Turn on the ACK/NAK protocol by scanning the **ACK/NAK On** bar code below. To turn off the protocol, scan **ACK/NAK Off**. *Default = ACK/NAK Off.*



232ACK1.

ACK/NAK On



232ACK0.

* **ACK/NAK Off**

Communication Timeout

This allows you to set the length (in milliseconds) for a timeout for the host ACK/NAK response. Scan the bar code below, then set the timeout (from 1-65535 milliseconds) by scanning digits from the [Programming Chart](#), then scanning **Save**. *Default = 2000 ms.*



232DLK.

Communication Timeout

Cordless System Operation

Note: This chapter applies only to cordless scanning systems. It does not apply to corded scanners.

How the Charge and Communications Base Works

A cordless charge and communications base provides the link between the cordless scanner and the host system. The base contains an interface assembly and an RF communication module. The RF communication module performs the data exchange between the cordless scanner and the interface assembly. The control assembly coordinates the central interface activities including: transmitting/receiving commands and data to/from the host system, performing software activities (parameter menuing, visual indicator support, power-on diagnostics), and data translation required for the host system.

The cordless charge base is also a scanner's battery charger. Refer to [Charging Information](#), page 3-4, for additional information.

Linking the Scanner to a Base

Turn off power before connecting a base, then power up the computer once the base is fully connected. When the base is connected and powered up, put the scanner in the base to establish a link. The red LED on the base lights to indicate power, and the green LED flashes to indicate the scanner's battery is charging.

If the scanner and base have previously been linked, you do not receive any feedback. If this is the first time that the scanner and base are linked, both devices emit a short chirp when their radios link. That indicates that the scanner is linked to the base.

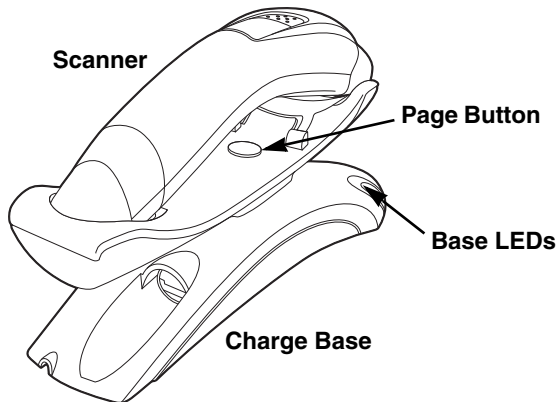

To determine if your cordless system is set up correctly, scan one of the sample bar codes in the back of this manual. If the scanner provides a single good read beep and the green LED lights, the scanner has successfully linked to the base. If you receive an error tone and the red LED lights, the scanner has not linked to the base. Refer to [page 12-5](#) for troubleshooting information.

Communication Between the Cordless System and the Host

The cordless scanner provides immediate feedback in the form of a “good read” indication (a green LED on the scanner and an audible beep) after a bar code is scanned correctly and the base has acknowledged receiving the data. This is possible since the cordless system provides two-way communication between the scanner and the base.

When data is scanned, the data is sent to the host system via the base. The cordless scanner recognizes data acknowledgement (ACK) from the base. If it cannot be determined that the data has been properly sent to the base, the scanner issues an error indication. You must then check to see if the scanned data was received by the host system.

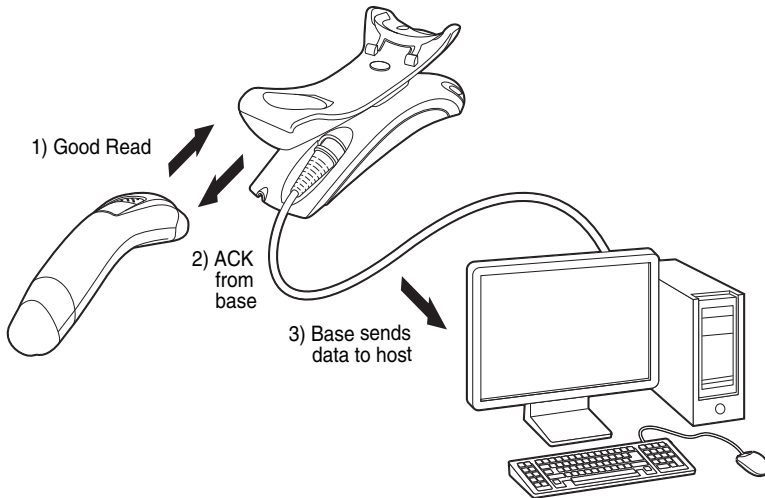

RF (Radio Frequency) Module Operation

The cordless system uses a two-way Bluetooth® radio to transmit and receive data between the scanner and the base. Designed for point-to-point and multi-point-to-single point applications, the radio operates using a license free ISM band. This band sends relatively small data packets at a fast data rate over a radio signal with randomly changing frequencies. This makes the cordless system highly responsive to a wide variety of data collection applications and resis-

tant to noisy RF environments. The Bluetooth Class 2 power level provides a communication range of 33 feet (10m) between the scanner and base, depending on the environment.

System Conditions

The components of the cordless system interact in specific ways as you associate the scanner with its base, as you move a scanner out of range, or bring a scanner back in range. The following information explains the cordless system operating conditions.

Linking Process

Once a scanner is placed into a cordless charge base, the scanner's battery charge status is checked, and software automatically detects the scanner and links it to the base depending on the selected link mode.

Scanner Is Out of Range

The cordless scanner is in communication with its base, even when it is not transmitting bar code data. Whenever the scanner can't communicate with the base for a few seconds, it is out of range. If the scanner is out of range and you scan a bar code, the scanner issues an error tone indicating no communication with the base. A cordless charge base can also sound an alarm. Refer to [Out-of-Range Alarm](#), page 3-12.

Scanner Is Moved Back Into Range

The scanner relinks if the scanner or the base have been reset, or the scanner comes back into range. If the scanner relinks, you will hear a single chirp when the relinking process is complete. Refer to [Out-of-Range Alarm](#) on page 3-12 for further information.

Out of Range and Back into Range with Batch Mode On

The scanner may store a number of symbols (approximately 500 U.P.C. symbols; others may vary) when it is out of range and then send them to the base when back in range (see [Batch Mode](#) on page 3-13).

You will not hear a communication error tone in this mode, but you will hear a short buzz when you press the button if the radio communication is not working. Once the radio connection is made, the scanner produces a series of beeps while the data is being transferred to the base.

Page Button

When you press the Page button on the base, the scanner associated with that base will begin beeping (3 short and 1 long beep). If you press the button on a scanner that is beeping in response, or press the Page button on the base a second time, the scanner will stop beeping. See [Paging](#) on page 3-8 for further information about Page Button settings.

About the Battery



There is a danger of explosion if the batteries are incorrectly replaced. Replace the batteries with only the same or equivalent type recommended by the manufacturer. Dispose of used batteries according to the recycle program for batteries as directed by the governing agency for the country where the batteries are to be discarded.

Power is supplied to the cordless scanner by a rechargeable battery that is integrated in the scanner handle. Batteries are shipped approximately 30% to 60% charged. The battery should be charged for a minimum of 4 hours before initial use to ensure optimal performance.

Voyager 1202g Battery Removal

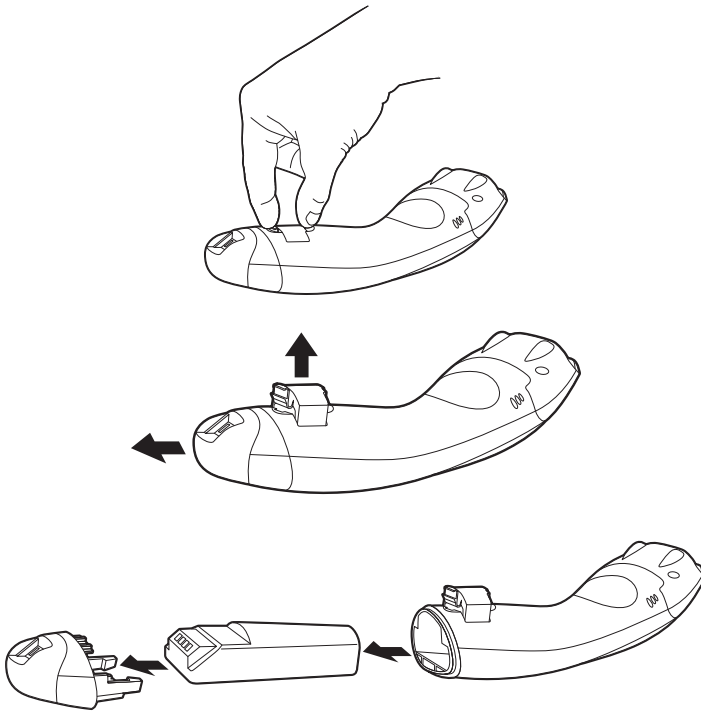

Charging Information

The battery is designed to charge while the scanner is positioned in the base unit. Refer to [Base LED Sequences and Meaning](#), page 3-7, for an interpretation of the Charge Status indicators. Refer to [Charge Only Mode](#) (page 3-10) if you need to charge a scanner without linking it to the base.

The model Voyager 1202g is designed for use with Honeywell battery pack model 100000495 (Li-ion 3.7Vdc, 7.4 watt hour).

Place the scanner in the base that is connected to an appropriate power supply. Use only a Listed Limited Power Source (LPS) or Class 2 type power supply with output rated 5 to 5.2Vdc, 1A.

Note: If you are powering the base through the interface cable (for example, a USB cable) and not using an external power supply plugged into the aux port, the current available for charging is reduced and the charge time is increased.

Battery Recommendations

- The battery is a lithium ion cell and can be used without a full charge, and can also be charged without fully discharging, without impacting the battery life. There is no need to perform any charge/discharge conditioning on this type of battery.
- Keep the base connected to power when the host is not in use.
- Replace a defective battery immediately since it could damage the scanner.
- Although your battery can be recharged many times, it will eventually be depleted. Replace it after the battery is unable to hold an adequate charge.
- If you are not sure if the battery or charger is working properly, send it to Honeywell International Inc. or an authorized service center for inspection. Refer to [Customer Support](#) on page 13-1 for additional information.



Caution:

The model CCB00-010BT base is designed for use with the Honeywell model Voyager 1202g scanner. Use of any non-Honeywell battery may result in damage not covered by the warranty.

Safety Precautions for Lithium Batteries

- Do not place batteries in fire or heat the batteries.
- Do not store batteries near fire or other high temperature locations.
- Do not store or carry batteries together with metal objects.
- Do not expose batteries to water or allow the batteries to get wet.
- Do not connect (short) the positive and negative terminals, of the batteries, to each other with any metal object.
- Do not pierce, strike or step on batteries or subject batteries to strong impacts or shocks.
- Do not disassemble or modify batteries.

**Caution:**

Danger of explosion if batteries are incorrectly replaced. Dispose of used batteries according to the recycle program for batteries as directed by the governing agency for the country where the batteries are to be discarded.

Proper Disposal of the Battery



When the battery has reached the end of its useful life, the battery should be disposed of by a qualified recycler or hazardous materials handler. Do not incinerate the battery or dispose of the battery with general waste materials. You may send the scanner's battery to us (postage paid). The shipper is responsible for complying with all federal, state, and local laws and regulations related to the packing, labeling, manifesting, and shipping of spent batteries. Contact the Product Service Department ([page 13-1](#)) for recycling or disposal information. Since you may find that your cost of returning the batteries significant, it may be more cost effective to locate a local recycle/disposal company.

Flash Updates

The scanner can be flashed either in the base or out of the base, however, it is recommended that you flash the scanner while it is in the base. Flash updates cannot be completed when the scanner is out of the base and the battery is low, or when the scanner is out of range.

Beeper and LED Sequences and Meaning

The scanner contains LEDs on the top that indicate linking status, decoding state, and battery condition. The base has LEDs on the front that indicate its power up, communication, and battery charge condition. The unit's audible indicators have meaning as well. The following table lists the indication and cause of the LED illumination and beeps for the scanner and charge base.

Scanner LED Sequences and Meaning

Note: Pressing the button on the scanner causes the LED to glow red until it communicates successfully with the base.

LED Indication	Beeper Indication	Cause
Normal Operation		
Red Flash	None	Battery low
Green Flash	1 beep	Successful communication or linking
Red, blinking	Razz or error tone	Failed communication
Menu Operation		

LED Indication	Beeper Indication	Cause
Green Flash	2 beeps	Successful menu change
Red, blinking	Razz or error tone	Unsuccessful menu change

Base LED Sequences and Meaning

The base contains a red LED that indicate the status of the unit and verifies its communication with the host system. The base also has a green LED that indicates the scanner battery charge condition.

Red LED - Host Communication	
Red LED	Communication Condition
Off	Power off, USB suspend
On continuously	Power on, system idle
Short blinks. Occurs while transferring data to/from the RF module or the host port.	Receiving data

Green LED - Scanner Battery	
Green LED	Charge Condition
Off	Battery not detected or charge suspended
Slow flash, 1 second on, 1 second off	Pre-charge and charging
On continuously	Charge complete
Fast flash, 300 mSec on, 300 mSec off	Charge Error

Base Power Communication Indicator

To display the power indicator on the base, scan the **Base Power Communication Indicator On** bar code. To turn off the power indicator, scan the **Off** bar code. *Default = On.*



.*:BASRED1.

* Base Power Communication Indicator On



.*:BASREDO.

Base Power Communication Indicator Off

Reset Scanner

Scanning this bar code reboots the scanner and causes it to relink with the base.



Scanning While in Base Cradle

If you want to be able to scan bar codes while the scanner is in the base, scan the following **Scanning in Cradle On** bar code. If you want to only allow scanning when the scanner is out of the base, scan **Scanning in Cradle Off**.

Default = Scanning in Cradle On.



*Note: When **Scanning in Cradle Off** is selected, the scanner will not scan any bar codes while it is in the base. It will only scan when removed from the base.*

Paging

Paging Mode

By default, the paging button on the base pages the scanner associated with that base. If you want the paging button on your base to be disabled, scan the following **Paging Mode Off** bar code. When Paging Mode is off, the base will no longer page the scanner when the button is pressed. The

red LED on the base will remain lit to indicate that Paging Mode is off. (This light will go out when the button is pressed, then back on when it's released.) *Default = Paging Mode On.*



BEPPGE1.

* **Paging Mode On**



BEPPGE0.

Paging Mode Off

Paging Pitch

When you press the Page button on the base, the scanner associated with that base will begin beeping (see [Page Button](#) on page 3-3). You can set the pitch of the paging beep for the scanner by scanning one of the following bar codes. *Default = Low.*



BEPPFQ1000.

* **Low (1000 Hz)**



BEPPFQ3250.

Medium (3250 Hz)



BEPPFQ4200.

High (4200 Hz)

Error Indicators

Scanner Address

Scan the following bar code to determine the address of the scanner you are using.



BT_LDA.

Scanner Address

Base Address

Scan the following bar code to determine the address of the base you are using.



.*:BASLDA.

Base Address

Scanner Modes

The Voyager is capable of working with Bluetooth devices other than the CCB00-010BT charge base.

Charge Only Mode

There may be times when you want to charge your scanner, but not link to the base. For example, if a scanner is linked to a Bluetooth device and you need to charge the scanner, but want to retain your existing link.

In order to program the base for Charge Only Mode, you must link a scanner to it. Once the scanner is linked to the base, scan the **Charge Only Mode** bar code. Any subsequent scanners placed in that base will charge without linking to it. The scanner used to program the base remains linked to the base. To unlink this scanner, scan [Unlink Scanner](#) on page 3-11.



.*:BASLNKD.

Charge Only Mode

Note: When in Charge Only Mode, the scanner periodically wakes up and beeps. See "Power Up Beeper" on page 4-1 to change this setting.

If you want to charge a scanner and link to the base, use **Charge and Link Mode**. If the base is programmed for Charge Only Mode, you must link a scanner to it first in order to program it for Charge and Link Mode. Scan the linking bar code on the base to link the scanner, then scan **Charge and Link Mode**. *Default = Charge and Link Mode.*



.*:BASLNK1.

*** Charge and Link Mode**

Linked Modes

Locked Link Mode and Open Link Mode are the link modes that accommodate different applications. Scan the appropriate bar codes included in the Open Link and Locked Link Mode explanations that follow to switch from one mode to another. *Default = Open Link Mode.*

Locked Link Mode - Single Scanner

If you link a scanner to a base using the Locked Link Mode, other scanners are blocked from being linked if they are inadvertently placed into the base. If you do place a different scanner into a base, it will charge the scanner, but the scanner will not be linked.



:*:BASCOND.

**Locked Link Mode
(Single Scanner)**

To use a different scanner, you need to unlink the original scanner by scanning the **Unlink Scanner** bar code. (See [Scanner Modes](#), page 3-10.)

Open Link Mode - Single Scanner

When newly shipped or defaulted to factory settings, a scanner is not linked to a base. A link is established when the scanner is placed into a base. When in Open Link Mode, a new link is established when a new scanner is placed in the base. Each time a scanner is placed into a base, the scanner becomes the linked to the base and the old scanner is unlinked.



:*:BASCON1.

*** Open Link Mode
(Single Scanner)**

Unlinking the Scanner

If a base has a scanner linked to it, that scanner must be unlinked before a new scanner can be linked. Once the previous scanner is unlinked, it will no longer communicate with the base. To unlink the scanner from a base, scan the following **Unlink Scanner** bar code.



BT_RMV.

Unlink Scanner

Override Locked Scanner

If you need to replace a broken or lost scanner that is linked to a base, scan the following **Override Locked Scanner** bar code with a new scanner and place that scanner in the base. The locked link will be overridden, the broken or lost scanner's link with the base will be removed, and the new scanner will be linked.



BT_RPL1.

**Override Locked Scanner
(Single Scanner)**

Out-of-Range Alarm

If your scanner is out range of the base, an alarm sounds from the scanner. The alarm stops when the scanner is moved closer to the base, when the base connects to another scanner, or when the alarm duration expires.

Note: If you are out of range when you scan a bar code, you will receive an error tone even if you do not have the alarm set. You receive the error tone since the data could not be communicated to the base or the host.

Alarm Sound Type

Set the alarm type for the scanner by scanning the following appropriate bar code. If the alarm is on, the scanner will emit 3 long, high pitched beeps. *Default = Alarm On.*



BT_ORW0.

Alarm Off



BT_ORW1.

*** Alarm On**

Alarm Duration

To set the the length of time you want the Out-of-Range alarm to sound, scan the following bar code and then set the time-out duration (from 0-3000 seconds) by scanning digits on the [Programming Chart](#) inside the back cover, then scanning **Save**. *Default = 1 sec.*



BT_ORD.

Scanner Alarm Duration

Scanner Power Time-Out Timer

Note: Scanner Power Time-out Timer only applies to cordless systems. It does not apply to corded scanners.

When there is no activity within a specified time period, the scanner enters low power mode. Scan the appropriate scanner power time-out bar code to change the time-out duration (in seconds).

If the scanner is not activated during the timer interval, the scanner goes into power down mode. Whenever the scanner is activated, the timer is reset. If [Scanning While in Base Cradle](#) (page 3-8) is disabled, the scanner will still go into power down mode. *Default = 3600 seconds.*



BT_LPT0.
Timer Off



BT_LPT200.
200 seconds



BT_LPT400.
400 seconds



BT_LPT900.
900 seconds



BT_LPT3600.
* 3600 seconds



BT_LPT7200.
7200 seconds

Note: When the scanner is in power down mode, press the scanner's button to power the unit back up. There will be a set of power up beeps and a delay of up to a few seconds for the radio to join. The scanner will then be ready to use.

Batch Mode

Batch mode is used to store bar code data when a scanner is out of range of its base, or when performing inventory. The data is transmitted to the base once the scanner is back in range or when the records are manually transmitted.

Automatic Batch Mode stores bar code data when the scanner is out of range of the base. The data is automatically transmitted to the base once the scanner is back in range. When the scanner's buffer space is full, any bar codes scanned generate an error tone. In order to scan bar codes again, the scanner must be moved back into range of the base so data can be transmitted.

Inventory Batch Mode stores bar code data, whether or not you are in range of the base. To transmit the stored data to the base, either place the scanner in the base, or scan [Transmit Inventory Records](#) (page 3-19). When the scanner's buffer space is full, any bar codes scanned generate an error tone. In order to scan bar codes again, the data must be transmitted to the base.

Default = Batch Mode Off.



BATENA0.

* **Batch Mode Off**



BATENA1.

Automatic Batch Mode



BATENA2.

Inventory Batch Mode

Batch Mode Beep

When scanning in Batch Mode, the scanner beeps every time a bar code is scanned. When **Batch Mode Beep** is **On**, you will also hear a click when each bar code is sent to the host. If you do not want to hear these clicks, scan **Batch Mode Beep Off**. *Default = Batch Mode Beep Off.*



BATBEP0.

* **Batch Mode Beep Off**



BATBEP1.

Batch Mode Beep On

Batch Mode Quantity

When in [Inventory Batch Mode](#) (page 3-14), you may wish to transmit the number of multiple bar codes scanned, rather than a single bar code multiple times. For example, if you scan three bar codes called XYZ with **Batch Mode Quantity Off**, when you transmit your data it will appear as XYZ

three times. Using **Batch Mode Quantity On** and the **Quantity Codes** ([page 3-16](#)), you could output your data as "00003, XYZ" instead. *Default = Batch Mode Quantity Off.*



BATQTY0.

* **Batch Mode Quantity Off**



BATQTY1.

Batch Mode Quantity On

Entering Quantities

Quantity Codes ([page 3-16](#)) allow you to enter a quantity for the last item scanned, up to 9999 (default = 1). Quantity digits are shifted from right to left, so if a 5th digit is scanned, the 1st digit scanned is discarded and the 2nd, 3rd and 4th digits are moved to the left to accommodate the new digit.

For example, if the Quantity 5 bar code is scanned after the quantity has been set to 1234, then the 1 is dropped, the quantity will be 2345.

Example: Add a quantity of 5 for the last item scanned.

1. Scan the item's bar code.
2. Scan the quantity 5 bar code.

Example: Add a quantity of 1,500 for the last item scanned.

1. Scan the item's bar code.
2. Scan the quantity 1 bar code.
3. Scan the quantity 5 bar code.
4. Scan the quantity 0 bar code.
5. Scan the quantity 0 bar code.

Example: Change a quantity of 103 to 10.

To correct an incorrect quantity, scan the quantity 0 bar code to replace the incorrect digits, then scan the correct quantity bar codes.

1. Scan the quantity 0 bar code to change the quantity to 1030.
2. Scan the quantity 0 bar code to change the quantity to 0300.
3. Scan the quantity 1 bar code to change the quantity to 3001.
4. Scan the quantity 0 bar code to change the quantity to 0010.

Quantity Codes



BATNUM0.

0



BATNUM2.

2



BATNUM4.

4



BATNUM6.

6



BATNUM8.

8



BATNUM1.

1



BATNUM3.

3



BATNUM5.

5



BATNUM7.

7



BATNUM9.

9

Delete Last Code

If you want to delete the last bar code scanned when in Batch Mode, scan **Delete Last Code**.



BATUND.

Delete Last Code

Record Counter

If you wish to add a record counter to each bar code scanned in Batch Mode, scan **Record Counter On**. Your batch output would add a sequential number before each bar code, for example:

00001,bar code 1

00002,bar code 2

Default = Record Counter Off.



BATENTO.

*** Record Counter Off**



BATENT1.

Record Counter On

Total Records

If you wish to output the total number of bar codes scanned when in Batch Mode, scan **Total Records**.



BATNRC.

Total Records

Batch Mode Output Order

When batch data is transmitted, select whether you want that data sent as **FIFO** (first-in first-out), or **LIFO** (last-in first-out). *Default = Batch Mode FIFO.*



BATLIFO.

* Batch Mode FIFO



BATLIF1.

Batch Mode LIFO

Clear All Codes After Transmission

If you want to clear the scanner's buffer of all data accumulated in Batch Mode *after* the data has been transmitted to the host system, scan **Clear All Codes After Transmission**. If you do not want the buffer cleared after transmission, scan **Don't Clear All Codes After Transmission**. *Default = Don't Clear All Codes After Transmission.*



BATCLXD.

* Don't Clear All Codes After
Transmission



BATCLX1.

Clear All Codes After
Transmission

Clear All Codes

If you want to clear the scanner's buffer of all data accumulated in Batch Mode, scan **Clear All Codes**.



BATCLR.

Clear All Codes

Transmit Records Automatically

If you are operating in Inventory Batch Mode (see [Inventory Batch Mode](#) on page 3-14), you can transmit all stored data to the host system when the scanner is placed in the base. If you don't want the records transmitted when the scanner is placed in the base, scan the **Don't Transmit Records Automatically** bar code. *Default = Don't Transmit Records Automatically.*



BATATX0.

*** Don't Transmit Records
Automatically**



BATATX1.

Transmit Records Automatically

Transmit Records to Host

If you are operating in Inventory Batch Mode (see [Inventory Batch Mode](#) on page 3-14), and your scanner is set to **Don't Transmit Records Automatically**, you must scan the following bar code to transmit all stored records to the host system.



BAT_TX.

Transmit Inventory Records

Batch Mode Transmit Delay

Sometimes when accumulated scans are sent to the host system, the transmission of those scans is too fast for the application to process. To program a transmit delay between accumulated scans, scan one of the following delays. *Default = Off.*

Note: In most cases, a short (250 ms (milliseconds)) delay is ideal, however, longer delays may be programmed. Contact Technical Support (page 13-2) for additional information.



BATDLY0.

* Batch Mode Transmit Delay Off
(No Delay)



BATDLY250.

Batch Mode Transmit Delay Short
(250 ms)



BATDLY500.

Batch Mode Transmit Delay Medium
(500 ms)



BATDLY1000.

Batch Mode Transmit Delay Long
(1000 ms)

Scanner Name

You may assign a name to each scanner you are using for identification purposes. The default name is "Voyager."

Perform the rename operation using either the bar codes on [page 3-21](#), or by sending the serial command **:Voyager:BT_NAMname**, where *name* is the new name for the scanner. If you wish to change the names of additional scanners, link them to the base one at a time and repeat the **:Voyager:BT_NAMname** command for each scanner.

To rename scanners with sequential, numeric names, scan the following bar codes. Scan the **Reset** code after each name change and wait for the scanner to relink to the base.



BT_NAM0001.
0001



BT_NAM0002.
0002



BT_NAM0003.
0003



BT_NAM0004.
0004



BT_NAM0005.
0005



BT_NAM0006.
0006



BT_NAM0007.
0007



RESET_
Reset

You may also scan the following **Scanner Name** bar code and scan up to 30 numbers and/or letters for the scanner name. For example, if you wanted to name the linked scanner “312,” you would scan the following bar code, scan the **3**, **1**, and **2** bar codes on the [Programming Chart](#) inside the back cover of this manual, then scan **Save**. Scan the **Reset** bar code and wait for the scanner to relink to the base.

To output the name of the scanner, scan the following bar code. The name will be output showing the product name, model number, and the scanner’s 10-digit serial number.



BT_NAM.
Scanner Name

Using the Scanner with Bluetooth Devices

The scanner can be used either with the CCB00-010BT charge base or with other Bluetooth devices. Those devices include personal computers and laptops.

Scanning the following **Non-Base BT Connection** bar code allows the scanner to be used with other Bluetooth devices (e.g., PC/laptop). After you scan the **Non-Base BT Connection** bar code, follow the instructions supplied with your Bluetooth device to locate the scanner and connect to it.

Note: If you go out of range with your scanner, the scanner will not reconnect to the Bluetooth device when it is back in range.

To relink to the charge base, scan the **Base BT Connection** bar code.



BT_DNG9.
Non-Base BT Connection



BT_DNG8.
Base BT Connection

Changing the Scanner's Bluetooth PIN Code

Some devices require a PIN code as part of the Bluetooth security features. Your scanner's default PIN is 0000, which you may need to enter the first time you connect to your non-base Bluetooth device. To change the PIN, scan the following bar code and then scan the appropriate numeric bar codes from the [Programming Chart](#) inside the back cover of this manual. (The PIN code must be between 1 and 16 characters.) Scan **Save** to save your selection. *Default = 0000.*



BT_PIN.
Bluetooth PIN

Minimizing Bluetooth/ISM Band Network Activity

The following settings can help you customize the relinking behavior of the cordless system to obtain the best compromise between convenience and low interference.

Note: ISM band refers to the 2.4 to 2.48 GHz frequency band used by wireless networks, cordless phones, and Bluetooth.

Auto Reconnect Mode

Auto Reconnect controls whether or not the scanner automatically begins the relink process when a loss of connection is detected. When the **Auto Reconnect On** bar code is scanned, the scanner begins the relink process immediately, without user intervention. *Default = Auto Reconnect On.*



BT_ACM1.
* Auto Reconnect On



BT_ACM0.
Auto Reconnect Off

The following table shows the results of the Auto Reconnect On and Off settings:

Event	Auto Reconnect On	Auto Reconnect Off
Scanner out of range	Relink occurs automatically. If maximum number of link attempts is unsuccessful, then the scanner must be relinked by either pressing the scanner's button or placing the scanner in the base. (See Maximum Link Attempts on page 3-24.)	The scanner is relinked by pressing the button.
Base reset (firmware upgrade or power cycle)	Scanner behaves as if out of range.	No attempt to relink made while base is powered off. Button must be pressed to initiate relinking.
Scanner reset due to firmware upgrade	Relink occurs automatically.	
Scanner reset due to battery change	Relink occurs automatically.	
Scanner placed in different base unit	Relink to new base occurs automatically.	

Maximum Link Attempts

The Maximum Link Attempts setting controls the number of times the scanner tries to form a connection with a base. During the connection setup process, the scanner transmits in order to search for and connect to a base. In order to prevent continuous transmissions that could interfere with other users of the ISM band, the number of attempts to connect is limited by this setting. After the maximum number of attempts is reached, the scanner will not attempt to reconnect to a base. Pressing the scanner's button or placing the scanner in the base resets the attempt count and the scanner will again try to link.

Scan the **Maximum Link Attempts** bar code, then scan the number of attempts for the setting (from 0-255) from the inside back cover. Scan **Save** to save the setting. *Default = 0.*



BT_MLA.

Maximum Link Attempts

Note: When Auto Reconnect Mode is On, setting Maximum Link Attempts to zero will cause the scanner to try to link until the Power Time-Out Timer setting (see [page 3-13](#)) expires. When Auto Reconnect Mode is Off, setting Maximum Link Attempts to zero will cause the scanner to only attempt linking one time after a button press.

Relink Time-Out

Relink Time-Out controls the idle time between relink attempts. An attempt to link a scanner to a base typically lasts up to 5 seconds. This is the time when the scanner is actually attempting a contact. Relink Time-Out controls the amount of time, in seconds, that elapses between the end of one connection attempt and the start of the next.

Scan the **Relink Time-Out** bar code, then scan the number of seconds for the setting (from 1-100) from the inside back cover. Scan **Save** to save the setting. *Default = 3 seconds.*



BT_RLT.

Relink Time-Out

Bluetooth/ISM Network Activity Examples

Default values

When the scanner goes out of range, the scanner repeatedly attempts to connect to the base unit. Each attempt consists of approximately 5 seconds of active time followed by 3 seconds of idle time. After one hour, the scanner powers off and batch mode data is lost.

Maximum Link Attempts set to 15
Other values at default settings

When the scanner goes out of range, 15 attempts are made to link to the base unit. Each attempt consists of approximately 5 seconds of active time followed by 3 seconds of idle time. After 15 cycles (8*15 =120), or about 2 minutes, the scanner stops trying to connect to the base, but retains any bar codes that may have been saved in batch mode. After one hour, the scanner powers off and batch mode data is lost.

Auto Reconnect Mode set to 0
Maximum Link Attempts set to 15
Other values at default settings

When the scanner goes out of range, no action is taken to relink. When the scanner's button is pressed, 15 attempts are made to link to the base. Each attempt consists of approximately 5 seconds of active time followed by 3 seconds of idle time. After 15 cycles (8*15 =120), or about 2 minutes, the scanner stops trying to connect to the base, but retains any bar codes that may have been saved in batch mode. After one hour, the scanner powers off and batch mode data is lost. Refer to [Auto Reconnect Mode](#), page 3-23, to review other events that can start the relink process.

Reset Scanner and Base

After changing settings, you may need to reset your scanner and base. Scan the **Reset Base** bar code and wait for the scanner to unlink and relink to a base. Once that is done, scan the **Reset Scanner** bar code and wait for the base to unlink and relink to the scanner.



RESET_
Reset Scanner



: * : RESET _ . 3
Reset Base



Input/Output Settings

Power Up Beeper

The scanner can be programmed to beep when it's powered up. Scan the **Off** bar code(s) if you don't want a power up beep. *Default = Power Up Beeper On - Scanner.*



BEPPWR0.

**Power Up Beeper Off -
Scanner**



BEPPWR1.

*** Power Up Beeper On -
Scanner**

Beep on BEL Character

You may wish to force the scanner to beep upon a command sent from the host. If you scan the following **Beep on BEL On** bar code, the scanner will beep every time a BEL character is received from the host. *Default = Beep on BEL Off.*



BELBEP0.

***Beep on BEL Off**



BELBEP1.

Beep on BEL On

Good Read and Error Indicators

Beeper – Good Read

The beeper may be programmed **On** or **Off** in response to a good read. Turning this option off, only turns off the beeper response to a good read indication. All error and menu beeps are still audible. *Default = Beeper - Good Read On.*



BEPBEP0.

Beeper - Good Read Off



BEPBEP1.

*** Beeper - Good Read On**

Beeper Volume – Good Read

The beeper volume codes modify the volume of the beep the scanner emits on a good read. *Default = High.*



BEPLVL1.

Low



BEPLVL2.

Medium



BEPLVL3.

*** High**



BEPLVL0.

Off

Beeper Pitch – Good Read

The beeper pitch codes modify the pitch (frequency) of the beep the scanner emits on a good read. *Default = Medium.*



BEPFQ11600.
Low (1600 Hz)



BEPFQ12350.
* Medium (2350 Hz)



BEPFQ14200.
High (4200 Hz)

Beeper - Transmit Order

The beeper transmit order determines when the good read beep occurs. The scanner can be set to emit the good read beep either before or after data transmission. *Default = Before Transmission.*



BEPWHN1.
* Before Transmission



BEPWHN2.
After Transmission

Beeper Pitch – Error

The beeper pitch codes modify the pitch (frequency) of the sound the scanner emits when there is a bad read or error. *Default = Razz.*



BEPFQ2100.
* Razz (100 Hz)



BEPFQ22000.
Medium (2000 Hz)



BEPFQ24200.
High (4200 Hz)

Beeper Duration – Good Read

The beeper duration codes modify the length of the beep the scanner emits on a good read. *Default = Normal.*



BEPBIP0.

* Normal Beep



BEPBIP1.

Short Beep

Number of Beeps – Good Read

The number of beeps of a good read can be programmed from 1 - 9. The same number of beeps will be applied to the beeper and LED in response to a good read. For example, if you program this option to have five beeps, there will be five beeps and five LED flashes in response to a good read. The beeps and LED flashes are in sync with one another.

Note: The LEDs can also be programmed separately. See [LED Settings](#) on page 4-6.

To change the number of beeps, scan the following bar code and then scan a digit (1-9) bar code and the **Save** bar code on the [Programming Chart](#) inside the back cover of this manual. *Default = 1.*



BEPRPT.

Number of Good Read Beeps/LED Flashes

Number of Beeps – Error

The number of beeps and LED flashes emitted by the scanner for a bad read or error can be programmed from 1 - 9. For example, if you program this option to have five error beeps, there will be five error beeps and five LED flashes in response to an error.

Note: The LEDs can also be programmed separately. See [LED Settings](#) on page 4-6.

To change the number of error beeps, scan the following bar code and then scan a digit (1-9) bar code and the **Save** bar code on the [Programming Chart](#) inside the back cover of this manual. *Default = 1.*



BEPERR.

Number of Error Beeps/LED Flashes

LED Indicators

The green and red LEDs can be programmed to be On or Off and at different brightness levels to indicate various scanner states. Use the following bar codes to program the LED indicators.

LED Settings

Default = Red LED On with Laser, Green LED On with Good Scan.



LEDFN10.
Red LED Off



LEDFN11.
Red LED On with Good Scan



LEDFN12.
*** Red LED On with Laser**



LEDFN14.
Red LED On when CodeGate Disabled



LEDFN18.
Red LED On when In-Stand



LEDFN20.
Green LED Off



LEDFN21.
*** Green LED On with Good Scan**



LEDFN22.
Green LED On with Laser



LEDFN24.
Green LED On when CodeGate Disabled



LEDFN28.
Green LED On when In-Stand



LEDFN1128.
Red LED On with CTS



LEDFN2128.
Green LED On with CTS



LEDFN11024.
Red LED On when Battery is Low



LEDFN21024.
Green LED On when Battery is Low

LED Brightness

Default = Red High, Green High.



LEDIN10.
Red Off



LEDIN11.
Red Low



LEDIN12.
Red Medium



LEDIN13.
* Red High



LEDIN20.
Green Off



LEDIN21.
Green Low



LEDIN22.
Green Medium



LEDIN23.
* Green High

In-Stand and Out-Of-Stand Settings

The following settings program the scanner's behavior when it is either in the stand, or out of the stand (hand-held).

Caution: When working with In-Stand and Out-of-Stand settings, enable the settings you want before disabling those you do not want to use. If you disable settings first, you may program the scanner so it is unable to read bar codes. If this happens, power cycle the scanner and scan the defaults bar code on [page 1-9](#).

In-Stand and Out-of-Stand Defaults

If you want the In-Stand or Out-of-Stand default settings restored to your scanner, scan the appropriate **Defaults** bar code below. They reset the scanner to the custom default settings (see [Setting Custom Defaults](#) on page 1-8). If there are no custom defaults, it will reset the scanner to the factory default settings. Any settings that have not been specified through the custom defaults will be defaulted to the factory default settings.



AISDFT.

In-Stand Defaults



AOSDFT.

Out-of-Stand Defaults

Presentation Modes

When the scanner is in the stand, by default, bar codes are automatically read when they are detected in the scanner's field of view. When the scanner is out of the stand, by default you must push the button on top of the scanner to read a bar code. Use the following commands to adjust how the scanner behaves when it is out of the stand.

Note: If you are using a cordless charge base in Presentation Mode, the battery will not charge unless the power supply is plugged into the base's auxiliary power port.

Presentation Mode Out-of-Stand: When the scanner is not in the stand, it automatically detects bar codes, then scans and transmits the data. The laser turns off afterward. (If you are accustomed to a Voyager 9520, this setting is the same as the 9520's default.)

Presentation Mode with CodeGate® Out-of-Stand: When the scanner is not in the stand, it automatically detects bar codes and decodes them. However, the data is not transmitted until you press the button. The laser remains on briefly after the transmission. (If you are accustomed to a Voyager 9540, this setting is the same as the 9540's default.)



PAPPM1.

**Presentation Mode
Out-of-Stand**



PAPPM2.

**Presentation Mode with
CodeGate Out-of-Stand**

Manual Activation Mode

In Manual Activation Mode, you must press the button to scan a bar code. The scanner scans until a bar code is read, or until the button is released. *Default = Manual Activation Mode On In-Stand, Manual Activation On Out-of-Stand.*



AISMEND.

**Manual Activation Mode Off
In-Stand**



AISMEN1.

*** Manual Activation Mode On
In-Stand**



AOSMEND.

**Manual Activation Mode Off
Out-of-Stand**



AOSMEN1.

*** Manual Activation Mode On
Out-of-Stand**

End Manual Activation After Good Read

After a bar code is successfully read, the laser can be programmed either to remain on and scanning, or to turn off. When **End Manual Activation After Good Read** is enabled, the laser turns off and stops scanning after a good read. If you scan **Do Not End Manual Activation After Good Read**, the laser remains on after a good read, but the button must be pressed to scan the next bar code. *Default = End Manual Activation After Good Read.*



AISMGDD.

**Do Not End Manual Activation
After Good Read In-Stand**



AISMGD1.

*** End Manual Activation After
Good Read In-Stand**



AOSMGDD.

**Do Not End Manual Activation
After Good Read Out-of-Stand**



AOSMGD1.

*** End Manual Activation After
Good Read Out-of-Stand**

Manual Activation Laser Timeout - Button Settings

You can set a timeout for the length of time the laser remains on and attempting to decode bar codes when the button is held down, and after it is released. Set the length (in milliseconds) for a timeout by scanning one of the following bar codes, then setting the timeout (from 1-65535 milliseconds) by scanning digits from the [Programming Chart](#), then scanning [Save](#). *Default = Button Hold In-Stand 5000 ms, Button Hold Out-of-Stand 5000 ms, Button Release In or Out-of-Stand 0.*



AISMPT.

**Laser Timeout - Button Hold
In-Stand**



AOSMPT.

**Laser Timeout - Button Hold
Out-of-Stand**



AISMRT.

**Laser Timeout - Button
Release In-Stand**



AOSMRT.

**Laser Timeout - Button
Release Out-of-Stand**

CodeGate®

When CodeGate is **On**, the button is used to allow decoded data to be transmitted to the host system. The scanner remains on, scanning and decoding bar codes, but the bar code data is not transmitted until the button is pressed. When CodeGate is **Off**, bar code data is transmitted when it is decoded. *Default = CodeGate Off in-Stand, CodeGate On Out-of-Stand.*



AISCGD0.

* **CodeGate Off
In-Stand**



AISCGD1.

**CodeGate On
In-Stand**



AOSCGD0.

**CodeGate Off
Out-of-Stand**



AOSCGD1.

* **CodeGate On
Out-of-Stand**

Object Detection Mode

Object Detection Mode uses an LED to detect when an object is in the scanner's field of view. When an object is detected, the laser turns on and the scanner attempts to scan the bar code. *Default = Object Detection Mode On In-Stand.*



AISOEND.

**Object Detection Mode Off
In-Stand**



AISOEN1.

* **Object Detection Mode On
In-Stand**



AOSOEND.

* **Object Detection Mode Off
Out-of-Stand**



AOSOEN1.

**Object Detection Mode On
Out-of-Stand**

End Object Detection After Good Read

After a bar code is successfully detected and read from the scanner, the laser can be programmed either to remain on and scanning, or to turn off. When **End Object Detection After Good Read** is enabled, the laser turns off and stops scanning after a good read. If you scan **Do Not End Object Detection After Good Read**, the laser remains on after a good read. *Default = End Object Detection After Good Read.*



AISOGD0.

**Do Not End Object Detection
After Good Read In-Stand**



AISOGD1.

*** End Object Detection After
Good Read In-Stand**



AOSOGD0.

**Do Not End Object Detection
After Good Read Out-of-Stand**



AOSOGD1.

*** End Object Detection After
Good Read Out-of-Stand**

Object Detection Laser Timeout

You can set a timeout for the length of time the laser remains on and attempting to decode bar codes after an object is detected. Set the length (in milliseconds) for a timeout by scanning the following bar code, then setting the timeout (from 1-65535 milliseconds) by scanning digits from the [Programming Chart](#), then scanning **Save**. *Default = 5000 ms.*



AISODT.

**Object Detection Laser
Timeout In-Stand**



AOSODT.

**Object Detection Laser
Timeout Out-of-Stand**

Object Detection Distance

When the scanner is in the stand and you are using Object Detection Mode, you can set the distance range for detecting objects. **Short** sets the scanner to detect objects approximately 5 inches (12.7cm) away from the nose. **Long** sets it to detect objects approximately 10 inches (25.4cm) away. *Default = Short In-Stand, Long Out-of-Stand.*



AISRNG2.

* **Short
In-Stand**



AISRNG1.

**Long
In-Stand**



AOSRNG2.

**Short
Out-of-Stand**



AOSRNG1.

* **Long
Out-of-Stand**

Character Activation Mode

You may use a character sent from the host to trigger the scanner to begin scanning. When the activation character is received, the scanner continues scanning until either the [Character Activation Laser Timeout](#) (page 4-15), the deactivation character is received (see [Deactivation Character](#) on page 4-16), or a bar code is transmitted. Scan the following **On** bar code to use character activation, then use Activation Character (following) to select the character you will send from the host to start scanning. *Default = Off.*



HSTCEN0.

* **Off**



HSTCEN1.

On

Activation Character

This sets the character used to trigger scanning when using Character Activation Mode. On the [ASCII Conversion Chart \(Code Page 1252\)](#), page A-4, find the hex value that represents the character you want to use to

trigger scanning. Scan the following bar code, then use the [Programming Chart](#) to read the alphanumeric combination that represents that ASCII character. Scan **Save** to finish.



HSTACH.

Activation Character

End Character Activation After Good Read

After a bar code is successfully detected and read from the scanner, the laser can be programmed either to remain on and scanning, or to turn off. When **End Character Activation After Good Read** is enabled, the laser turns off and stops scanning after a good read. If you scan **Do Not End Character Activation After Good Read**, the laser remains on after a good read. *Default = End Character Activation After Good Read.*



HSTCGD0.

**Do Not End Character Activation
After Good Read**



HSTCGD1.

*** End Character Activation After
Good Read**

Character Activation Laser Timeout

You can set a timeout for the length of time the laser remains on and attempting to decode bar codes when using Character Activation Mode. Set the length (in milliseconds) for a timeout by scanning the following bar code, then setting the timeout (from 1-65535 milliseconds) by scanning digits from the [Programming Chart](#), then scanning **Save**. *Default = 5000 ms.*



HSTCDT.

**Character Activation Laser
Timeout**

Character Deactivation Mode

If you have sent a character from the host to trigger the scanner to begin scanning, you can also send a deactivation character to stop scanning. Scan the following **On** bar code to use character deactivation, then use Deactivation Character (following) to select the character you will send from the host to terminate scanning. *Default = Off.*



HSTDEN0.
* Off



HSTDEN1.
On

Deactivation Character

This sets the character used to terminate scanning when using Character Deactivation Mode. On the [ASCII Conversion Chart \(Code Page 1252\)](#), page A-4, find the hex value that represents the character you want to use to terminate scanning. Scan the following bar code, then use the [Programming Chart](#) to read the alphanumeric combination that represents that ASCII character. Scan **Save** to finish.



HSTDCH.
Deactivation Character

Reread Delay

This sets the time period before the scanner can read the *same* bar code a second time. Setting a reread delay protects against accidental rereads of the same bar code. Longer delays are effective in minimizing accidental rereads. Use shorter delays in applications where repetitive bar code scanning is required. *Default = Medium.*



DLYRRD500.

Short (500 ms)



DLYRRD750.

* Medium (750 ms)



DLYRRD1000.

Long (1000 ms)



DLYRRD2000.

Extra Long (2000 ms)

User-Specified Reread Delay

If you want to set your own length for the reread delay, scan the following bar code, then set the delay (from 0-30,000 milliseconds) by scanning digits from the [Programming Chart](#), then scanning [Save](#).



DLYRRD.

User-Specified Reread Delay

Output Sequence Overview

Require Output Sequence

When turned off, the bar code data will be output to the host as the scanner decodes it. When turned on, all output data must conform to an edited sequence or the scanner will not transmit the output data to the host device. See [Require Output Sequence](#) on page 4-21 for further information.

Output Sequence Editor

This programming selection allows you to program the scanner to output data (when scanning more than one symbol) in whatever order your application requires, regardless of the order in which the bar codes are scanned. Reading the **Default Sequence** symbol programs the scanner to the following Universal values. These are the defaults. Be **certain** you want to delete or clear all formats before you read the **Default Sequence** symbol.

Note: If CodeGate is enabled, you must hold the button down while reading each bar code in a sequence.

Note: To make Output Sequence Editor selections, you'll need to know the code I.D., code length, and character match(es) your application requires. Use the Alphanumeric symbols on the [Programming Chart](#) to read these options.

To Add an Output Sequence

1. Scan the **Enter Sequence** symbol (see [Require Output Sequence](#), page 4-21).
2. **Code I.D.**
On the [Symbology Chart](#) on page A-1, find the symbology to which you want to apply the output sequence format. Locate the Hex value for that symbology and scan the 2 digit hex value from the [Programming Chart](#) (inside back cover).
3. **Length**
Specify what length (up to 9999 characters) of data output will be acceptable for this symbology. Scan the four digit data length from the [Programming Chart](#). (Note: 50 characters is entered as 0050. 9999 is a universal number, indicating all lengths.) When calculating the length, you must count any programmed prefixes, suffixes, or formatted characters as part of the length (unless using 9999).
4. **Character Match Sequences**
On the [ASCII Conversion Chart \(Code Page 1252\)](#), page A-4, find the Hex value that represents the character(s) you want to match. Use the [Programming Chart](#) to read the alphanumeric combination that represents the ASCII characters. (99 is the Universal number, indicating all characters.)
5. **End Output Sequence Editor**
Scan **FF** to enter an Output Sequence for an additional symbology, or **Save** to save your entries.

Other Programming Selections

- **Discard**
This exits without saving any Output Sequence changes.

Output Sequence Example

In this example, you are scanning Code 93, Code 128, and Code 39 bar codes, but you want the scanner to output Code 39 1st, Code 128 2nd, and Code 93 3rd, as shown below.

Note: Code 93 must be enabled to use this example.



A - Code 39



B - Code 128



C - Code 93

You would set up the sequence editor with the following command line:

```
SEQBLK62999941FF6A999942FF69999943FF
```

The breakdown of the command line follows:

SEQBLKsequence editor start command

62 code identifier for **Code 39**

9999 code length that must match for Code 39, 9999 = all lengths

41 start character match for Code 39, 41h = "A"

FF termination string for first code

6A code identifier for **Code 128**

9999 code length that must match for Code 128, 9999 = all lengths

42 start character match for Code 128, 42h = "B"

FF termination string for second code

69 code identifier for **Code 93**

9999 code length that must match for Code 93, 9999 = all lengths

43 start character match for Code 93, 43h = "C"

FF termination string for third code

To program the previous example using specific lengths, you would have to count any programmed prefixes, suffixes, or formatted characters as part of the length. If you use the example on [page 4-19](#), but assume a <CR> suffix and specific code lengths, you would use the following command line:

```
SEQBLK62001241FF6A001342FF69001243FF
```

The breakdown of the command line follows:

SEQBLKsequence editor start command

62 code identifier for **Code 39**

0012 A - Code 39 sample length (11) plus CR suffix (1) = 12

41 start character match for Code 39, 41h = "A"

FF termination string for first code

6A code identifier for **Code 128**

0013 B - Code 128 sample length (12) plus CR suffix (1) = 13

42 start character match for Code 128, 42h = "B"

FF termination string for second code

69 code identifier for **Code 93**

0012 C - Code 93 sample length (11) plus CR suffix (1) = 12

43 start character match for Code 93, 43h = "C"

FF termination string for third code

Output Sequence Editor



SEQBLK.

Enter Sequence



SEQDFT.

Default Sequence

Sequence Timeout

You may wish to set the maximum time between bar code scans in an output sequence. If that maximum time is not met, the output sequence operation is terminated. Set the length (in milliseconds) for a timeout by scanning the following bar code, then setting the timeout (from 1-65535 milliseconds) by scanning digits from the [Programming Chart](#), then scanning **Save**. *Default = 5000 msec.*



SEQDLY.

Sequence Timeout

Sequence Match Beeper

By default, the scanner beeps when a sequence match is found. If you want the scanner to remain silent, scan the following **Sequence Match Beeper Off** bar code. *Default = Sequence Match Beeper On.*



SEQBEP0.

Sequence Match Beeper Off



SEQBEP1.

* Sequence Match Beeper On

Partial Sequence

If an output sequence operation is terminated before all your output sequence criteria are met, the bar code data acquired to that point is a "partial sequence."

Scan **Discard Partial Sequence** to discard partial sequences when the output sequence operation is terminated before completion.

Scan **Transmit Partial Sequence** to transmit partial sequences. (Any fields in the sequence where no data match occurred will be skipped in the output.) If you have programmed a [Sequence Timeout](#) (page 4-20) and the timeout is reached, the partial sequence is transmitted. *Default = Discard Partial Sequence.*



SEQTTS1.

Transmit Partial Sequence



SEQTTS0.

* Discard Partial Sequence

Require Output Sequence

When an output sequence is **Required**, all output data must conform to an edited sequence or the scanner will not transmit the output data to the host device. When it's **On/Not Required**, the scanner will attempt to get the output data to conform to an edited sequence but, if it cannot, the scanner transmits all output data to the host device as is.

When the output sequence is **Off**, the bar code data is output to the host as the scanner decodes it. *Default = Off.*



SEQ_EN2.
Required



SEQ_EN1.
On/Not Required



SEQ_EN0.
*Off

No Read

With No Read turned **On**, the scanner notifies you if a code cannot be read. If using an EZConfig-Scanning Tool Scan Data Window (see page 9-2), an “NR” appears when a code cannot be read. If No Read is turned **Off**, the “NR” will not appear. *Default = Off.*



SHWNRD1.
On



SHWNRD0.
* Off

If you want a different notation than “NR,” for example, “Error,” or “Bad Code,” you can edit the output message (see [Data Formatting](#) beginning on page 6-1). The hex code for the No Read symbol is 9C.

Prefix/Suffix Overview

When a bar code is scanned, additional information is sent to the host computer along with the bar code data. This group of bar code data and additional, user-defined data is called a “message string.” The selections in this section are used to build the user-defined data into the message string.

Prefix and Suffix characters are data characters that can be sent before and after scanned data. You can specify if they should be sent with all symbologies, or only with specific symbologies. The following illustration shows the breakdown of a message string:

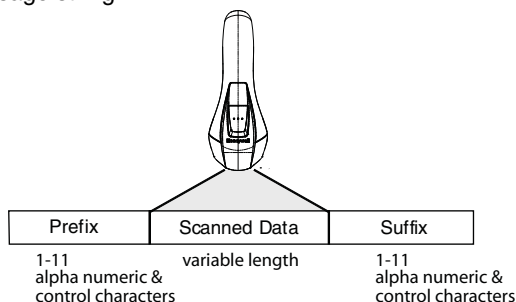

Points to Keep In Mind

- It is not necessary to build a message string. The selections in this chapter are only used if you wish to alter the default settings. *Default prefix = None. Default suffix is dependent on interface.*
- A prefix or suffix may be added or cleared from one symbology or all symbologies.
- You can add any prefix or suffix from the [ASCII Conversion Chart \(Code Page 1252\)](#), beginning on page A-4, plus Code I.D. and AIM I.D.
- You can string together several entries for several symbologies at one time.
- Enter prefixes and suffixes in the order in which you want them to appear on the output.
- When setting up for specific symbologies (as opposed to all symbologies), the specific symbology ID value counts as an added prefix or suffix character.
- The maximum size of a prefix or suffix configuration is 32 characters, which includes header information.

To Add a Prefix or Suffix:

- Step 1.** Scan the **Add Prefix** or **Add Suffix** symbol ([page 5-3](#)).
- Step 2.** Determine the 2 digit Hex value from the Symbology Chart (included in the [Symbology Chart](#), beginning on page A-1) for the

symbology to which you want to apply the prefix or suffix. For example, for Code 128, Code ID is “j” and Hex ID is “6A”.

- Step 3.** Scan the 2 hex digits from the [Programming Chart](#) inside the back cover of this manual or scan **9, 9** for all symbologies.
- Step 4.** Determine the hex value from the [ASCII Conversion Chart \(Code Page 1252\)](#) on page A-4, for the prefix or suffix you wish to enter.
- Step 5.** Scan the 2 digit hex value from the [Programming Chart](#) inside the back cover of this manual.
- Step 6.** Repeat Steps 4 and 5 for every prefix or suffix character.
- Step 7.** To add the Code I.D., scan **5, C, 8, 0**.
To add AIM I.D., scan **5, C, 8, 1**.
To add a backslash (\), scan **5, C, 5, C**.

Note: To add a backslash (\) as in Step 7, you must scan 5C twice – once to create the leading backslash and then to create the backslash itself.

- Step 8.** Scan **Save** to exit and save, or scan **Discard** to exit without saving. Repeat Steps 1-6 to add a prefix or suffix for another symbology.

Example: Add a Suffix to a specific symbology

To send a CR (carriage return) Suffix for U.P.C. only:

- Step 1.** Scan **Add Suffix**.
- Step 2.** Determine the 2 digit hex value from the Symbology Chart (included in the [Symbology Chart](#), beginning on page A-1) for U.P.C.
- Step 3.** Scan **6, 3** from the [Programming Chart](#) inside the back cover of this manual.
- Step 4.** Determine the hex value from the [ASCII Conversion Chart \(Code Page 1252\)](#) on page A-4, for the CR (carriage return).
- Step 5.** Scan **0, D** from the [Programming Chart](#) inside the back cover of this manual.
- Step 6.** Scan **Save**, or scan **Discard** to exit without saving.

To Clear One or All Prefixes or Suffixes

You can clear a single prefix or suffix, or clear all prefixes/suffixes for a symbology. If you have been entering prefixes and suffixes for single symbologies, you can use **Clear One Prefix (Suffix)** to delete a specific character from a symbology. When you **Clear All Prefixes (Suffixes)**, all the prefixes or suffixes for a symbology are deleted.

-
- Step 1.** Scan the **Clear One Prefix** or **Clear One Suffix** symbol.
 - Step 2.** Determine the 2 digit Hex value from the Symbology Chart (included in the [Symbology Chart](#), beginning on page A-1) for the symbology from which you want to clear the prefix or suffix.
 - Step 3.** Scan the 2 digit hex value from the [Programming Chart](#) inside the back cover of this manual or scan **9, 9** for all symbologies.

Your change is automatically saved.

To Add a Carriage Return Suffix to All Symbologies

Scan the following bar code if you wish to add a carriage return suffix to all symbologies at once. This action first clears all current suffixes, then programs a carriage return suffix for all symbologies.



VSUFCR.
**Add CR Suffix
All Symbologies**

Prefix Selections



PREBK2.
Add Prefix



PRECL2.
Clear One Prefix



PRECA2.
Clear All Prefixes

Suffix Selections



SUFBK2.
Add Suffix



SUFCL2.
Clear One Suffix



SUFCA2.
Clear All Suffixes

Transmit Alternate Extended ASCII Characters

You may need to emulate special keyboard functions, such as up or down arrows, Alt/Make or Alt/Break commands, that are not supported in the Extended ASCII Character table. Refer to [Alternate Extended ASCII Characters](#) (page 5-5) for a range of keyboard function keys and corresponding decimal and hex characters. If you scan the **Transmit Alternate Extended ASCII** code, any hex entries in a prefix or suffix will result in the corresponding Keyboard Function output.

Example: **Transmit Alternate Extended ASCII** is enabled, and you scan **Add Suffix**, then scan **9 9 8 9**. All symbologies (99) would have a suffix of a Page Down (hex 89) added to them.

When **Transmit Normal Extended ASCII** is selected, the normal extended ASCII character is transmitted (see [ASCII Conversion Chart \(Code Page 1252\)](#) on page A-4).

Example: **Transmit Normal Extended ASCII** is enabled, and you scan **Add Suffix**, then scan **9 9 8 9**. All symbologies (99) would have a suffix of a % character added to them.

Default = Transmit Alternate Extended ASCII.



KBDEXT0.

* **Transmit Alternate Extended ASCII**



KBDEXT1.

Transmit Normal Extended ASCII

Alternate Extended ASCII Characters					
DEC	HEX	Keyboard Function	DEC	HEX	Keyboard Function
128	80	up arrow ↑	152	98	F9
129	81	down arrow ↓	153	99	F10
130	82	right arrow →	154	9A	F11
131	83	left arrow ←	155	9B	F12
132	84	Insert	156	9C	Numeric Keypad +
133	85	Delete	157	9D	Numeric Keypad -
134	86	Home	158	9E	Numeric Keypad *
135	87	End	159	9F	Caps Lock
136	88	Page Up	160	A0	Num Lock
137	89	Page Down	161	A1	Left Alt
138	8A	Right ALT	162	A2	Left Ctrl
139	8B	Right CTRL	163	A3	Left Shift
140	8C	Reserved	164	A4	Right Shift
141	8D	Reserved	165	A5	Print Screen
142	8E	Numeric Keypad Enter	166	A6	Tab
143	8F	Numeric Keypad /	167	A7	Shift Tab
144	90	F1	168	A8	Enter
145	91	F2	169	A9	Esc
146	92	F3	170	AA	Alt Make
147	93	F4	171	AB	Alt Break
148	94	F5	172	AC	Control Make
149	95	F6	173	AD	Control Break
150	96	F7	174	AE	Alt Sequence with 1 Character
151	97	F8	175	AF	Ctrl Sequence with 1 Character

Function Code Transmit

When this selection is enabled and function codes are contained within the scanned data, the scanner transmits the function code to the terminal. Charts of these function codes are provided in [Supported Interface Keys](#) starting on [page 8-2](#). When the scanner is in keyboard wedge mode, the scan code is converted to a key code before it is transmitted. *Default = Enable.*



RMVFNC0.

* Enable



RMVFNC1.

Disable

Communication Check Character

To enhance security, you can specify the transmission type of a check character; either LRC where the calculation starts on the first transmitted character, LRC where the calculation starts on the second transmitted character, or CRC.

Note: This option adds a check character to the bar code data for all symbologies. If you need to enable or disable check characters for individual symbologies, see [Symbologies](#) beginning on page 7-1.

Scan the following bar code to set the communication check character type.
Default = None.



HSTXRC0.

* None



HSTXRC1.

LRC Starts on 1st Character



HSTXRC2.

LRC Starts on 2nd Character



HSTXRC3.

CRC

Intercharacter, Interfunction, and Intermassage Delays

Some terminals drop information (characters) if data comes through too quickly. Intercharacter, interfunction, and intermessage delays slow the transmission of data, increasing data integrity.

Intercharacter Delay

An intercharacter delay of up to 5000 milliseconds (in 5ms increments) may be placed between the transmission of each character of scanned data. Scan the following **Intercharacter Delay** bar code, then scan the number of 5ms delays, and the **Save** bar code using the **Programming Chart** inside the back cover of this manual.

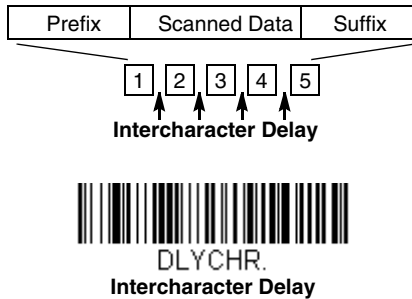

To remove this delay, scan the **Intercharacter Delay** bar code, then set the number of delays to 0. Scan the **Save** bar code using the **Programming Chart** inside the back cover of this manual.

Note: Intercharacter delays are not supported in USB serial emulation.

User Specified Intercharacter Delay

An intercharacter delay of up to 5000 milliseconds (in 5ms increments) may be placed after the transmission of a particular character of scanned data. Scan the following **Delay Length** bar code, then scan the number of 5ms delays, and the **Save** bar code using the **Programming Chart** inside the back cover of this manual.

Next, scan the **Character to Trigger Delay** bar code, then the 2-digit hex value for the ASCII character that will trigger the delay [ASCII Conversion Chart \(Code Page 1252\)](#) on page A-4.



DLYCRX.
Delay Length



DLY_XX.
Character to Trigger Delay

To remove this delay, scan the **Delay Length** bar code, and set the number of delays to 0. Scan the **Save** bar code using the [Programming Chart](#) inside the back cover of this manual.

Interfunction Delay

An interfunction delay of up to 5000 milliseconds (in 5ms increments) may be placed between the transmission of each segment of the message string. Scan the following **Interfunction Delay** bar code, then scan the number of 5ms delays, and the **Save** bar code using the [Programming Chart](#) inside the back cover of this manual.

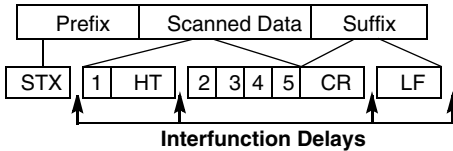

DLYFNC.
Interfunction Delay

To remove this delay, scan the **Interfunction Delay** bar code, then set the number of delays to 0. Scan the **Save** bar code using the [Programming Chart](#) inside the back cover of this manual.

Intermessage Delay

An intermessage delay of up to 5000 milliseconds (in 5ms increments) may be placed between each scan transmission. Scan the following **Intermessage Delay** bar code, then scan the number of 5ms delays, and the **Save** bar code using the [Programming Chart](#) inside the back cover of this manual.

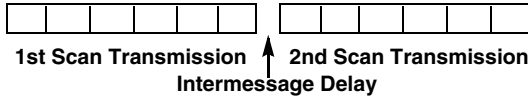

DLYMSG.

Intermessage Delay

To remove this delay, scan the **Intermessage Delay** bar code, then set the number of delays to 0. Scan the **Save** bar code using the [Programming Chart](#) inside the back cover of this manual.



Data Format Editor Introduction

You may use the Data Format Editor to change the scanner's output. For example, you can use the Data Format Editor to insert characters at certain points in bar code data as it is scanned. The selections in the following pages are used only if you wish to alter the output. *Default Data Format setting = None.*

Normally, when you scan a bar code, it gets outputted automatically; however when you create a format, you must use a "send" command (see [Send Commands](#) on page 6-4) within the format program to output data.

Multiple formats may be programmed into the scanner. They are stacked in the order in which they are entered. However, the following list presents the order in which formats are applied:

1. Specific Terminal ID, Actual Code ID, Actual Length
2. Specific Terminal ID, Actual Code ID, Universal Length
3. Specific Terminal ID, Universal Code ID, Actual Length
4. Specific Terminal ID, Universal Code ID, Universal Length
5. Universal Terminal ID, Actual Code ID, Actual Length
6. Universal Terminal ID, Actual Code ID, Universal Length
7. Universal Terminal ID, Universal Code ID, Actual Length
8. Universal Terminal ID, Universal Code ID, Universal Length

The maximum size of a data format configuration is 256 bytes, which includes header information. No format can contain more than 50 bytes.

If you have changed data format settings, and wish to clear all formats and return to the factory defaults, scan the following **Default Data Format** code.



DFMDF3.

* Default Data Format

To Add a Data Format

Step 1. Scan the **Enter Data Format** symbol ([page 6-2](#)).

Step 2. Select **Primary/Alternate Format**

Determine if this will be your primary data format, or one of 3 alternate formats. This allows you to save a total of 4 different data formats. To program your primary format, scan **0** using the [Programming Chart](#) inside the back cover of this manual. If you are programming an alternate format, scan **1**, **2**, or **3**, depending on which alternate format

you are programming. (See [Primary/Alternate Data Formats](#) on page 6-10 for further information.)

Step 3. Terminal Type

Refer to [Terminal ID Table](#) (page 6-4) and locate the Terminal ID number for your PC. Scan three numeric bar codes on the [Programming Chart](#) to program the scanner for your terminal ID (you must enter 3 digits). For example, scan **0 0 3** for an AT wedge.

Note: The wildcard for all terminal types is 099.

Step 4. Code I.D.

In the [Symbology Chart](#), beginning on page A-1, find the symbology to which you want to apply the data format. Locate the Hex value for that symbology and scan the 2 digit hex value from the [Programming Chart](#) inside the back cover of this manual.

Step 5. Length

Specify what length (up to 9999 characters) of data will be acceptable for this symbology. Scan the four digit data length from the [Programming Chart](#) inside the back cover of this manual. (Note: 50 characters is entered as 0050. 9999 is a universal number, indicating all lengths.)

Step 6. Editor Commands

Refer to (page 6-4). Scan the symbols that represent the command you want to enter. 94 alphanumeric characters may be entered for each symbology data format.

Step 7. Scan **Save** to save your data format, or **Discard** to exit without saving your changes.



MNUSAV.

Save



DFMBK3.

Enter Data Format



MNUABT.

Discard

Other Programming Selections

Clear One Data Format

This deletes one data format for one symbology. If you are clearing the primary format, scan **0** from the [Programming Chart](#) inside the back cover of this manual. If you are clearing an alternate format, scan **1**, **2**, or **3**, depending on the format you are clearing. Scan the Terminal Type and Code I.D. (see [Symbology Chart](#) on page A-1), and the bar code data length for the specific data format that you want to delete. All other formats remain unaffected.

Clear all Data Formats

This clears all data formats.

Save to exit and save your data format changes.

Discard to exit without saving any data format changes.



DFMCL3.

Clear One Data Format



DFMCA3.

Clear All Data Formats



MNUSAV.

Save



MNUABT.

Discard

Terminal ID Table

<u>Terminal</u>	<u>Model(s)</u>	<u>Terminal ID</u>
IBM	PC/AT and compatibles	003
	PS2 Keyboard	002
	USB SurePOS Handheld Scanner	128
	USB SurePOS Tabletop Scanner	129
RS232	True	000
	TTL	000
RS485		051
USB	Serial	130
	PC Keyboard	124
	Mac Keyboard	125
	Japanese Keyboard (PC)	134
	HID POS	131

Data Format Editor Commands

Send Commands

Send all characters

- F1 Include in the output message all of the characters from the input message, starting from current cursor position, followed by an insert character. *Syntax = F1xx* where xx stands for the insert character's hex value for its ASCII code.
Refer to the [ASCII Conversion Chart \(Code Page 1252\)](#) on page A-4 for decimal, hex and character codes.

Send a number of characters

- F2 Include in the output message a number of characters followed by an insert character. Start from the current cursor position and continue for "nn" characters or through the last character in the input message, followed by character "xx." *Syntax = F2nnxx* where nn stands for the numeric value (00-99) for the number of characters, and xx stands for the insert character's hex value for its ASCII code.
Refer to the [ASCII Conversion Chart \(Code Page 1252\)](#) on page A-4 for decimal, hex and character codes.

Send all characters up to a particular character

- F3 Include in the output message all characters from the input message, starting with the character at the current cursor position and continuing to, but not including, the search character “ss,” followed by an insert character. The cursor is moved forward to the “ss” character. *Syntax = F3ssxx* where ss stands for the search character’s hex value for its ASCII code, and xx stands for the insert character’s hex value for its ASCII code.
Refer to the [ASCII Conversion Chart \(Code Page 1252\)](#) on page A-4 for decimal, hex and character codes.

Send all but the last characters

- E9 Include in the output message all but the last “nn” characters, starting from the current cursor position. The cursor is moved forward to one position past the last input message character included. *Syntax = E9nn* where nn stands for the numeric value (00-99) for the number of characters that will not be sent at the end of the message.

Insert a character multiple times

- F4 Send “xx” character “nn” times in the output message, leaving the cursor in the current position. *Syntax = F4xxnn* where xx stands for the insert character’s hex value for its ASCII code, and nn is the numeric value (00-99) for the number of times it should be sent.
Refer to the [ASCII Conversion Chart \(Code Page 1252\)](#) on page A-4 for decimal, hex and character codes.

Insert symbology name

- B3 Insert the name of the bar code’s symbology in the output message, without moving the cursor. Only symbologies with a Honeywell ID are included (see [Symbology Chart](#) on page A-1).
Refer to the [ASCII Conversion Chart \(Code Page 1252\)](#) on page A-4 for decimal, hex and character codes.

Insert bar code length

- B4 Insert the bar code’s length in the output message, without moving the cursor. The length is expressed as a numeric string and does not include leading zeroes.

Move Commands

Move the cursor forward a number of characters

- F5 Move the cursor ahead “nn” characters from current cursor position. *Syntax = F5nn* where nn is the numeric value (00-99) for the number of characters the cursor should be moved ahead.

Move the cursor backward a number of characters

- F6 Move the cursor back “nn” characters from current cursor position. *Syntax = F6nn* where nn is the numeric value (00-99) for the number of characters the cursor should be moved back.

Move the cursor to the beginning

- F7 Move the cursor to the first character in the input message. *Syntax = F7.*

Move the cursor to the end

- EA Move the cursor to the last character in the input message. *Syntax = EA.*

Search Commands

Search forward for a character

- F8 Search the input message forward for “xx” character from the current cursor position, leaving the cursor pointing to the “xx” character. *Syntax = F8xx* where xx stands for the search character’s hex value for its ASCII code.
Refer to the [ASCII Conversion Chart \(Code Page 1252\)](#) on page A-4 for decimal, hex and character codes.

Search backward for a character

- F9 Search the input message backward for “xx” character from the current cursor position, leaving the cursor pointing to the “xx” character. *Syntax = F9xx* where xx stands for the search character’s hex value for its ASCII code.
Refer to the [ASCII Conversion Chart \(Code Page 1252\)](#) on page A-4 for decimal, hex and character codes.

Search forward for a string

- B0 Search forward for “s” string from the current cursor position, leaving cursor pointing to “s” string. *Syntax = B0nnnnS* where nnnn is the string length (up to 9999), and S consists of the ASCII hex value of each character in the match string. For example, B0000454657374 will search forward for the first occurrence of the 4 character string “Test.”
Refer to the [ASCII Conversion Chart \(Code Page 1252\)](#) on page A-4 for decimal, hex and character codes.

Search backward for a string

- B1 Search backward for “s” string from the current cursor position, leaving cursor pointing to “s” string. *Syntax = B1nnnnS* where nnnn is the string length (up to 9999), and S consists of the ASCII hex value of each character in the match string. For example, B1000454657374 will search backward for the first occurrence of the 4 character string “Test.”
Refer to the [ASCII Conversion Chart \(Code Page 1252\)](#) on page A-4 for decimal, hex and character codes.

Search forward for a non-matching character

- E6 Search the input message forward for the first non-“xx” character from the current cursor position, leaving the cursor pointing to the non-“xx” character. *Syntax = E6xx* where xx stands for the search character’s hex value for its ASCII code.
Refer to the [ASCII Conversion Chart \(Code Page 1252\)](#) on page A-4 for decimal, hex and character codes.

Search backward for a non-matching character

- E7 Search the input message backward for the first non-“xx” character from the current cursor position, leaving the cursor pointing to the non-“xx” character. *Syntax = E7xx* where xx stands for the search character’s hex value for its ASCII code.
Refer to the [ASCII Conversion Chart \(Code Page 1252\)](#) on page A-4 for decimal, hex and character codes.

Miscellaneous Commands

Suppress characters

- FB Suppress all occurrences of up to 15 different characters, starting at the current cursor position, as the cursor is advanced by other commands. When the FC command is encountered, the suppress function is terminated. The cursor is not moved by the FB command.
Syntax = FBnnxxyy . .zz where nn is a count of the number of suppressed characters in the list, and xxyy ..zz is the list of characters to be suppressed.

Stop suppressing characters

- FC Disables suppress filter and clear all suppressed characters. *Syntax = FC.*

Replace characters

- E4 Replaces up to 15 characters in the output message, without moving the cursor. Replacement continues until the E5 command is encountered. *Syntax = E4nnxx₁xx₂yy₁yy₂...zz₁zz₂* where nn is the total count of the number of characters in the list (characters to be replaced plus replacement characters); xx₁ defines characters to be replaced and xx₂ defines replacement characters, continuing through zz₁ and zz₂.

Stop replacing characters

- E5 Terminates character replacement. *Syntax = E5.*

Compare characters

- FE Compare the character in the current cursor position to the character “xx.” If characters are equal, move the cursor forward one position. *Syntax = FExx* where xx stands for the comparison character’s hex value for its ASCII code. Refer to the [ASCII Conversion Chart \(Code Page 1252\)](#) on page A-4 for decimal, hex and character codes.

Compare string

- B2 Compare the string in the input message to the string “s.” If the strings are equal, move the cursor forward past the end of the string. *Syntax = B2nnnnS* where nnnn is the string length (up to 9999), and S consists of the ASCII hex value of each character in the match string. For example, B2000454657374 will compare the string at the current cursor position with the 4 character string “Test.” Refer to the [ASCII Conversion Chart \(Code Page 1252\)](#) on page A-4 for decimal, hex and character codes.

Check for a number

- EC Check to make sure there is an ASCII number at the current cursor position. The format is aborted if the character is not numeric.

Check for non-numeric character

- ED Check to make sure there is a non-numeric ASCII character at the current cursor position. The format is aborted if the character is numeric.

Insert a delay

- EF Inserts a delay of up to 49,995 milliseconds (in multiples of 5), starting from the current cursor position. *Syntax = EFnnnn* where nnnn stands for the delay in 5ms increments, up to 9999. This command can only be used with keyboard wedge interfaces.

Data Formatter

When Data Formatter is turned Off, the bar code data is output to the host as read, including prefixes and suffixes.



DFM_END.
Data Formatter Off

You may wish to require the data to conform to a data format you have created and saved. The following settings can be applied to your data format:

Data Formatter On, Not Required, Keep Prefix/Suffix

Scanned data is modified according to your data format, and prefixes and suffixes are transmitted.

Data Formatter On, Not Required, Drop Prefix/Suffix

Scanned data is modified according to your data format. If a data format is found for a particular symbol, those prefixes and suffixes are not transmitted.

Data Format Required, Keep Prefix/Suffix

Scanned data is modified according to your data format, and prefixes and suffixes are transmitted. Any data that does not match your data format requirements generates an error tone and the data in that bar code is not transmitted. If you wish to process this type of bar code without generating an error tone, see [Data Format Non-Match Error Tone](#).

Data Format Required, Drop Prefix/Suffix

Scanned data is modified according to your data format. If a data format is found for a particular symbol, those prefixes and suffixes are not transmitted. Any data that does not match your data format requirements generates an error tone. If you wish to process this type of bar code without generating an error tone, see [Data Format Non-Match Error Tone](#).

Choose one of the following options. *Default = Data Formatter On, Not Required, Keep Prefix/Suffix.*



DFM_EN3.

**Data Formatter On,
Not Required,
Drop Prefix/Suffix**



DFM_EN4.

**Data Format Required,
Drop Prefix/Suffix**



DFM_EN1.

*** Data Formatter On,
Not Required,
Keep Prefix/Suffix**



DFM_EN2.

**Data Format Required,
Keep Prefix/Suffix**

Data Format Non-Match Error Tone

When a bar code is encountered that doesn't match your required data format, the scanner normally generates an error tone. However, you may want to continue scanning bar codes without hearing the error tone. If you scan the **Data Format Non-Match Error Tone Off** bar code, data that doesn't conform to your data format is not transmitted, and no error tone

will sound. If you wish to hear the error tone when a non-matching bar code is found, scan the **Data Format Non-Match Error Tone On** bar code. *Default = Data Format Non-Match Error Tone On.*



DFMDEC1.

**Data Format Non-Match
Error Tone Off**



DFMDEC0.

*** Data Format Non-Match Error
Tone On**

Primary/Alternate Data Formats

You can save up to four data formats, and switch between these formats. Your primary data format is saved under **0**. Your other three formats are saved under **1**, **2**, and **3**. To set your device to use one of these formats, scan one of the following bar codes.



ALTFNM0.

Primary Data Format



ALTFNM1.

Data Format 1



ALTFNM2.

Data Format 2



ALTFNM3.

Data Format 3

Single Scan Data Format Change

You can also switch between data formats for a single scan. The next bar code is scanned using an alternate data format, then reverts to the format you have selected above (either Primary, 1, 2, or 3).

For example, you may have set your device to the data format you saved as Data Format 3. You can switch to Data Format 1 for a single button press by scanning the following **Single Scan-Data Format 1** bar code. The next bar code that is scanned uses Data Format 1, then reverts back to Data Format 3.



VSAF_1.

Single Scan-Data Format 1



VSAF_3.

Single Scan-Data Format 3



VSAF_0.

**Single Scan-Primary
Data Format**



VSAF_2.

Single Scan-Data Format 2



Symbologies

This programming section contains the following menu selections. Refer to [Chapter 10](#) for settings and defaults.

- All Symbologies
- Airline Code 5 - see Straight 2 of 5 IATA (two-bar start/stop)
- China Post (Hong Kong 2 of 5)
- Codabar
- Code 11
- Code 128
- Code 32 Pharmaceutical (PARAF)
- Code 39
- Code 93
- EAN/JAN-13
- EAN/JAN-8
- GS1 DataBar Expanded
- GS1 DataBar Limited
- GS1 DataBar Omnidirectional
- GS1 Emulation
- GS1-128
- Interleaved 2 of 5
- ISBT 128
- Matrix 2 of 5
- MSI
- NEC 2 of 5
- Plessey Code
- Postal Codes
- Straight 2 of 5 IATA (two-bar start/stop)
- Straight 2 of 5 Industrial (three-bar start/stop)
- Telepen
- Trioptic Code
- UPC-A
- UPC-A/EAN-13 with Extended Coupon Code
- UPC-E0

All Symbologies

If you want to decode all the symbologies allowable for your scanner, scan the **All Symbologies On** code. If on the other hand, you want to decode only a particular symbology, scan **All Symbologies Off** followed by the On symbol for that particular symbology.



ALLEN.A1.

All Symbologies On



ALLEN.A0.

All Symbologies Off

Message Length Description

You are able to set the valid reading length of some of the bar code symbologies. If the data length of the scanned bar code doesn't match the valid reading length, the scanner will issue an error tone. You may wish to set the same value for minimum and maximum length to force the scanner to read fixed length bar code data. This helps reduce the chances of a misread.

EXAMPLE: Decode only those bar codes with a count of 9-20 characters.
Min. length = 09Max. length = 20

EXAMPLE: Decode only those bar codes with a count of 15 characters.
Min. length = 15Max. length = 15

For a value other than the minimum and maximum message length defaults, scan the bar codes included in the explanation of the symbology, then scan the digit value of the message length and **Save** bar codes on the [Programming Chart](#) inside the back cover of this manual. The minimum and maximum lengths and the defaults are included with the respective symbologies.

Codabar

<Default All Codabar Settings>



Codabar On/Off



Codabar Start/Stop Characters

Start/Stop characters identify the leading and trailing ends of the bar code. You may either transmit, or not transmit Start/Stop characters. *Default = Don't Transmit.*



Codabar Check Character

Codabar check characters are created using different “modulos.” You can program the scanner to read only Codabar bar codes with Modulo 16, Modulo 7 CD, or CLSI check characters. *Default = No Check Character.*

No Check Character indicates that the scanner reads and transmits bar code data with or without a check character.

When Check Character is set to **Validate and Transmit**, the scanner will only read Codabar bar codes printed with a check character, and will transmit this character at the end of the scanned data.

When Check Character is set to **Validate, but Don't Transmit**, the unit will only read Codabar bar codes printed **with** a check character, but will not transmit the check character with the scanned data.



CBRCK20.

* No Check Character



CBRCK22.

Validate Modulo 16
and Transmit



CBRCK24.

Validate Modulo 7 CD and
Transmit



CBRCK26.

Validate CLSI and Transmit



CBRCK21.

Validate Modulo 16, but
Don't Transmit



CBRCK23.

Validate Modulo 7 CD, but Don't
Transmit



CBRCK25.

Validate CLSI, but Don't
Transmit

Codabar Concatenation

Codabar supports symbol concatenation. When you enable concatenation, the scanner looks for a Codabar symbol having a "D" start character, adjacent to a symbol having a "D" stop character. In this case the two messages are concatenated into one with the "D" characters omitted.



A 1 2 3 4 D



D 5 6 7 8 A

Select Require to prevent the scanner from decoding a single “D” Codabar symbol without its companion. This selection has no effect on Codabar symbols without Stop/Start D characters.



CBRCT1.

On



CBRCT0.

* Off



CBRCT2.

Require

Concatenation Timeout

When searching for bar codes during concatenation, you may wish to set a delay used to find the next bar code. Set the length (in milliseconds) for this delay by scanning the following bar code, then setting the timeout (from 1-65535 milliseconds) by scanning digits from the [Programming Chart](#), then scanning [Save](#). *Default = 750.*



DLYCCT.

Concatenation Timeout

Codabar Redundancy

If you are encountering errors when reading Codabar bar codes, you may want to adjust the redundancy count. Redundancy adjusts the number of times a bar code is decoded before transmission, which may reduce the number of errors. Note that the higher the redundancy count, the longer it will take to decode the bar code. To adjust the redundancy, scan the following **Codabar Redundancy** bar code, then scan a redundancy count between 0 and 10 on the [Programming Chart](#) inside the back cover of this manual. Then scan the [Save](#) bar code. *Default = 0.*



CBRVOT.

Codabar Redundancy

Codabar Message Length

Scan the following bar codes to change the message length. Refer to [Message Length Description](#) (page 7-2) for additional information. Minimum and Maximum lengths = 1-80. Minimum Default = 3, Maximum Default = 80.



CBRMIN.

Minimum Message Length



CBRMAX.

Maximum Message Length

Code 39

< Default All Code 39 Settings >



C39DFT.

Code 39 On/Off



C39ENA1.

* On



C39ENAO.

Off

Code 39 Start/Stop Characters

Start/Stop characters identify the leading and trailing ends of the bar code. You may either transmit, or not transmit Start/Stop characters. *Default = Don't Transmit.*



C39SSX1.

Transmit



C39SSXD.

* Don't Transmit

Code 39 Check Character

No Check Character indicates that the scanner reads and transmits bar code data with or without a check character.

When Check Character is set to **Validate, but Don't Transmit**, the unit only reads Code 39 bar codes printed with a check character, but will not transmit the check character with the scanned data.

When Check Character is set to **Validate and Transmit**, the scanner only reads Code 39 bar codes printed with a check character, and will transmit this character at the end of the scanned data. *Default = No Check Character.*



C39CK20.

* No Check Character



C39CK21.

Validate, but Don't Transmit



C39CK22.

Validate and Transmit

Code 39 Redundancy

If you are encountering errors when reading Code 39 bar codes, you may want to adjust the redundancy count. Redundancy adjusts the number of times a bar code is decoded before transmission, which may reduce the number of errors. Note that the higher the redundancy count, the longer it will take to decode the bar code. To adjust the redundancy, scan the **Code 39 Redundancy** bar code below, then scan a redundancy count between 0 and 10 on the [Programming Chart](#) inside the back cover of this manual. Then scan the **Save** bar code. *Default = 0.*



C39VOT.

Code 39 Redundancy

Code 39 Message Length

Scan the bar codes below to change the message length. Refer to [Message Length Description](#) (page 7-2) for additional information. Minimum and Maximum lengths = 1-80. Minimum Default = 3, Maximum Default = 80.



C39MIN.

Minimum Message Length



C39MAX.

Maximum Message Length

Code 32 Pharmaceutical (PARAF)

Code 32 Pharmaceutical is a form of the Code 39 symbology used by Italian pharmacies. This symbology is also known as PARAF.



C39B321.

On



C39B320.

* Off

Full ASCII

If Full ASCII Code 39 decoding is enabled, certain character pairs within the bar code symbol will be interpreted as a single character. For example: \$V will be decoded as the ASCII character SYN, and /C will be decoded as the ASCII character #. *Default = Off.*

NUL %U	DLE \$P	SP	SPACE	0	0	@	%V	P	P	'	%W	p	+P
SOH \$A	DC1 \$Q	!	/A	1	1	A	A	Q	Q	a	+A	q	+Q
STX \$B	DC2 \$R	"	/B	2	2	B	B	R	R	b	+B	r	+R
ETX \$C	DC3 \$S	#	/C	3	3	C	C	S	S	c	+C	s	+S
EOT \$D	DC4 \$T	\$	/D	4	4	D	D	T	T	d	+D	t	+T
ENQ \$E	NAK \$U	%	/E	5	5	E	E	U	U	e	+E	u	+U
ACK \$F	SYN \$V	&	/F	6	6	F	F	V	V	f	+F	v	+V
BEL \$G	ETB \$W	'	/G	7	7	G	G	W	W	g	+G	w	+W
BS \$H	CAN \$X	(/H	8	8	H	H	X	X	h	+H	x	+X
HT \$I	EM \$Y)	/I	9	9	I	I	Y	Y	i	+I	y	+Y
LF \$J	SUB \$Z	*	/J	:	/Z	J	J	Z	Z	j	+J	z	+Z
VT \$K	ESC %A	+	/K	;	%F	K	K	[%K	k	+K	{	%P
FF \$L	FS %B	,	/L	<	%G	L	L	\	%L	l	+L		%Q
CR \$M	GS %C	-	-	=	%H	M	M]	%M	m	+M	}	%R
SO \$N	RS %D	.	.	>	%I	N	N	^	%N	n	+N	~	%S
SI \$O	US %E	/	/O	?	%J	O	O	_	%O	o	+O	DEL	%T

Character pairs /M and /N decode as a minus sign and period respectively.
Character pairs /P through /Y decode as 0 through 9.



C39ASC1.
Full ASCII On



C39ASC0.
* Full ASCII Off

Interleaved 2 of 5

< *Default All Interleaved 2 of 5 Settings* >



Interleaved 2 of 5 On/Off



Follett Formatting



NULL Characters

Interleaved 2 of 5 requires an even number of characters. When an odd number of characters is present, it is due to NULL characters embedded in the bar code. Scan the **On** bar code below to decode this type of Interleaved 2 of 5 bar code. *Default = Off.*



Check Digit

No Check Digit indicates that the scanner reads and transmits bar code data with or without a check digit.

When Check Digit is set to **Validate, but Don't Transmit**, the unit only reads Interleaved 2 of 5 bar codes printed with a check digit, but will not transmit the check digit with the scanned data.

When Check Digit is set to **Validate and Transmit**, the scanner only reads Interleaved 2 of 5 bar codes printed with a check digit, and will transmit this digit at the end of the scanned data. *Default = No Check Digit.*



125CK20.

* No Check Digit



125CK21.

Validate, but Don't Transmit



125CK22.

Validate and Transmit

Interleaved 2 of 5 Redundancy

If you are encountering errors when reading Interleaved 2 of 5 bar codes, you may want to adjust the redundancy count. Redundancy adjusts the number of times a bar code is decoded before transmission, which may reduce the number of errors. Note that the higher the redundancy count, the longer it will take to decode the bar code. To adjust the redundancy, scan the **Interleaved 2 of 5 Redundancy** bar code below, then scan a redundancy count between 0 and 10 on the [Programming Chart](#) inside the back cover of this manual. Then scan the **Save** bar code. *Default = 0.*



125VOT.

Interleaved 2 of 5 Redundancy

Interleaved 2 of 5 Message Length

Scan the bar codes below to change the message length. Refer to [Message Length Description](#) (page 7-2) for additional information. Minimum and Maximum lengths = 1-80. Minimum Default = 6, Maximum Default = 80.



I25MIN.

Minimum Message Length



I25MAX.

Maximum Message Length

NEC 2 of 5

< Default All NEC 2 of 5 Settings >



N25DFT.

NEC 2 of 5 On/Off



N25ENA1.

On



N25ENA0.

*** Off**

Check Digit

No Check Digit indicates that the scanner reads and transmits bar code data with or without a check digit.

When Check Digit is set to **Validate, but Don't Transmit**, the unit only reads NEC 2 of 5 bar codes printed with a check digit, but will not transmit the check digit with the scanned data.

When Check Digit is set to **Validate and Transmit**, the scanner only reads NEC 2 of 5 bar codes printed with a check digit, and will transmit this digit at the end of the scanned data. *Default = No Check Digit.*



N25CK20.

* No Check Digit



N25CK21.

Validate, but Don't Transmit



N25CK22.

Validate and Transmit

NEC 2 of 5 Redundancy

If you are encountering errors when reading NEC 2 of 5 bar codes, you may want to adjust the redundancy count. Redundancy adjusts the number of times a bar code is decoded before transmission, which may reduce the number of errors. Note that the higher the redundancy count, the longer it will take to decode the bar code. To adjust the redundancy, scan the **NEC 2 of 5 Redundancy** bar code below, then scan a redundancy count between 0 and 10 on the [Programming Chart](#) inside the back cover of this manual. Then scan the **Save** bar code. *Default = 0.*



N25VOT.

NEC 2 of 5 Redundancy

NEC 2 of 5 Message Length

Scan the bar codes below to change the message length. Refer to [Message Length Description](#) (page 7-2) for additional information. Minimum and Maximum lengths = 1-80. Minimum Default = 3, Maximum Default = 80.



N25MIN.

Minimum Message Length



N25MAX.

Maximum Message Length

Code 93

< Default All Code 93 Settings >



C93DFT.

Code 93 On/Off



C93ENA1.

* On



C93ENAD.

Off

Code 93 Redundancy

If you are encountering errors when reading Code 93 bar codes, you may want to adjust the redundancy count. Redundancy adjusts the number of times a bar code is decoded before transmission, which may reduce the number of errors. Note that the higher the redundancy count, the longer it will take to decode the bar code. To adjust the redundancy, scan the **Code 93 Redundancy** bar code below, then scan a redundancy count between 0 and 10 on the [Programming Chart](#) inside the back cover of this manual. Then scan the **Save** bar code. *Default = 0.*



C93VOT.

Code 93 Redundancy

Code 93 Message Length

Scan the bar codes below to change the message length. Refer to [Message Length Description](#) (page 7-2) for additional information. Minimum and Maximum lengths = 1-80. Minimum Default = 3, Maximum Default = 80.



C93MIN.

Minimum Message Length



C93MAX.

Maximum Message Length

Straight 2 of 5 Industrial (three-bar start/stop)

<Default All Straight 2 of 5 Industrial Settings>



R25DFT.

Straight 2 of 5 Industrial On/Off



R25ENA1.

On



R25ENA0.

* Off

Straight 2 of 5 Industrial Redundancy

If you are encountering errors when reading Straight 2 of 5 Industrial bar codes, you may want to adjust the redundancy count. Redundancy adjusts the number of times a bar code is decoded before transmission, which may reduce the number of errors. Note that the higher the redundancy count, the longer it will take to decode the bar code. To adjust the redundancy, scan the **Straight 2 of 5 Industrial Redundancy** bar code below, then

scan a redundancy count between 0 and 10 on the [Programming Chart](#) inside the back cover of this manual. Then scan the **Save** bar code.
Default = 0.



R25VOT.

**Straight 2 of 5 Industrial
Redundancy**

Straight 2 of 5 Industrial Message Length

Scan the bar codes below to change the message length. Refer to [Message Length Description](#) (page 7-2) for additional information. Minimum and Maximum lengths = 1-80. Minimum Default = 3, Maximum Default = 80.



R25MIN.

Minimum Message Length



R25MAX.

Maximum Message Length

Straight 2 of 5 IATA (two-bar start/stop)

Note: This symbology is also known as Airline Code 5.

<Default All Straight 2 of 5 IATA Settings>



Straight 2 of 5 IATA On/Off



Straight 2 of 5 IATA Redundancy

If you are encountering errors when reading Straight 2 of 5 IATA bar codes, you may want to adjust the redundancy count. Redundancy adjusts the number of times a bar code is decoded before transmission, which may reduce the number of errors. Note that the higher the redundancy count, the longer it will take to decode the bar code. To adjust the redundancy, scan the **Straight 2 of 5 IATA Redundancy** bar code below, then scan a redundancy count between 0 and 10 on the [Programming Chart](#) inside the back cover of this manual. Then scan the **Save** bar code. *Default = 0.*



Straight 2 of 5 IATA Message Length

Scan the bar codes below to change the message length. Refer to [Message Length Description](#) (page 7-2) for additional information. Minimum and Maximum lengths = 1-80. Minimum Default = 13, Maximum Default = 15.



A25MIN.

Minimum Message Length



A25MAX.

Maximum Message Length

Matrix 2 of 5

<Default All Matrix 2 of 5 Settings>



X25DFT.

Matrix 2 of 5 On/Off



X25ENA1.

On



X25ENA0.

*** Off**

Matrix 2 of 5 Check Character

No Check Character indicates that the scanner reads and transmits bar code data with or without a check character.

When Check Character is set to **Validate, but Don't Transmit**, the unit only reads Matrix 2 of 5 bar codes printed with a check character, but will not transmit the check character with the scanned data.

When Check Character is set to **Validate and Transmit**, the scanner only reads Matrix 2 of 5 bar codes printed with a check character, and will transmit this character at the end of the scanned data. *Default = No Check Character.*



X25CK20.

* No Check Character



X25CK21.

Validate, but Don't Transmit



X25CK22.

Validate and Transmit

Matrix 2 of 5 Redundancy

If you are encountering errors when reading Matrix 2 of 5 bar codes, you may want to adjust the redundancy count. Redundancy adjusts the number of times a bar code is decoded before transmission, which may reduce the number of errors. Note that the higher the redundancy count, the longer it will take to decode the bar code. To adjust the redundancy, scan the **Matrix 2 of 5 Redundancy** bar code below, then scan a redundancy count between 0 and 10 on the [Programming Chart](#) inside the back cover of this manual. Then scan the **Save** bar code. *Default = 0.*



X25VOT.

Matrix 2 of 5 Redundancy

Matrix 2 of 5 Message Length

Scan the bar codes below to change the message length. Refer to [Message Length Description](#) (page 7-2) for additional information. Minimum and Maximum lengths = 1-80. Minimum Default = 3, Maximum Default = 80.



X25MIN.

Minimum Message Length



X25MAX.

Maximum Message Length

Code 11

<Default All Code 11 Settings>



C11DFT.

Code 11 On/Off



C11ENA1.

On



C11ENAD.

* Off

Check Digits Required

These options set whether 1 or 2 check digits are required with Code 11 bar codes. **Auto Select Check Digits** determines the number of check digits based on the length of the bar code. If the bar code is 10 digits or more, 2 check digits are required. If it is 9 digits or less, 1 check digit is required. The check digit data is only transmitted if you program that feature (see [Check Digit Validation](#) on page 7-22). *Default = Two Check Digits Required.*



C11CK20.

One Check Digit Required



C11CK21.

* Two Check Digits Required



C11CK22.

Auto Select Check Digits
Required

Check Digit Validation

When Check Character is set to **Validate and Transmit**, the scanner will only read Code 11 bar codes printed with the specified type check character(s), and will transmit the character(s) at the end of the scanned data.



C11CK23.

**Validate and Transmit One
Check Digit**



C11CK24.

**Validate and Transmit Two
Check Digits**



C11CK25.

**Validate and Transmit Auto
Select Check Digits**

Code 11 Redundancy

If you are encountering errors when reading Code 11 bar codes, you may want to adjust the redundancy count. Redundancy adjusts the number of times a bar code is decoded before transmission, which may reduce the number of errors. Note that the higher the redundancy count, the longer it will take to decode the bar code. To adjust the redundancy, scan the **Code 11 Redundancy** bar code below, then scan a redundancy count between 0 and 10 on the [Programming Chart](#) inside the back cover of this manual. Then scan the **Save** bar code. *Default = 0.*



C11VOT.

Code 11 Redundancy

Code 11 Message Length

Scan the bar codes below to change the message length. Refer to [Message Length Description](#) (page 7-2) for additional information. Minimum and Maximum lengths = 1-80. Minimum Default = 3, Maximum Default = 80.



C11MIN.

Minimum Message Length



C11MAX.

Maximum Message Length

Code 128

<Default All Code 128 Settings>



128DFT.

Code 128 On/Off



128ENA1.

* On



128ENA0.

Off

128 Group Separator Output

If you wish to transmit the group separator characters “GS” (0x1D hex) with your Code 128 bar code output, scan the **On** bar code. When **Off** is scanned, the group separator is not output. *Default =Off.*



128GSE1.

On



128GSE0.

* Off

Code 128 Redundancy

If you are encountering errors when reading Code 128 bar codes, you may want to adjust the redundancy count. Redundancy adjusts the number of times a bar code is decoded before transmission, which may reduce the number of errors. Note that the higher the redundancy count, the longer it will take to decode the bar code. To adjust the redundancy, scan the **Code**

128 Redundancy bar code below, then scan a redundancy count between 0 and 10 on the [Programming Chart](#) inside the back cover of this manual. Then scan the **Save** bar code. *Default = 0.*



128VOT.

Code 128 Redundancy

Code 128 Message Length

Scan the bar codes below to change the message length. Refer to [Message Length Description](#) (page 7-2) for additional information. Minimum and Maximum lengths = 1-80. Minimum Default = 3, Maximum Default = 80.



128MIN.

Minimum Message Length



128MAX.

Maximum Message Length

ISBT 128

ISBT is a variation of Code 128 that supports concatenation of neighboring symbols on a blood product label. Use the bar codes below to turn ISBT 128 concatenation on or off. *Default =Off.*



ISBENA1.

On



ISBENA0.

*** Off**

Concatenation Timeout

When searching for bar codes during concatenation, you may wish to set a delay used to find the next bar code. Set the length (in milliseconds) for this delay by scanning the bar code below, then setting the timeout (from 1-65535 milliseconds) by scanning digits from the [Programming Chart](#), then scanning **Save**. *Default = 750.*



DLYCCT.

Concatenation Timeout

ISBT 128 Predefined Concatenation Sequences

Note: You must enable Code 128 and ISBT 128 to use this feature.

The following bar codes are used to select the pre-defined ISBT 128 Concatenation Sequence you wish to use. Once you have selected the concatenation sequence, use [ISBT 128 Predefined Concatenation Sequences On/Off](#) to enable this feature. *Default = Donation ID Number (001) and ABO/RhD Blood Groups (002).*



ISBPCS0.

* Donation ID Number (001)
and ABO/RhD Blood Groups (002)



ISBPCS2.

Donation ID Number (001) and
Confidential Unit Exclusion
Status



ISBPCS4.

Product Code (003) and
Expiration Date (Form 2)



ISBPCS6.

Product Code (003) and
Expiration Date (Form 4)



ISBPCS1.

Donation ID Number (001) and
Donor ID Number (019)

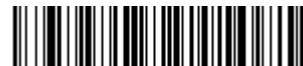

ISBPCS3.

Product Code (003) and
Expiration Date (Form 1)



ISBPCS5.

Product Code (003) and
Expiration Date (Form 3)

ISBT 128 Predefined Concatenation Sequences On/Off

The following selections allow you to enable or require the Predefined ISBT 128 Concatenation Sequences.

If you scan **Off**, the predefined concatenation sequences are disabled.

If you scan the **Allow Predefined Sequence** code, then the scanner will output only the data combination specified in the predefined concatenation sequence you selected.

If you scan the **Require Predefined Sequence** code, the data combination specified in the predefined concatenation sequence you selected is required to transmit the data. No data is output unless the sequence is read.

Default = Off.



ISBT 128 User-Defined Concatenation Sequences

Note: You must enable Code 128 and ISBT 128 to use this feature.

The following bar codes are used to create a custom ISBT 128 Concatenation Sequence. Select the identifiers you want to transmit in the 1st and 2nd positions, both left and right. Refer to the ISBT 128 Standard Technical Specification for the list of data identifiers.

Use the [ASCII Conversion Chart \(Code Page 1252\)](#), beginning on page A-4, to find the characters needed for the identifier. Locate the hex value for each character and scan that 2 digit/character value from the [Programming Chart](#) inside the back cover of this manual.

Example: You want to create a concatenation sequence that has the Donation Identification Number (001) as the left identifier, and Product Code (003) as the right identifier.

The ISBT Index of Data Structures shows that for the Donation Identification Number, the first character is “=” and the second character can be from A-N; P-Z; 1-9. For this example, use “G.” The Product Code first character is “=” and the second character is “<.”

-
- Step 1.** Scan the **1st Left Identifier** bar code, below.
 - Step 2.** Use the [Programming Chart](#) to scan **3, D** (hex for “=”).
 - Step 3.** Scan **Save**.
 - Step 4.** Scan the **2nd Left Identifier** bar code, below.
 - Step 5.** Use the [Programming Chart](#) to scan **4, 7** (hex for “G”).
 - Step 6.** Scan **Save**.
 - Step 7.** Scan the **1st Right Identifier** bar code, below.
 - Step 8.** Use the [Programming Chart](#) to scan **3, D** (hex for “=”).
 - Step 9.** Scan **Save**.
 - Step 10.** Scan the **2nd Right Identifier** bar code, below.
 - Step 11.** Use the [Programming Chart](#) to scan **3, C** (hex for “<”).
 - Step 12.** Scan **Save**.

Once you have programmed the concatenation sequence, use [ISBT 128 User-Defined Concatenation Sequences](#) to enable this feature. *Default = 0.*



ISBUL1.
1st Left Identifier



ISBUL2.
2nd Left Identifier



ISBUR1.
1st Right Identifier



ISBUR2.
2nd Right Identifier

ISBT 128 User-Defined Concatenation Sequences On/Off

The following selections allow you to enable or require the User-Defined ISBT 128 Concatenation Sequences.

If you scan **Off**, the User-Defined concatenation sequences are disabled.

If you scan the **Allow User-Defined Sequence** code, then the scanner will output only the data combination specified in the User-Defined concatenation sequence you created.

If you scan the **Require User-Defined Sequence** code, the data combination specified in the User-Defined concatenation sequence is required to transmit the data. No data is output unless the sequence is read.

Default = Off.



ISBUCE0.
* **Off**



ISBUCE1.
Allow User-Defined Sequence



ISBUCE2.
Require User-Defined Sequence

Content Verification

When the **On** bar code is scanned, the check character values are output along with the bar code data, thus allowing you to verify that the check character is in agreement with that calculated for the data stream. *Default = Off.*



ISBXM01.
On



ISBXM00.
* **Off**

Transmit Identifiers

You may disable the transmission of the ISBT Code 128 data identifiers by scanning **Off**. When this selection is **Off**, the first 2 data (ID) characters are removed from the data stream unless the ISBT code contains the Donation Identification Number identifiers. If the code contains the Donation Identifi-

cation Number identifiers, only the first ID character is removed from the Donation Identification Number. The second character is transmitted as normal data. *Default = On.*



ISBXM11.

* On



ISBXM10.

Off

Flag Digit Conversion

Type 3 flag digits are a part of the Donation Identification Number in an ISBT 128 bar code. If you select **On**, the flag data is converted into a single MOD (37, 2) character and transmitted with the bar code data. Scan **Off** if you do not want the flag digits transmitted. *Default = Off.*



ISBXM21.

On



ISBXM20.

* Off

GS1-128

<Default All GS1-128 Settings>



GS1-128 On/Off



GS1-128 Application Identifier Parsing

This allows a single GS1-128 bar code to be broken into multiple transmissions based on the presence of application identifiers (AI) embedded in the bar code. Scan **Transmit Without Identifiers** if you want the bar code broken into packets and stripped of the AI. If you want the AI included, scan **Transmit With Identifiers**. *Default = Off.*



GS1-128 Redundancy

If you are encountering errors when reading GS1-128 bar codes, you may want to adjust the redundancy count. Redundancy adjusts the number of times a bar code is decoded before transmission, which may reduce the number of errors. Note that the higher the redundancy count, the longer it will take to decode the bar code. To adjust the redundancy, scan the **GS1-**

128 Redundancy bar code below, then scan a redundancy count between 0 and 10 on the [Programming Chart](#) inside the back cover of this manual. Then scan the **Save** bar code. *Default = 0.*



GS1VOT.

GS1-128 Redundancy

GS1-128 Message Length

Scan the bar codes below to change the message length. Refer to [Message Length Description](#) (page 7-2) for additional information. Minimum and Maximum lengths = 1-80. Minimum Default = 3, Maximum Default = 80.



GS1MIN.

Minimum Message Length



GS1MAX.

Maximum Message Length

Telepen

<Default All Telepen Settings>



Telepen On/Off



Telepen Output

Using AIM Telepen Output, the scanner reads symbols with start/stop pattern 1 and decodes them as standard full ASCII (start/stop pattern 1). When Original Telepen Output is selected, the scanner reads symbols with start/stop pattern 1 and decodes them as compressed numeric with optional full ASCII (start/stop pattern 2). *Default = AIM Telepen Output.*



Telepen Redundancy

If you are encountering errors when reading Telepen bar codes, you may want to adjust the redundancy count. Redundancy adjusts the number of times a bar code is decoded before transmission, which may reduce the number of errors. Note that the higher the redundancy count, the longer it will take to decode the bar code. To adjust the redundancy, scan the

Telepen Redundancy bar code below, then scan a redundancy count between 0 and 10 on the [Programming Chart](#) inside the back cover of this manual. Then scan the **Save** bar code. *Default = 0.*



TELVOT.

Telepen Redundancy

Telepen Message Length

Scan the bar codes below to change the message length. Refer to [Message Length Description](#) (page 7-2) for additional information. Minimum and Maximum lengths = 1-80. Minimum Default = 3, Maximum Default = 80.



TELMIN.

Minimum Message Length



TELMAX.

Maximum Message Length

UPC-A

<Default All UPC-A Settings>



UPAEFT.

UPC-A On/Off



UPAENA1.

* On



UPAENA0.

Off

UPC-A Number System and Check Digit

UPC-A sample showing the number system and check digit:



UPC-A Number System

The numeric system digit of a U.P.C. symbol is normally transmitted at the beginning of the scanned data, but the can be programmed so it will not transmit it. *Default = On.*



UPANSX1.

* On



UPANSX0.

Off

UPC-A Check Digit

This selection allows you to specify whether the check digit should be transmitted at the end of the scanned data or not. *Default = On.*



UPACKX1.

* On



UPACKX0.

Off

UPC-A Addenda

This selection adds 2 or 5 digits to the end of all scanned UPC-A data. *Default = Off for both 2 Digit and 5 Digit Addenda.*



UPAAD21.

2 Digit Addenda On



UPAAD20.

* 2 Digit Addenda Off



UPAAD51.

5 Digit Addenda On



UPAAD50.

* 5 Digit Addenda Off

UPC-A Addenda Required

When **Required** is scanned, the scanner will only read UPC-A bar codes that have addenda. You must then turn on a 2 or 5 digit addenda listed on [page 7-36](#). *Default = Not Required.*



UPAARQ1.

Required



UPAARQ0.

* Not Required

Addenda Timeout

You can set a time during which the scanner looks for an addenda. If an addenda is not found within this time period, the data can be either transmitted or discarded, based on the setting you are using for [UPC-A Addenda Required](#) (see page 7-36). Set the length (in milliseconds) for this timeout by scanning the bar code below, then setting the timeout (from 0-65535 milliseconds) by scanning digits from the [Programming Chart](#), then scanning [Save](#). *Default = 100.*

Note: The Addenda Timeout setting is applied to all addenda and coupon code searches.



DLYADD.

Addenda Timeout

UPC-A Addenda Separator

When this feature is on, there is a space between the data from the bar code and the data from the addenda. When turned off, there is no space. *Default = Off.*



UPAADS1.

On



UPAADS0.

*** Off**

UPC-A Redundancy

If you are encountering errors when reading UPC-A bar codes, you may want to adjust the redundancy count. Redundancy adjusts the number of times a bar code is decoded before transmission, which may reduce the number of errors. Note that the higher the redundancy count, the longer it will take to decode the bar code. To adjust the redundancy, scan the **UPC-A Redundancy** bar code below, then scan a redundancy count between 0 and 10 on the [Programming Chart](#) inside the back cover of this manual. Then scan the [Save](#) bar code. *Default = 0.*



UPAVOT.

UPC-A Redundancy

UPC-A/EAN-13 with Extended Coupon Code

Use the following codes to enable or disable UPC-A and EAN-13 with Extended Coupon Code. When left on the default setting (**Off**), the scanner treats Coupon Codes and Extended Coupon Codes as single bar codes.

If you scan the **Allow Concatenation** code, when the scanner sees the coupon code and the extended coupon code in a single scan, it transmits both as separate symbologies. Otherwise, it transmits the first coupon code it reads.

If you scan the **Require Concatenation** code, the scanner must see and read the coupon code and extended coupon code in a single read to transmit the data. No data is output unless both codes are read.

Default = Off.



CPNENA0.

* Off



CPNENA1.

Allow Concatenation



CPNENA2.

Require Concatenation

UPC-A Number System 4 Addenda Required

This setting programs the scanner to require a coupon code only on UPC-A bar codes that begin with a “4.” The following settings can be programmed:

Require Coupon Code: All UPC-A bar codes that begin with a “4” must have a coupon code. The UPC-A bar code with the coupon code is then transmitted as a single, concatenated bar code. If a coupon code is not found within the [Addenda Timeout](#) period, the UPC-A bar code is discarded.

Don't Require Coupon Code: If you have selected **Require Coupon Code**, and you want to disable this feature, scan **Don't Require Coupon Code**. UPC-A bar codes are transmitted, depending on the setting you are using for [UPC-A/EAN-13 with Extended Coupon Code](#).

Default = Don't Require Coupon Code.



ARQSY40.

* Don't Require Coupon Code



ARQSY41.

Require Coupon Code

UPC-A Number System 5 Addenda Required

This setting programs the scanner to require any combination of a coupon code, a 2 digit addenda, or a 5 digit addenda on UPC-A bar codes that begin with a "5." The following settings can be programmed:

Require Coupon Code/Addenda: All UPC-A bar codes that begin with a "5" must have a coupon code, a 2 digit addenda, a 5 digit addenda, or a combination of these addenda. The UPC-A bar code with the coupon code and/or addenda is then transmitted as a single, concatenated bar code. If a coupon code and/or required addenda is not found within the [Addenda Timeout](#) period, the UPC-A bar code is discarded.

Don't Require Coupon Code/Addenda: If you have selected **Require Coupon Code/Addenda**, and you want to disable this feature, scan **Don't Require Coupon Code/Addenda**. UPC-A bar codes are transmitted, depending on the setting you are using for [UPC-A/EAN-13 with Extended Coupon Code](#).

Default = Don't Require Coupon Code/Addenda.



ARQSY50.

*** Don't Require Coupon Code/
Addenda**



ARQSY52.

Require 5 Digit Addenda



ARQSY54.

Require Coupon Code



ARQSY56.

**Require Coupon Code or 5 Digit
Addenda**



ARQSY51.

Require 2 Digit Addenda



ARQSY53.

Require 2 or 5 Digit Addenda



ARQSY55.

**Require Coupon Code or 2 Digit
Addenda**



ARQSY57.

**Require Coupon Code, 2 Digit
Addenda, or 5 Digit Addenda**

Addenda Timeout

You can set a time during which the scanner looks for a coupon code. If a coupon code is not found within this time period, the data can be either transmitted or discarded, based on the setting you are using for [UPC-A/EAN-13 with Extended Coupon Code](#) or [UPC-A Number System 4 Addenda Required](#). Set the length (in milliseconds) for this timeout by

scanning the bar code below, then setting the timeout (from 0-65535 milliseconds) by scanning digits from the [Programming Chart](#), then scanning **Save**. *Default = 100.*

Note: The Addenda Timeout setting is applied to all addenda and coupon code searches.



UPC-E0

<Default All UPC-E0 Settings>



UPC-E0 On/Off

Most U.P.C. bar codes lead with the 0 number system. To read these codes, use the **UPC-E0 On** selection. If you need to read codes that lead with the 1 number system, use [EAN/JAN-13](#) (page 7-45). *Default = On.*



UPC-E0 Expand

UPC-E Expand expands the UPC-E code to the 12 digit, UPC-A format. *Default = Off.*



UPC-E0 Number System

The numeric system digit of a UPC-A symbol is normally transmitted at the beginning of scanned data. When using UPC-E Expand, the unit can be programmed so it will not transmit it. *Default = On.*



UPEEXN1.

* On



UPEEXN0.

Off

UPC-E0 Number System and Check Digit

UPC-E0 sample showing the number system and check digit:



UPC-E0 Check Digit

Check Digit specifies whether the check digit should be transmitted at the end of the scanned data or not. *Default = Off.*



UPECKX1.

On



UPECKX0.

* Off

UPC-E0 Leading Zero

This feature allows the transmission of a leading zero (0) at the beginning of scanned data. To prevent transmission, scan **Off**. *Default = Off.*



UPENSX1.

On



UPENSX0.

* Off

UPC-E0 Addenda

This selection adds 2 or 5 digits to the end of all scanned UPC-E data. *Default = Off for both 2 Digit and 5 Digit Addenda.*



UPEAD21.

2 Digit Addenda On



UPEAD20.

* 2 Digit Addenda Off



UPEAD51.

5 Digit Addenda On



UPEAD50.

* 5 Digit Addenda Off

UPC-E0 Addenda Required

When **Required** is scanned, the scanner will only read UPC-E bar codes that have addenda. *Default = Not Required.*



UPEARQ1.

Required



UPEARQ0.

* Not Required

Addenda Timeout

You can set a time during which the scanner looks for an addenda. If an addenda is not found within this time period, the data can be either transmitted or discarded, based on the setting you are using for [UPC-E0 Addenda Required](#) (page 7-43). Set the length (in milliseconds) for this timeout by scanning the bar code below, then setting the timeout (from 0-65535 milliseconds) by scanning digits from the [Programming Chart](#), then scanning [Save](#). *Default = 100.*

Note: The Addenda Timeout setting is applied to all addenda and coupon code searches.



DLYADD.

Addenda Timeout

UPC-E0 Addenda Separator

When this feature is **On**, there is a space between the data from the bar code and the data from the addenda. When turned **Off**, there is no space. *Default = Off.*



UPEADS1.

On



UPEADS0.

*** Off**

UPC-E0 Redundancy

If you are encountering errors when reading UPC-E0 bar codes, you may want to adjust the redundancy count. Redundancy adjusts the number of times a bar code is decoded before transmission, which may reduce the number of errors. Note that the higher the redundancy count, the longer it will take to decode the bar code. To adjust the redundancy, scan the **UPC-E0 Redundancy** bar code below, then scan a redundancy count between 0 and 10 on the [Programming Chart](#) inside the back cover of this manual. Then scan the [Save](#) bar code. *Default = 1.*



UPEVOT.

UPC-E0 Redundancy

EAN/JAN-13

<Default All EAN/JAN Settings>



E13DFT.

EAN/JAN-13 On/Off



E13ENA1.

* On



E13ENAD.

Off

EAN/JAN-13 Check Digit

This selection allows you to specify whether the check digit should be transmitted at the end of the scanned data or not. *Default = On.*



E13CKX1.

* On



E13CKXD.

Off

EAN/JAN-13 Addenda

This selection adds 2 or 5 digits to the end of all scanned EAN/JAN-13 data. *Default = Off for both 2 Digit and 5 Digit Addenda.*



E13AD21.

2 Digit Addenda On



E13AD20.

*** 2 Digit Addenda Off**



E13AD51.

5 Digit Addenda On



E13AD50.

*** 5 Digit Addenda Off**

EAN/JAN-13 Addenda Required

When **Required** is scanned, the scanner will only read EAN/JAN-13 bar codes that have addenda. *Default = Not Required.*



E13ARQ1.

Required



E13ARQ0.

*** Not Required**

EAN-13 Beginning with 2 Addenda Required

This setting programs the scanner to require a 2 digit addenda only on EAN-13 bar codes that begin with a “2.” The following settings can be programmed:

Require 2 Digit Addenda: All EAN-13 bar codes that begin with a “2” must have a 2 digit addendum. The EAN-13 bar code with the 2 digit addendum is then transmitted as a single, concatenated bar code. If a 2 digit addendum is not found within the [Addenda Timeout](#) period, the EAN-13 bar code is discarded.

Note: if you are using [EAN-13 Beginning with 290 Addenda Required](#) (page 7-47), that setting will take precedence over this one.

Don't Require 2 Digit Addenda: If you have selected **Require 2 Digit Addenda**, and you want to disable this feature, scan **Don't Require 2 Digit Addenda**. EAN-13 bar codes are transmitted, depending on the setting you are using for [EAN/JAN-13 Addenda Required](#).

Default = Don't Require 2 Digit Addenda.



ARQSY20.

*** Don't Require 2 Digit Addenda**



ARQSY21.

Require 2 Digit Addenda

EAN-13 Beginning with 290 Addenda Required

This setting programs the scanner to require a 5 digit addenda only on EAN-13 bar codes that begin with "290." The following settings can be programmed:

Require 5 Digit Addenda: All EAN-13 bar codes that begin with "290" must have a 5 digit addendum. The EAN-13 bar code with the 5 digit addendum is then transmitted as a single, concatenated bar code. If a 5 digit addendum is not found within the [Addenda Timeout](#) period, the EAN-13 bar code is discarded.

Note: if you are using [EAN-13 Beginning with 2 Addenda Required](#) (page 7-46), this setting will take precedence.

Don't Require 5 Digit Addenda: If you have selected **Require 5 Digit Addenda**, and you want to disable this feature, scan **Don't Require 5 Digit Addenda**. EAN-13 bar codes are transmitted, depending on the setting you are using for [EAN/JAN-13 Addenda Required](#).

Default = Don't Require 5 Digit Addenda.



ARQ2900.

*** Don't Require 5 Digit Addenda**



ARQ2901.

Require 5 Digit Addenda

EAN-13 Beginning with 378/379 Addenda Required

This setting programs the scanner to require any combination of a 2 digit addenda or a 5 digit addenda on EAN-13 bar codes that begin with a "378" or "379." The following settings can be programmed:

Require Addenda: All EAN-13 bar codes that begin with a “378” or “379” must have a 2 digit addenda, a 5 digit addenda, or a combination of these addenda. The EAN-13 bar code with the addenda is then transmitted as a single, concatenated bar code. If the required addenda is not found within the [Addenda Timeout](#) period, the EAN-13 bar code is discarded.

Don't Require Addenda: If you have selected **Require Addenda**, and you want to disable this feature, scan **Don't Require Addenda**. EAN-13 bar codes are transmitted, depending on the setting you are using for [EAN/JAN-13 Addenda Required](#).

Default = Don't Require Addenda.



ARQ3780.

* **Don't Require Addenda**



ARQ3781.

Require 2 Digit Addenda



ARQ3782.

Require 5 Digit Addenda



ARQ3783.

Require 2 or 5 Digit Addenda

EAN-13 Beginning with 414/419 Addenda Required

This setting programs the scanner to require any combination of a 2 digit addenda or a 5 digit addenda on EAN-13 bar codes that begin with a “414” or “419.” The following settings can be programmed:

Require Addenda: All EAN-13 bar codes that begin with a “414” or “419” must have a 2 digit addenda, a 5 digit addenda, or a combination of these addenda. The EAN-13 bar code with the addenda is then transmitted as a single, concatenated bar code. If the required addenda is not found within the [Addenda Timeout](#) period, the EAN-13 bar code is discarded.

Don't Require Addenda: If you have selected **Require Addenda**, and you want to disable this feature, scan **Don't Require Addenda**. EAN-13 bar codes are transmitted, depending on the setting you are using for [EAN/JAN-13 Addenda Required](#).

Default = Don't Require Addenda.



ARQ4140.

* **Don't Require Addenda**



ARQ4142.

Require 5 Digit Addenda



ARQ4141.

Require 2 Digit Addenda



ARQ4143.

Require 2 or 5 Digit Addenda

EAN-13 Beginning with 434/439 Addenda Required

This setting programs the scanner to require any combination of a 2 digit addenda or a 5 digit addenda on EAN-13 bar codes that begin with a "434" or "439." The following settings can be programmed:

Require Addenda: All EAN-13 bar codes that begin with a "434" or "439" must have a 2 digit addenda, a 5 digit addenda, or a combination of these addenda. The EAN-13 bar code with the addenda is then transmitted as a single, concatenated bar code. If the required addenda is not found within the [Addenda Timeout](#) period, the EAN-13 bar code is discarded.

Don't Require Addenda: If you have selected **Require Addenda**, and you want to disable this feature, scan **Don't Require Addenda**. EAN-13 bar codes are transmitted, depending on the setting you are using for [EAN/JAN-13 Addenda Required](#).

Default = Don't Require Addenda.



ARQ4340.

* Don't Require Addenda



ARQ4342.

Require 5 Digit Addenda



ARQ4341.

Require 2 Digit Addenda



ARQ4343.

Require 2 or 5 Digit Addenda

EAN-13 Beginning with 977 Addenda Required

This setting programs the scanner to require a 2 digit addenda only on EAN-13 bar codes that begin with "977." The following settings can be programmed:

Require 2 Digit Addenda: All EAN-13 bar codes that begin with "977" must have a 2 digit addendum. The EAN-13 bar code with the 2 digit addendum is then transmitted as a single, concatenated bar code. If a 2 digit addendum is not found within the [Addenda Timeout](#) period, the EAN-13 bar code is discarded.

Don't Require 2 Digit Addenda: If you have selected **Require 2 Digit Addenda**, and you want to disable this feature, scan **Don't Require 2 Digit Addenda**. EAN-13 bar codes are transmitted, depending on the setting you are using for [EAN/JAN-13 Addenda Required](#).

Default = Don't Require 2 Digit Addenda.



ARQ9770.

* Don't Require 2 Digit Addenda



ARQ9771.

Require 2 Digit Addenda

EAN-13 Beginning with 978 Addenda Required

These settings program the scanner to require a 5 digit addenda only on EAN-13 bar codes that begin with "978." The following settings can be programmed:

Require 5 Digit Addenda: All EAN-13 bar codes that begin with “978” must have a 5 digit addendum. The EAN-13 bar code with the 5 digit addendum is then transmitted as a single, concatenated bar code. If a 5 digit addendum is not found within the [Addenda Timeout](#) period, the EAN-13 bar code is discarded.

Don't Require 5 Digit Addenda: If you have selected **Require 5 Digit Addenda**, and you want to disable this feature, scan **Don't Require 5 Digit Addenda**. EAN-13 bar codes are transmitted, depending on the setting you are using for [EAN/JAN-13 Addenda Required](#).

Default = Don't Require 5 Digit Addenda.



ARQ9780.

*** Don't Require 5 Digit Addenda**



ARQ9781.

Require 5 Digit Addenda

EAN-13 Beginning with 979 Addenda Required

These settings program the scanner to require a 5 digit addenda only on EAN-13 bar codes that begin with “979.” The following settings can be programmed:

Require 5 Digit Addenda: All EAN-13 bar codes that begin with “979” must have a 5 digit addendum. The EAN-13 bar code with the 5 digit addendum is then transmitted as a single, concatenated bar code. If a 5 digit addendum is not found within the [Addenda Timeout](#) period, the EAN-13 bar code is discarded.

Don't Require 5 Digit Addenda: If you have selected **Require 5 Digit Addenda**, and you want to disable this feature, scan **Don't Require 5 Digit Addenda**. EAN-13 bar codes are transmitted, depending on the setting you are using for [EAN/JAN-13 Addenda Required](#).

Default = Don't Require 5 Digit Addenda.



ARQ9790.

*** Don't Require 5 Digit Addenda**



ARQ9791.

Require 5 Digit Addenda

Addenda Timeout

You can set a time during which the scanner looks for an addenda. If an addenda is not found within this time period, the data can be either transmitted or discarded, based on the setting you are using for [EAN/JAN-13 Addenda Required](#). Set the length (in milliseconds) for this timeout by scanning the bar code below, then setting the timeout (from 0-65535 milliseconds) by scanning digits from the [Programming Chart](#), then scanning **Save**. *Default = 100.*

Note: The Addenda Timeout setting is applied to all addenda and coupon code searches.



DLYADD.

Addenda Timeout

EAN/JAN-13 Addenda Separator

When this feature is **On**, there is a space between the data from the bar code and the data from the addenda. When turned **Off**, there is no space. *Default = Off.*



E13ADS1.

On



E13ADS0.

*** Off**

Note: If you want to enable or disable EAN13 with Extended Coupon Code, refer to [UPC-A/EAN-13 with Extended Coupon Code](#) (page 7-38).

EAN/JAN-13 Redundancy

If you are encountering errors when reading EAN/JAN-13 bar codes, you may want to adjust the redundancy count. Redundancy adjusts the number of times a bar code is decoded before transmission, which may reduce the number of errors. Note that the higher the redundancy count, the longer it will take to decode the bar code. To adjust the redundancy, scan the **EAN/JAN-13 Redundancy** bar code below, then scan a redundancy count between 0 and 10 on the [Programming Chart](#) inside the back cover of this manual. Then scan the **Save** bar code. *Default = 0.*



E13VOT.

EAN/JAN-13 Redundancy

ISBN Translate

ISBNs are printed on books using the EAN-13 bar code symbology. To translate EAN-13 Bookland symbols into their equivalent ISBN number format, scan the **On** bar code below. *Default = Off.*



E13ISB1.

On



E13ISB0.

*** Off**

Convert ISBN to 13-Digit

When translating EAN-13 codes to the ISBN format, you can convert the bar code to a 13 digit format by scanning the **Convert to 13-Digit On** bar code below. *Default = Convert to 13-Digit Off.*



E13I131.

Convert to 13-Digit On



E13I130.

***Convert to 13-Digit Off**

ISBN Reformat

In normal use, the first two or three digits of an EAN-13 bar code identify the country of origin. The country prefixes are 978 and 979. To reformat ISBN codes so the country prefix is dropped out, scan the **Reformat On** bar code below. *Default = Reformat Off.*



E13IBR1.

Reformat On



E13IBR0.

***Reformat Off**

ISSN Translate

When **On** is scanned, EAN-13 977 Bookland symbols are translated into their equivalent 8-digit ISSN number format. For example, 9770123456787 will be transmitted as 01234560. *Default = Off.*



E13ISS1.

On



E13ISS0.

*** Off**

ISSN Reformat

When **Reformat On** is scanned, EAN-13 977 Bookland symbols are translated into their equivalent 8-digit ISSN number format, with hyphens added to the output. For example, 9770123456787 will be transmitted as 0123-456-0. (You must first scan ISSN **On** (page 7-54) before scanning **Reformat On**.) *Default = Reformat Off.*



E13ISR1.

Reformat On



E13ISR0.

*** Reformat Off**

EAN/JAN-8

<Default All EAN/JAN-8 Settings>



EA8DFT.

EAN/JAN-8 On/Off



EA8ENA1.

* On



EA8ENA0.

Off

EAN/JAN-8 Check Digit

This selection allows you to specify whether the check digit should be transmitted at the end of the scanned data or not. *Default = On.*



EA8CKX1.

* On



EA8CKX0.

Off

EAN/JAN-8 Addenda

This selection adds 2 or 5 digits to the end of all scanned EAN/JAN-8 data. *Default = Off for both 2 Digit and 5 Digit Addenda.*



EABAD21.

2 Digit Addenda On



EABAD20.

*** 2 Digit Addenda Off**



EABAD51.

5 Digit Addenda On



EABAD50.

*** 5 Digit Addenda Off**

EAN/JAN-8 Addenda Required

When **Required** is scanned, the scanner will only read EAN/JAN-8 bar codes that have addenda. *Default = Not Required.*



EABARQ1.

Required



EABARQ0.

*** Not Required**

Addenda Timeout

You can set a time during which the scanner looks for an addenda. If an addenda is not found within this time period, the data can be either transmitted or discarded, based on the setting you are using for [EAN/JAN-8 Addenda Required](#). Set the length (in milliseconds) for this timeout by

scanning the bar code below, then setting the timeout (from 0-65535 milliseconds) by scanning digits from the [Programming Chart](#), then scanning **Save**. *Default = 100.*

Note: The Addenda Timeout setting is applied to all addenda and coupon code searches.



DLYADD.

Addenda Timeout

EAN/JAN-8 Addenda Separator

When this feature is **On**, there is a space between the data from the bar code and the data from the addenda. When turned **Off**, there is no space. *Default = Off.*



EABADS1.

On



EABADS0.

*** Off**

EAN/JAN-8 Redundancy

If you are encountering errors when reading EAN/JAN-8 bar codes, you may want to adjust the redundancy count. Redundancy adjusts the number of times a bar code is decoded before transmission, which may reduce the number of errors. Note that the higher the redundancy count, the longer it will take to decode the bar code. To adjust the redundancy, scan the **EAN/JAN-8 Redundancy** bar code below, then scan a redundancy count between 0 and 10 on the [Programming Chart](#) inside the back cover of this manual. Then scan the **Save** bar code. *Default = 0.*



EABVOT.

EAN/JAN-8 Redundancy

MSI

<Default All MSI Settings>



MSI On/Off



MSI Check Character

Different types of check characters are used with MSI bar codes. You can program the scanner to read MSI bar codes with Type 10 check characters. *Default = Validate Type 10, but Don't Transmit.*

When Check Character is set to **Validate Type 10 and Transmit**, the scanner will only read MSI bar codes printed with the specified type check character(s), and will transmit the character(s) at the end of the scanned data.

When Check Character is set to **Validate Type 10, but Don't Transmit**, the unit will only read MSI bar codes printed with the specified type check character(s), but will not transmit the check character(s) with the scanned data.



MSICHK0.

* **Validate Type 10, but Don't Transmit**



MSICHK2.

Validate 2 Type 10 Characters, but Don't Transmit



MSICHK6.

Disable MSI Check Characters



MSICHK1.

Validate Type 10 and Transmit



MSICHK3.

Validate 2 Type 10 Characters and Transmit

MSI Redundancy

If you are encountering errors when reading MSI bar codes, you may want to adjust the redundancy count. Redundancy adjusts the number of times a bar code is decoded before transmission, which may reduce the number of errors. Note that the higher the redundancy count, the longer it will take to decode the bar code. To adjust the redundancy, scan the **MSI Redundancy** bar code below, then scan a redundancy count between 0 and 10 on the [Programming Chart](#) inside the back cover of this manual. Then scan the **Save** bar code. *Default = 0.*



MSIVOT.

MSI Redundancy

MSI Message Length

Scan the bar codes below to change the message length. Refer to [Message Length Description](#) (page 7-2) for additional information. Minimum and Maximum lengths = 1-80. Minimum Default = 3, Maximum Default = 80.



MSIMIN.

Minimum Message Length



MSIMAX.

Maximum Message Length

Plessey Code

< Default All Plessey Code Settings >



PLSDFT.

Plessey Code On/Off



PLSENA1.

On



PLSENA0.

*** Off**

Plessey Check Character

No Check Character indicates that the scanner reads and transmits bar code data with or without a check character.

When Check Character is set to **Validate, but Don't Transmit**, the unit only reads Plessey bar codes printed with a check character, but will not transmit the check character with the scanned data.

When Check Character is set to **Validate and Transmit**, the scanner only reads Plessey bar codes printed with a check character, and will transmit this character at the end of the scanned data. *Default = No Check Character.*



PLSCHK0.

* **No Check Character**



PLSCHK1.

Validate, but Don't Transmit



PLSCHK2.

Validate and Transmit

Plessey Redundancy

If you are encountering errors when reading Plessey bar codes, you may want to adjust the redundancy count. Redundancy adjusts the number of times a bar code is decoded before transmission, which may reduce the number of errors. Note that the higher the redundancy count, the longer it will take to decode the bar code. To adjust the redundancy, scan the **Plessey Redundancy** bar code below, then scan a redundancy count between 0 and 10 on the [Programming Chart](#) inside the back cover of this manual. Then scan the **Save** bar code. *Default = 0.*



PLSVOT.

Plessey Redundancy

Plessey Message Length

Scan the bar codes below to change the message length. Refer to [Message Length Description](#) (page 7-2) for additional information. Minimum and Maximum lengths = 1-80. Minimum Default = 3, Maximum Default = 80.



PLSMIN.

Minimum Message Length



PLSMAX.

Maximum Message Length

GS1 DataBar Omnidirectional

< Default All GS1 DataBar Omnidirectional Settings >



RSSDFT.

GS1 DataBar Omnidirectional On/Off



RSSENA1.

* On



RSSENA0.

Off

GS1 DataBar Omnidirectional Redundancy

If you are encountering errors when reading GS1 DataBar Omnidirectional bar codes, you may want to adjust the redundancy count. Redundancy adjusts the number of times a bar code is decoded before transmission, which may reduce the number of errors. Note that the higher the redundancy count, the longer it will take to decode the bar code. To adjust the redundancy, scan the **GS1 DataBar Omnidirectional Redundancy** bar code below, then scan a redundancy count between 0 and 10 on the [Programming Chart](#) inside the back cover of this manual. Then scan the **Save** bar code. *Default = 0.*



RSSVOT.

**GS1 DataBar Omnidirectional
Redundancy**

GS1 DataBar Limited

< Default All GS1 DataBar Limited Settings >



RSLDFT.

GS1 DataBar Limited On/Off



RSLENA1.

* On



RSLENA0.

Off

GS1 DataBar Limited Redundancy

If you are encountering errors when reading GS1 DataBar Limited bar codes, you may want to adjust the redundancy count. Redundancy adjusts the number of times a bar code is decoded before transmission, which may reduce the number of errors. Note that the higher the redundancy count, the longer it will take to decode the bar code. To adjust the redundancy, scan the **GS1 DataBar Limited Redundancy** bar code below, then scan a redundancy count between 0 and 10 on the [Programming Chart](#) inside the back cover of this manual. Then scan the **Save** bar code. *Default = 0.*



RSLVOT.

**GS1 DataBar Limited
Redundancy**

GS1 DataBar Expanded

< Default All GS1 DataBar Expanded Settings >



RSEDFT.

GS1 DataBar Expanded On/Off



RSEENA1.

* On



RSEENA0.

Off

GS1 DataBar Expanded Redundancy

If you are encountering errors when reading GS1 DataBar Expanded bar codes, you may want to adjust the redundancy count. Redundancy adjusts the number of times a bar code is decoded before transmission, which may reduce the number of errors. Note that the higher the redundancy count, the longer it will take to decode the bar code. To adjust the redundancy, scan the **GS1 DataBar Expanded Redundancy** bar code below, then scan a redundancy count between 0 and 10 on the [Programming Chart](#) inside the back cover of this manual. Then scan the **Save** bar code. *Default = 0.*



RSEVOT.

**GS1 DataBar Expanded
Redundancy**

GS1 DataBar Expanded Message Length

Scan the bar codes below to change the message length. Refer to [Message Length Description](#) (page 7-2) for additional information. Minimum and Maximum lengths = 1-80. Minimum Default = 3, Maximum Default = 80.



RSEMIN.

Minimum Message Length



RSEMAX.

Maximum Message Length

Trioptic Code

Trioptic Code is used for labeling magnetic storage media.



TRIENA1.

On



TRIENAO.

* Off

GS1 Emulation

The scanner can automatically format the output from any GS1 data carrier to emulate what would be encoded in an equivalent GS1-128 or GS1 DataBar symbol. GS1 data carriers include UPC-A and UPC-E, EAN-13 and EAN-8, ITF-14, GS1-128, and GS1-128 DataBar and GS1 Composites. (Any application that accepts GS1 data can be simplified since it only needs to recognize one data carrier type.)

If **GS1-128 Emulation** is scanned, all retail codes (U.P.C., UPC-E, EAN8, EAN13) are expanded out to 16 digits. If the AIM ID is enabled, the value will be the GS1-128 AIM ID,]C1 (see [Symbology Chart](#) on page A-1).

If **GS1 DataBar Emulation** is scanned, all retail codes (U.P.C., UPC-E, EAN8, EAN13) are expanded out to 16 digits. If the AIM ID is enabled, the value will be the GS1-DataBar AIM ID,]em (see [Symbology Chart](#) on page A-1).

If **GS1 Code Expansion Off** is scanned, retail code expansion is disabled, and UPC-E expansion is controlled by the [UPC-E0 Expand](#) (page 7-41) setting. If the AIM ID is enabled, the value will be the GS1-128 AIM ID,]C1 (see [Symbology Chart](#) on page A-1).

If **EAN8 to EAN13 Conversion** is scanned, all EAN8 bar codes are converted to EAN13 format.

Default = GS1 Emulation Off.



EANEMU1.
GS1-128 Emulation



EANEMU2.
GS1 DataBar Emulation



EANEMU3.
GS1 Code Expansion Off



EANEMU4.
EAN8 to EAN13 Conversion



EANEMU0.
*** GS1 Emulation Off**

Postal Codes

The following lists linear postal codes. Any combination of linear postal code selections can be active at a time.

China Post (Hong Kong 2 of 5)

<Default All China Post (Hong Kong 2 of 5) Settings>



CPCDFT.

China Post (Hong Kong 2 of 5) On/Off



CPCENA1.

On



CPCENAD.

* Off

China Post (Hong Kong 2 of 5) Redundancy

If you are encountering errors when reading China Post (Hong Kong 2 of 5) bar codes, you may want to adjust the redundancy count. Redundancy adjusts the number of times a bar code is decoded before transmission, which may reduce the number of errors. Note that the higher the redundancy count, the longer it will take to decode the bar code. To adjust the redundancy, scan the **China Post (Hong Kong 2 of 5) Redundancy** bar code below, then scan a redundancy count between 0 and 10 on the [Programming Chart](#) inside the back cover of this manual. Then scan the [Save](#) bar code. *Default = 0.*



CPCVOT.

**China Post (Hong Kong 2 of 5)
Redundancy**

China Post (Hong Kong 2 of 5) Message Length

Scan the bar codes below to change the message length. Refer to [Message Length Description](#) (page 7-2) for additional information. Minimum and Maximum lengths = 1-80. Minimum Default = 3, Maximum Default = 80.



CPCMIN.

Minimum Message Length



CPCMAX.

Maximum Message Length



Keyboard Function Relationships

The following Keyboard Function Code, Hex/ASCII Value, and Full ASCII “CTRL”+ relationships apply to all terminals that can be used with the scanner. Refer to [page 2-17](#) enable Control + ASCII mode.

Function Code	HEX/ASCII Value	Full ASCII “CTRL” +
NUL	00	@
SOH	01	A
STX	02	B
ETX	03	C
EOT	04	D
ENQ	05	E
ACK	06	F
BEL	07	G
BS	08	H
HT	09	I
LF	0A	J
VT	0B	K
FF	0C	L
CR	0D	M
SO	0E	N
SI	0F	O
DLE	10	P
DC1	11	Q
DC2	12	R
DC3	13	S
DC4	14	T
NAK	15	U
SYN	16	V
ETB	17	W
CAN	18	X
EM	19	Y
SUB	1A	Z
ESC	1B	[
FS	1C	\
GS	1D]
RS	1E	^
US	1F	_

The last five characters in the Full ASCII "CTRL" column ([\] 6 -), apply to US only. The following chart indicates the equivalents of these five characters for different countries.

Note: Not all countries may be supported by your device.

Country	Codes				
United States	[\]	6	-
Belgium	[<]	6	-
Scandinavia	8	<	9	6	-
France	^	8	\$	6	=
Germany		Ã	+	6	-
Italy		\	+	6	-
Switzerland		<	..	6	-
United Kingdom	[ç]	6	-
Denmark	8	\	9	6	-
Norway	8	\	9	6	-
Spain	[\]	6	-

Supported Interface Keys

ASCII	HEX	IBM AT/XT and PS/2 Compatibles, WYSE PC/AT Supported Keys	Apple Mac/iMac Supported Keys
NUL	00	Reserved	Reserved
SOH	01	Enter (KP)	Enter/Numpad Enter
STX	02	Cap Lock	CAPS
ETX	03	ALT make	ALT make
EOT	04	ALT break	ALT break
ENQ	05	CTRL make	CNTRL make
ACK	06	CTRL break	CNTRL break
BEL	07	CR/Enter	RETURN
BS	08	Reserved	APPLE make
HT	09	Tab	TAB
LF	0A	Reserved	APPLE break
VT	0B	Tab	TAB
FF	0C	Delete	Del

ASCII	HEX	IBM AT/XT and PS/2 Compatibles, WYSE PC/AT Supported Keys	Apple Mac/iMac Supported Keys
CR	0D	CR/Enter	RETURN
SO	0E	Insert	Ins Help
SI	0F	Escape	ESC
DLE	10	F11	F11
DC1	11	Home	Home
DC2	12	Print	Prnt Scrn
DC3	13	Back Space	BACKSPACE
DC4	14	Back Tab	LSHIFT TAB
NAK	15	F12	F12
SYN	16	F1	F1
ETB	17	F2	F2
CAN	18	F3	F3
EM	19	F4	F4
SUB	1A	F5	F5
ESC	1B	F6	F6
FS	1C	F7	F7
GS	1D	F8	F8
RS	1E	F9	F9
US	1F	F10	F10
DEL	7F		BACKSPACE



To Add a Test Code I.D. Prefix to All Symbologies

This selection allows you to turn on transmission of a Code I.D. before the decoded symbology. (See the [Symbology Chart](#), beginning on page A-1) for the single character code that identifies each symbology.) This action first clears all current prefixes, then programs a Code I.D. prefix for all symbologies. This is a temporary setting that will be removed when the unit is power cycled.



PRECA2,BK2995C80!

**Add Code I.D. Prefix to
All Symbologies (Temporary)**

Show Software Revision

Scan the bar code below to output the current software revision, unit serial number, and other product information for both the scanner and base.



REVINF.

Show Revision

Show Data Format

Scan the bar code below to show current data format settings.



DFMBK3?.

Data Format Settings

Test Menu

When you scan the Test Menu **On** code, then scan a programming code in this manual, the scanner displays the content of a programming code. The programming function will still occur, but in addition, the content of that programming code is output to the terminal.

Note: This feature should not be used during normal scanner operation.



TSTMNU1.

On



TSTMNU0.

*** Off**

EZConfig-Scanning Introduction

EZConfig-Scanning provides a wide range of PC-based programming functions that can be performed on a scanner connected to your PC's COM port. EZConfig-Scanning allows you to download upgrades to the scanner's firmware, change programmed parameters, and create and print programming bar codes. Using EZConfig-Scanning, you can even save/open the programming parameters for a scanner. This saved file can be e-mailed or, if required, you can create a single bar code that contains all the customized programming parameters and mail or fax that bar code to any location. Users in other locations can scan the bar code to load in the customized programming.

To communicate with a scanner, EZConfig-Scanning requires that the PC have at least one available serial communication port, or a serial port emulation using a physical USB port. If you are using the serial port and RS232 cable, an external power supply is required. When using a USB serial port emulation, only a USB cable is required.

EZConfig-Scanning Operations

The EZConfig-Scanning software performs the following operations:

Scan Data

Scan Data allows you to scan bar codes and display the bar code data in a window. Scan Data lets you send serial commands to the scanner and receive scanner response that can be seen in the Scan Data window. The data displayed in the Scan Data window can either be saved in a file or printed.

Configure

Configure displays the programming and configuration data of the scanner. The scanner's programming and configuration data is grouped into different categories. Each category is displayed as a tree

item under the “Configure” tree node in the application explorer. When one of these tree nodes is clicked, the right-hand side is loaded with the parameters' form belonging to that particular category. The Configure tree option has all the programming and configuration parameters specified for a scanner. You can set or modify these parameters as required. You can later write the modified settings to the scanner, or save them to a dcf file.

Installing EZConfig-Scanning from the Web

Note: EZConfig-Scanning requires .NET framework. If .NET is not installed on your PC, you will be prompted to install it during the EZConfig-Scanning installation.

1. Access the Honeywell web site at www.honeywellaidc.com
2. Click on the **Downloads** tab. Select **Software**.
3. Click on the dropdown for **Select Product Number** and select the number of your product.
4. Click on the listing for **EZConfig-Scanning**.
5. Follow the security directions as prompted on the screen.
6. When prompted, select **Save**, and save the file to the **c:\windows\temp** directory.
7. Once you have finished downloading the file, exit the web site.
8. Using Explorer, go to the **c:\windows\temp** file.
9. Double click on the **EZConfig-Scanning Setup.exe** file. Follow the screen prompts to install the EZConfig-Scanning program.
10. If you've selected the defaults during installation, you can click on **Start Menu-All Programs-Honeywell-EZConfig-Scanning**.



The serial programming commands can be used in place of the programming bar codes. Both the serial commands and the programming bar codes will program the scanner. For complete descriptions and examples of each serial programming command, refer to the corresponding programming bar code in this manual.

The device must be set to an RS232 interface (see [page 2-1](#)). The following commands can be sent via a PC COM port using terminal emulation software.

Conventions

The following conventions are used for menu and query command descriptions:

- parameter* A label representing the actual value you should send as part of a command.
- [*option*] An optional part of a command.
- {*Data*} Alternatives in a command.
- bold** Names of menus, menu commands, buttons, dialog boxes, and windows that appear on the screen.

Menu Command Syntax

Menu commands have the following syntax (spaces have been used for clarity only):

Prefix [:*Name*:] *Tag* *SubTag* {*Data*} [, *SubTag* {*Data*}] [: *Tag* *SubTag* {*Data*}] [...]
Storage

Prefix Three ASCII characters: **SYN M CR** (ASCII 22,77,13).

:Name: To send information to the scanner (with the base connected to host), use **:Voyager:** The default factory setting for a Voyager scanner is Voyager scanner. If the name is not known, a wildcard (*) can be used **.*:**

Note: *Since the base stores all work group settings and transfers to them to scanner once they are linked, changes are typically done to the base and not to the scanner.*

Tag A 3 character case-insensitive field that identifies the desired menu command group. For example, all RS232 configuration settings are identified with a Tag of **232**.

SubTag A 3 character case-insensitive field that identifies the desired menu command within the tag group. For example, the SubTag for the RS232 baud rate is **BAD**.

Data The new value for a menu setting, identified by the Tag and SubTag.

Storage A single character that specifies the storage table to which the command is applied. An exclamation point (!) performs the command's operation on the device's volatile menu configuration table. A period (.) performs the command's operation on the device's non-volatile menu configuration table. Use the non-volatile table only for semi-permanent changes you want saved through a power cycle.

Query Commands

Several special characters can be used to query the device about its settings.

- ^ What is the default value for the setting(s).
- ? What is the device's current value for the setting(s).
- * What is the range of possible values for the setting(s). (The device's response uses a dash (-) to indicate a continuous range of values. A pipe (|) separates items in a list of non-continuous values.)

:Name: Field Usage (Optional)

This command returns the query information from the scanner.

Tag Field Usage

When a query is used in place of a Tag field, the query applies to the *entire* set of commands available for the particular storage table indicated by the Storage field of the command. In this case, the SubTag and Data fields should not be used because they are ignored by the device.

SubTag Field Usage

When a query is used in place of a SubTag field, the query applies only to the subset of commands available that match the Tag field. In this case, the Data field should not be used because it is ignored by the device.

Data Field Usage

When a query is used in place of the Data field, the query applies only to the specific command identified by the Tag and SubTag fields.

Concatenation of Multiple Commands

Multiple commands can be issued within one Prefix/Storage sequence. Only the Tag, SubTag, and Data fields must be repeated for each command in the sequence. If additional commands are to be applied to the same Tag, then the new command sequence is separated with a comma (,) and only the SubTag and Data fields of the additional command are issued. If the additional command requires a different Tag field, the command is separated from previous commands by a semicolon (;).

Responses

The device responds to serial commands with one of three responses:

ACK Indicates a good command which has been processed.

ENQ Indicates an invalid Tag or SubTag command.

NAK Indicates the command was good, but the Data field entry was out of the allowable range for this Tag and SubTag combination, e.g., an entry for a minimum message length of 100 when the field will only accept 2 characters.

When responding, the device echoes back the command sequence with the status character inserted directly before each of the punctuation marks (the period, exclamation point, comma, or semicolon) in the command.

Examples of Query Commands

In the following examples, a bracketed notation [] depicts a non-displayable response.

Example: What is the range of possible values for Codabar Coding Enable?

Enter: **cbrena*.**

Response: **CBRENA0-1[ACK]**

This response indicates that Codabar Coding Enable (CBRENA) has a range of values from 0 to 1 (off and on).

Example: What is the default value for Codabar Coding Enable?

Enter: **cbrena^.**

Response: **CBRENA1[ACK]**

This response indicates that the default setting for Codabar Coding Enable (CBRENA) is 1, or on.

Example: What is the device's current setting for Codabar Coding Enable?

Enter: **cbrena?.**

Response: **CBRENA1[ACK]**

This response indicates that the device's Codabar Coding Enable (CBRENA) is set to 1, or on.

Example: What are the device's settings for all Codabar selections?

Enter: **cbr?.**

Response: **CBRENA1[ACK],**
SSX0[ACK],
CK20[ACK],
CCT1[ACK],
MIN2[ACK],

**MAX60[ACK],
DFT[ACK].**

This response indicates that the device's Codabar Coding Enable (CBRENA) is set to 1, or on;
the Start/Stop Character (SSX) is set to 0, or Don't Transmit;
the Check Character (CK2) is set to 0, or Not Required;
concatenation (CCT) is set to 1, or Enabled;
the Minimum Message Length (MIN) is set to 2 characters;
the Maximum Message Length (MAX) is set to 60 characters;
and the Default setting (DFT) has no value.

Serial Trigger Commands

You can activate and deactivate the scanner with serial trigger commands. The button is activated and deactivated by sending the following commands:

Activate: **SYN T CR**

Deactivate: **SYN U CR**

The scanner scans until a bar code has been read or until the deactivate command is sent. The scanner can also be set to turn itself off after a specified time has elapsed (see [Read Time-Out](#), which follows).

Read Time-Out

Use this selection to set a time-out (in milliseconds) of the scanner's button when using serial commands to trigger the scanner. Once the scanner has timed out, you can activate the scanner either by pressing the button or using a serial trigger command. After scanning the **Read Time-Out** bar code, set the time-out duration (from 0-300,000 milliseconds) by scanning digits on the [Programming Chart](#) inside the back cover, then scanning **Save**. *Default = 30,000 ms.*



TRGSTO.
Read Time-Out

Resetting the Standard Product Defaults

If you aren't sure what programming options are in your scanner, or you've changed some options and want the factory default settings restored, scan the **Standard Product Default Settings** bar code below.



DEFAULT.
Standard Product Default Settings

The charts on the following pages list the factory default settings for each of the commands (indicated by an asterisk (*) on the programming pages).

Menu Commands

Selection	Setting <i>* Indicates default</i>	Serial Command <i># Indicates a numeric entry</i>	Page
Product Default Settings			
Setting Custom Defaults	Set Custom Defaults	MNUCDF	1-8
	Save Custom Defaults	DEFAULT	1-8
Resetting the Custom Defaults	Activate Custom Defaults	DEFAULT	1-9
Resetting the Factory Defaults	Remove Custom Defaults	DEFOVR	1-9
	Activate Defaults	DEFAULT	1-9
Programming the Interface			
Plug and Play Codes	Keyboard Wedge: IBM PC AT and Compatibles with CR suffix	PAP_AT	2-1
	IBM PS2 Keyboard	PAPPS2	2-1
	RS232 Serial Port	PAP232	2-2
Plug and Play Codes: RS485	IBM Port 5B Interface	PAPP5B	2-2
	IBM Port 9B HHBCR-1 Interface	PAP9B1	2-2
	IBM Port 17 Interface	PAPP17	2-2
	IBM Port 9B HHBCR-2 Interface	PAP9B2	2-2
OPOS Mode	OPOS Mode	PAPOPS	2-3
Plug and Play Codes: IBM SurePos	USB IBM SurePos Handheld	PAPSPH	2-4
	USB IBM SurePos Tabletop	PAPSPT	2-4
IBM Secondary Interface	* Enable Secondary Interface	REMIFC1	2-4
	Disable Secondary Interface	REMIFC0	2-4

Selection	Setting <i>* Indicates default</i>	Serial Command <i># Indicates a numeric entry</i>	Page
Plug and Play Codes: USB	USB Keyboard (PC)	PAP124	2-5
	USB Keyboard (Mac)	PAP125	2-5
	USB Japanese Keyboard (PC)	PAP134	2-5
	USB HID	PAP131	2-5
HID Fallback Mode	HID Fallback Mode (Range 0-60 *5 minutes)	USBFTO	2-6

Selection	Setting <i>* Indicates default</i>	Serial Command <i># Indicates a numeric entry</i>	Page
USB Serial Commands	USB Serial Emulation for Windows XP, Windows Server 2003, and later	PAP130	2-6
	USB Serial Emulation for Windows 2000	REMIFCO;PAP130	2-6
	CTS/RTS Emulation On	USBCTS1	2-6
	CTS/RTS Emulation Off*	USBCTS0	2-6
	ACK/NAK Mode On	USBACK1	2-7
	ACK/NAK Mode Off*	USBACK0	2-7
	Communication Timeout (Range 0-65535) *2000 ms	232DLK#####	2-7
	Timeout Retries	HSTRTY	2-7
	Communication Timeout Beeper - Off	HSTTOA0	2-8
	*Communication Timeout Beeper - On	HSTTOA1	2-8
	NAK Retries (Range 0-255) *0	HSTRTN###	2-8
	BEL/CAN Mode On	BELCAN1	2-8
	BEL/CAN Mode Off*	BELCAN0	2-8

Selection	Setting <i>* Indicates default</i>	Serial Command <i># Indicates a numeric entry</i>	Page
Plug and Play Codes	Verifone Ruby Terminal	PAPRBY	2-9
	Gilbarco Terminal	PAPGLB	2-9
	Honeywell Bioptic Aux Port	PAPBIO	2-10
	Datalogic Magellan Bioptic Aux Port	PAPMAG	2-10
	NCR Bioptic Aux Port	PAPNCR	2-10
	Wincor Nixdorf Terminal	PAPWNX	2-11
	Wincor Nixdorf Beetle	PAPBTL	2-12

Selection	Setting <i>* Indicates default</i>	Serial Command <i># Indicates a numeric entry</i>	Page
Program Keyboard Country	*U.S.A.	KBDCTY0	2-13
	Arabic	KBDCTY91	2-13
	Belgium	KBDCTY1	2-13
	Chinese	KBDCTY92	2-13
	Finland	KBDCTY2	2-13
	France	KBDCTY3	2-13
	Germany	KBDCTY4	2-13
	Hungary	KBDCTY19	2-13
	IBM Financial	KBDCTY90	2-13
	Italy	KBDCTY5	2-13
	Japan ASCII	KBDCTY28	2-13
	Korea	KBDCTY93	2-13
	Russia	KBDCTY26	2-14
	Slovenia	KBDCTY31	2-14
	Spain	KBDCTY10	2-14
	Switzerland (German)	KBDCTY6	2-14
	Thailand	KBDCTY94	2-14
	Turkey Q	KBDCTY24	2-14
United Kingdom	KBDCTY7	2-14	
Vietnam	KBDCTY95	2-14	
Keyboard Wedge Modifiers			
ALT Mode	*Off	KBDALT0	2-15
	3 Characters	KBDALT6	2-15
	4 Characters	KBDALT7	2-15
Keyboard Style	*Regular	KBDSTY0	2-15
	Caps Lock	KBDSTY1	2-15
	Shift Lock	KBDSTY2	2-15
	Autocaps via NumLock	KBDSTY7	2-16
	Emulate External Keyboard	KBDSTY5	2-16

Selection	Setting <i>* Indicates default</i>	Serial Command <i># Indicates a numeric entry</i>	Page
Keyboard Conversion	*Keyboard Conversion Off	KBDCNV0	2-16
	Convert all Characters to Upper Case	KBDCNV1	2-16
	Convert all Characters to Lower Case	KBDCNV1	2-16
Keyboard Modifiers	*Control + ASCII Off	KBDCAS0	2-17
	DOS Mode Control + ASCII	KBDCAS1	2-17
	Windows Mode Control + ASCII	KBDCAS2	2-17
	Windows Mode Prefix/Suffix Off	KBDCAS3	2-17
	*Numeric Keypad Off	KBDNPS0	2-17
	Numeric Keypad On	KBDNPS1	2-17
Inter-Scan Code Delay	Inter-Scan Code Delay *0 (Range 1-30 msecs)	KBDDLY##	2-18
<F0> Break Character	Suppress <F0> Break Character	KBDF0B0	2-18
	*Transmit <F0> Break Character	KBDF0B1	2-18
Keyboard Wedge Defaults	Reset Keyboard Wedge Defaults	KBDDFT	2-18

Selection	Setting <i>* Indicates default</i>	Serial Command <i># Indicates a numeric entry</i>	Page
RS-232 Modifiers			
RS232 Baud Rate	300 BPS	232BAD0	2-19
	600 BPS	232BAD1	2-19
	1200 BPS	232BAD2	2-19
	2400 BPS	232BAD3	2-19
	4800 BPS	232BAD4	2-19
	*9600 BPS	232BAD5	2-19
	19200 BPS	232BAD6	2-19
	38400 BPS	232BAD7	2-19
	57600 BPS	232BAD8	2-19
	115200 BPS	232BAD9	2-19

Selection	Setting <i>* Indicates default</i>	Serial Command <i># Indicates a numeric entry</i>	Page
Word Length: Data Bits, Stop Bits, and Parity	7 Data, 1 Stop, Parity Even	232WRD3	2-20
	7 Data, 1 Stop, Parity None	232WRD0	2-20
	7 Data, 1 Stop, Parity Odd	232WRD6	2-20
	7 Data, 2 Stop, Parity Even	232WRD4	2-20
	7 Data, 2 Stop, Parity None	232WRD1	2-20
	7 Data, 2 Stop, Parity Odd	232WRD7	2-20
	8 Data, 1 Stop, Parity Even	232WRD5	2-20
	*8 Data, 1 Stop, Parity None	232WRD2	2-20
	8 Data, 1 Stop, Parity Odd	232WRD8	2-20
	7 Data, 1 Stop, Parity Space	232WRD9	2-20
	7 Data, 2 Stop, Parity Space	232WRD10	2-21
	8 Data, 1 Stop, Parity Space	232WRD11	2-21
	7 Data, 1 Stop, Parity Mark	232WRD12	2-21
	7 Data, 2 Stop, Parity Mark	232WRD13	2-21
	8 Data, 1 Stop, Parity Mark	232WRD14	2-21

Selection	Setting <i>* Indicates default</i>	Serial Command <i># Indicates a numeric entry</i>	Page
RS232 Handshaking	*RTS/CTS Off	232CTS0	2-22
	Flow Control, No Timeout	232CTS1	2-22
	Character-Based Flow Control, No Timeout	232CTS7	2-22
	Two-Direction Flow Control	232CTS2	2-22
	Flow Control with Timeout	232CTS3	2-22
	Character-Based Flow Control with Timeout	232CTS9	2-22
	*RTS/CTS Off, RTS Inactive	232CTS10	2-22
	RS232 Timeout (Range 1-5100) *1000 ms	232DEL####	2-22
	*XON/XOFF Off	232XON0	2-23
	XON/XOFF On	232XON1	2-23
	*ACK/NAK Off	232ACK0	2-23
	ACK/NAK On	232ACK1	2-23
	Communication Timeout (Range 1-65535) *2000 ms	232DLK#####	2-23
	Communication Timeout Beeper - Off	HSTTOA0	2-24
	*Communication Timeout Beeper - On	HSTTOA1	2-24
	BEL/CAN Mode On	BELCAN1	2-25
	*BEL/CAN Mode Off	BELCAN0	2-25

Selection	Setting <i>* Indicates default</i>	Serial Command <i># Indicates a numeric entry</i>	Page
RS232 Defaults	Reset RS232 Defaults	232DFT	2-25
NCR Modifiers			
NCR ACK/NAK	*NCR ACK/NAK Off	NCRACK0	2-25
	NCR ACK/NAK On	NCRACK1	2-25
Block Check Character	*Transmit	NCRBCC1	2-26
	Don't Transmit	NCRBCC0	2-26
NCR Prefix/Suffix	NCR Prefix	NCRPR2##	2-26
	NCR Suffix	NCRSF2##	2-26
	Transmit Prefix/Suffix	NCRBCP1	2-27
	*Don't Transmit Prefix/Suffix	NCRBCP0	2-27
NCR NOF (Not-on-File) Error	On	NCRRAZ1	2-27
	*Off	NCRRAZ0	2-27
Scanner to Biopic Communication	*Packet Mode Off	232PKT0	2-28
	Packet Mode On	232PKT2	2-28
	*ACK/NAK Off	232ACK0	2-28
	ACK/NAK On	232ACK1	2-28
	Communication Timeout (Range 1-65535) *2000 ms	232DLK#####	2-28
<i>Cordless System Operation</i>			
<i>Note: This section applies only to cordless systems. It does not apply to corded scanners.</i>			
Base Power Communication Indicator	*On	.*:BASRED1	3-7
	Off	.*:BASRED0	3-7
Reset Scanner	Reset Scanner	RESET_	3-8
Scanning While in Base Cradle	Scanning in Cradle Off	BT_SIC0	3-8
	*Scanning in Cradle On	BT_SIC1	3-8

Selection	Setting <i>* Indicates default</i>	Serial Command <i># Indicates a numeric entry</i>	Page
Paging Mode	*On	BEPPGE1	3-9
	Off	BEPPGE0	3-9
Paging Pitch	Low (*1000) (min 100Hz)	BEPPFQ1000	3-9
	Medium (3250)	BEPPFQ3250	3-9
	High (4200) (min 5000Hz)	BEPPFQ4200	3-9
Scanner Address	Scanner Address	BT_LDA	3-9
Base Address	Base Address	:::BASLDA	3-10
Scanner Modes	Charge Only Mode	:::BASLNK0	3-10
	*Charge and Link Mode	:::BASLNK1	3-10
	Locked Link Mode	:::BASCON0	3-11
	*Open Link Mode	:::BASCON1	3-11
	Unlink Scanner	BT_RMV	3-11
	Override Locked Scanner	BT_RPL1	3-12
Out-of-Range Alarm	Alarm Off	BT_ORW0	3-12
	*Alarm On	BT_ORW1	3-12
	Scanner Alarm Duration (Range 1 - 3000 sec (*1))	BT_ORD	3-12
Scanner Power Time-Out Timer	Timer Off	BT_LPT0	3-13
	200 Seconds	BT_LPT200	3-13
	400 Seconds	BT_LPT400	3-13
	900 Seconds	BT_LPT900	3-13
	3600 Seconds	BT_LPT3600	3-13
	7200 Seconds	BT_LPT7200	3-13
Batch Mode	Automatic Batch Mode	BATENA1	3-14
	*Batch Mode Off	BATENA0	3-14
	Inventory Batch Mode	BATENA2	3-14

Selection	Setting <i>* Indicates default</i>	Serial Command <i># Indicates a numeric entry</i>	Page
Batch Mode Beep	*Off	BATBEP0	3-14
	On	BATBEP1	3-14
Batch Mode Quantity	*Off	BATQTY0	3-15
	On	BATQTY1	3-15
Quantity Codes	0	BATNUM0	3-16
	1	BATNUM1	3-16
	2	BATNUM2	3-16
	3	BATNUM3	3-16
	4	BATNUM4	3-16
	5	BATNUM5	3-16
	6	BATNUM6	3-16
	7	BATNUM7	3-16
	8	BATNUM8	3-16
9	BATNUM9	3-16	
Delete Last Code	Delete Last Code	BATUND	3-17
Record Counter	*Record Counter Off	BATENT0	3-17
	Record Counter On	BATENT1	3-17
Total Records	Total Records	BATNRC	3-17
Batch Mode Output Order	*FIFO	BATLIF0	3-18
	LIFO	BATLIF1	3-18
Clear All Codes After Transmission	*Don't Clear All Codes After Transmission	BATCLX0	3-18
	Clear All Codes After Transmission	BATCLX1	3-18
Clear All Codes	Clear All Codes	BATCLR	3-18
Transmit Records Automatically	*Don't Transmit Records Automatically	BATATX0	3-19
	Transmit Records Automatically	BATATX1	3-19
Transmit Records to Host	Transmit Inventory Records	BAT_TX	3-19

Selection	Setting <i>* Indicates default</i>	Serial Command <i># Indicates a numeric entry</i>	Page
Batch Mode Transmit Delay	*Off	BATDLY0	3-20
	Short (ms)	BATDLY250	3-20
	Medium (ms)	BATDLY500	3-20
	Long (ms)	BATDLY1000	3-20
Scanner Name	Scanner Name	BT_NAM	3-21
Bluetooth Connection	Non-Base BT Connection	BT_DNG9	3-22
	Base BT Connection	BT_DNG8	3-22
Bluetooth PIN Code	Bluetooth PIN *0000	BT_PIN	3-22
Auto Reconnect Mode	*Auto Reconnect On	BT_ACM1	3-23
	Auto Reconnect Off	BT_ACM0	3-23
Maximum Link Attempts	Maximum Link Attempts Range 0-255 (*0)	BT_MLA###	3-24
Relink Time-Out	Relink Time-Out Range 0-100 (*3)	BT_RLT###	3-24
Reset	Reset Base	RESET_	3-25
	Reset Scanner	:::RESET_	3-25
<i>Input/Output Selections</i>			
Power Up Beeper	Power Up Beeper Off - Scanner	BEPPWR0	4-1
	*Power Up Beeper On - Scanner	BEPPWR1	4-1
Beep on BEL Character	Beep on BEL On	BELBEP1	4-1
	*Beep on BEL Off	BELBEP0	4-1
Beeper - Good Read	Off	BEPBEP0	4-2
	*On	BEPBEP1	4-2
Beeper Volume - Good Read	Off	BEPLVL0	4-2
	Low	BEPLVL1	4-2
	Medium	BEPLVL2	4-2
	*High	BEPLVL3	4-2

Selection	Setting <i>* Indicates default</i>	Serial Command <i># Indicates a numeric entry</i>	Page
Beeper Pitch - Good Read (Frequency)	Low (1600 Hz)	BEPFQ11600	4-3
	*Medium (2350 Hz)	BEPFQ12350	4-3
	High (4200 Hz)	BEPFQ14200	4-3
Beeper - Transmit Order	*Before Transmission	BEPWHN1	4-3
	After Transmission	BEPWHN2	4-3
Beeper Pitch - Error (Frequency)	*Razz (100 Hz)	BEPFQ2100	4-3
	Medium (2000 Hz)	BEPFQ22000	4-3
	High (4200 Hz)	BEPFQ24200	4-3
Beeper Duration - Good Read	*Normal Beep	BEPBIP0	4-4
	Short Beep	BEPBIP1	4-4
Number of Beeps - Good Read	Range 1 - 9 (*1)	BEPRPT#	4-4
Number of Beeps - Error	Range 1 - 9 (*1)	BEPERR#	4-5

Selection	Setting <i>* Indicates default</i>	Serial Command <i># Indicates a numeric entry</i>	Page
LED Settings	Red LED Off	LEDFN10	4-6
	Green LED Off	LEDFN20	4-6
	Red LED On with Good Scan	LEDFN11	4-6
	*Green LED On with Good Scan	LEDFN21	4-6
	*Red LED On with Laser	LEDFN12	4-6
	Green LED On with Laser	LEDFN22	4-6
	Red LED On when CodeGate Disabled	LEDFN14	4-6
	Green LED On when CodeGate Disabled	LEDFN24	4-6
	Red LED On when In-Stand	LEDFN18	4-6
	Green LED On when In-Stand	LEDFN28	4-6
	Red LED On with CTS	LEDFN1128	4-7
	Green LED On with CTS	LEDFN2128	4-7
	Red LED when Battery is Low	LEDFN11024	
	Green LED when Battery is Low	LEDFN21024	

Selection	Setting <i>* Indicates default</i>	Serial Command <i># Indicates a numeric entry</i>	Page
LED Brightness	Red Off	LEDIN10	4-8
	Green Off	LEDIN20	4-8
	Red Low	LEDIN11	4-8
	Green Low	LEDIN21	4-8
	Red Medium	LEDIN12	4-8
	Green Medium	LEDIN22	4-8
	*Red High	LEDIN13	4-8
	*Green High	LEDIN23	4-8

Selection	Setting <i>* Indicates default</i>	Serial Command <i># Indicates a numeric entry</i>	Page
In-Stand and Out-of-Stand Settings	In-Stand Defaults	AISDFT	4-9
	Out-of-Stand Defaults	AOSDFT	4-9
	Presentation Mode Out-of-Stand	PAPPM1	4-9
	Presentation Mode with CodeGate Out-of-Stand	PAPPM2	4-9
	Manual Activation Mode Off In-Stand	AISMEN0	4-10
	*Manual Activation Mode On In-Stand	AISMEN1	4-10
	Manual Activation Mode Off Out-of-Stand	AOSMEN0	4-10
	*Manual Activation Mode On Out-of-Stand	AOSMEN1	4-10
	Do Not End Manual Activation After Good Read In-Stand	AISMGD0	4-10
	*End Manual Activation After Good Read In-Stand	AISMGD1	4-10
	Do Not End Manual Activation After Good Read Out-of-Stand	AOSMGD0	4-10
	*End Manual Activation After Good Read Out-of-Stand	AOSMGD1	4-10
	Laser Timeout - Button Hold In-Stand (Range 1 - 65525) *5000 ms	AISMPT#####	4-11

Selection	Setting <i>* Indicates default</i>	Serial Command <i># Indicates a numeric entry</i>	Page
In-Stand and Out-of- Stand Settings (continued)	Laser Timeout - Button Release In- Stand (Range 1 - 65525) *0 ms	AISMRT#####	4-11
	Laser Timeout - Button Hold Out-of- Stand (Range 1 - 65525) *5000 ms	AOSMPT#####	4-11
	Laser Timeout - Button Release Out- of-Stand (Range 1 - 65525) *0 ms	AOSMRT#####	4-11
	*CodeGate Off In- Stand	AISCGD0	4-12
	CodeGate On In- Stand	AISCGD1	4-12
	CodeGate Off Out- of-Stand	AOSCGD0	4-12
	*CodeGate On Out- of-Stand	AOSCGD1	4-12
	Object Detection Mode Off In-Stand	AISOEN0	4-12
	Object Detection Mode On Out-of- Stand	AOSOEN1	4-12
	*Object Detection Mode Off Out-of- Stand	AOSOEN0	4-12
	*Object Detection Mode On In-Stand	AISOEN1	4-12
	Do Not End Object Detection After Good Read In-Stand	AISOGD0	4-13

Selection	Setting <i>* Indicates default</i>	Serial Command <i># Indicates a numeric entry</i>	Page
In-Stand and Out-of- Stand Settings (continued)	*End Object Detection After Good Read In-Stand	AISOGD1	4-13
	Do Not End Object Detection After Good Read Out-of- Stand	AOSOGD0	4-13
	*End Object Detection After Good Read Out-of- Stand	AOSOGD1	4-13
	Object Detection Laser Timeout In- Stand (Range 1 - 65525) *5000 ms	AISODT#####	4-13
	Object Detection Laser Timeout Out- of-Stand (Range 1 - 65525) *5000 ms	AOSODT#####	4-13
	*Object Detection Distance - Short In- Stand	AISRNG2	4-14
	Object Detection Distance - Long In- Stand	AISRNG1	4-14
	Object Detection Distance - Short Out-of-Stand	AOSRNG2	4-14
	*Object Detection Distance - Long Out- of-Stand	AOSRNG1	4-14

Selection	Setting <i>* Indicates default</i>	Serial Command <i># Indicates a numeric entry</i>	Page
Character Activation Mode	*Off	HSTCEN0	4-14
	On	HSTCEN1	4-14
	Activation Character	HSTACH##	4-15
	Do Not End Character Activation After Good Read	HSTCGD0	4-15
	*End Character Activation After Good Read	HSTCGD1	4-15
	Character Activation Laser Timeout (Range 1 - 65525) *5000 ms	HSTCDT#####	4-15
Character Deactivation Mode	*Off	HSTDEN0	4-16
	On	HSTDEN1	4-16
	Deactivation Character	HSTDCH##	4-16
Reread Delay	Short (500 ms)	DLYRRD500	4-17
	*Medium (750 ms)	DLYRRD750	4-17
	Long (1000 ms)	DLYRRD1000	4-17
	Extra Long (2000 ms)	DLYRRD2000	4-17
User-Specified Reread Delay	Range 0 - 30,000 ms	DLYRRD#####	4-17
Output Sequence Editor	Enter Sequence	SEQBLK	4-20
	Default Sequence	SEQDFT	4-20
Sequence Timeout	(Range 1 - 65535) *5000 ms	SEQDLY#####	4-20
Sequence Match Beeper	*On	SEQBEP1	4-21
	Off	SEQBEP0	4-21
Partial Sequence	Transmit Partial Sequence	SEQTTS1	4-21
	*Discard Partial Sequence	SEQTTS0	4-21

Selection	Setting <i>* Indicates default</i>	Serial Command <i># Indicates a numeric entry</i>	Page
Require Output Sequence	Required	SEQ_EN2	4-22
	On/Not Required	SEQ_EN1	4-22
	*Off	SEQ_EN0	4-22
No Read	On	SHWNRD1	4-22
	*Off	SHWNRD0	4-22
Prefix/Suffix Selections			
Add CR Suffix to All Symbologies		VSUF CR	5-3
Prefix	Add Prefix	PREBK2##	5-3
	Clear One Prefix	PRECL2	5-3
	Clear All Prefixes	PRECA2	5-3
Suffix	Add Suffix	SUFBK2##	5-4
	Clear One Suffix	SUFCL2	5-4
	Clear All Suffixes	SUFCA2	5-4
Transmit Alternate Extended ASCII Characters	*Transmit Alternate Extended ASCII	KBDEXT0	5-4
	Transmit Normal Extended ASCII	KBDEXT1	5-4
Function Code Transmit	*Enable	RMVFNC0	5-6
	Disable	RMVFNC1	5-6
Communication Check Character	*None	HSTXRC0	5-6
	LRC Starts on 1st Character	HSTXRC1	5-6
	LRC Starts on 2nd Character	HSTXRC2	5-6
	CRC	HSTXRC3	5-6
Intercharacter Delay	Range 0 - 1000 (5ms increments)	DLYCHR##	5-7
User Specified Intercharacter Delay	Delay Length 0 - 1000 (5ms increments)	DLYCRX##	5-8
	Character to Trigger Delay	DLY_XX##	5-8

Selection	Setting <i>* Indicates default</i>	Serial Command <i># Indicates a numeric entry</i>	Page
Interfunction Delay	Range 0 - 1000 (5ms increments)	DLYFNC##	5-8
Intermessage Delay	Range 0 - 1000 (5ms increments)	DLYMSG##	5-9
Data Formatter Selections			
Data Format Editor	*Default Data Format (None)	DFMDF3	6-1
	Enter Data Format	DFMBK3##	6-2
	Clear One Data Format	DFMCL3	6-3
	Clear All Data Formats	DFMCA3	6-3
Data Formatter	Data Formatter Off	DFM_EN0	6-8
	*Data Formatter On, Not Required, Keep Prefix/Suffix	DFM_EN1	6-9
	Data Format Required, Keep Prefix/Suffix	DFM_EN2	6-9
	Data Formatter On, Not Required, Drop Prefix/Suffix	DFM_EN3	6-9
	Data Format Required, Drop Prefix/Suffix	DFM_EN4	6-9
Data Format Non-Match Error Tone	*Data Format Non-Match Error Tone On	DFMDEC0	6-10
	Data Format Non-Match Error Tone Off	DFMDEC1	6-10

Selection	Setting <i>* Indicates default</i>	Serial Command <i># Indicates a numeric entry</i>	Page
Primary/Alternate Data Formats	Primary Data Format	ALTFNM0	6-10
	Data Format 1	ALTFNM1	6-10
	Data Format 2	ALTFNM2	6-10
	Data Format 3	ALTFNM3	6-10
Single Scan Data Format Change	Single Scan-Primary Data Format	VSAF_0	6-11
	Single Scan-Data Format 1	VSAF_1	6-11
	Single Scan-Data Format 2	VSAF_2	6-11
	Single Scan-Data Format 3	VSAF_3	6-11
Symbologies			
All Symbologies	All Symbologies Off	ALLENA0	7-1
	All Symbologies On	ALLENA1	7-1
Codabar	Default All Codabar Settings	CBRDFT	7-3
	Off	CBRENA0	7-3
	*On	CBRENA1	7-3
Codabar Start/Stop Char.	*Don't Transmit	CBRSSX0	7-3
	Transmit	CBRSSX1	7-3

Selection	Setting <i>* Indicates default</i>	Serial Command <i># Indicates a numeric entry</i>	Page
Codabar Check Char.	*No Check Char.	CBRCK20	7-4
	Validate Modulo 16, But Don't Transmit	CBRCK21	7-4
	Validate Modulo 16, and Transmit	CBRCK22	7-4
	Validate Modulo 7 CD, But Don't Transmit	CBRCK23	7-4
	Validate Modulo 7 CD, and Transmit	CBRCK24	7-4
	Validate CLSI, But Don't Transmit	CBRCK25	7-4
	Validate CLSI, and Transmit	CBRCK26	7-4
Codabar Concatenation	*Off	CBRCCT0	7-5
	On	CBRCCT1	7-5
	Require	CBRCCT2	7-5
	Concatenation Timeout	DLYCCT	7-5
Codabar Redundancy	Range (0 - 10) *0	CBRVOT##	7-5
Codabar Message Length	Minimum (1 - 80) *3	CBRMIN##	7-6
	Maximum (1 - 80) *80	CBRMAX##	7-6
Code 39	Default All Code 39 Settings	C39DFT	7-7
	Off	C39ENA0	7-7
	*On	C39ENA1	7-7
Code 39 Start/Stop Char.	*Don't Transmit	C39SSX0	7-7
	Transmit	C39SSX1	7-7

Selection	Setting <i>* Indicates default</i>	Serial Command <i># Indicates a numeric entry</i>	Page
Code 39 Check Char.	*No Check Char.	C39CK20	7-8
	Validate, But Don't Transmit	C39CK21	7-8
	Validate, and Transmit	C39CK22	7-8
Code 39 Redundancy	Range (0 - 10) *0	C39VOT##	7-8
Code 39 Message Length	Minimum (1 - 80) *3	C39MIN##	7-8
	Maximum (1 - 80) *80	C39MAX##	7-8
Code 32 Pharmaceutical (PARAF)	*Off	C39B320	7-9
	On	C39B321	7-9
Code 39 Full ASCII	*Off	C39ASC0	7-10
	On	C39ASC1	7-10
Interleaved 2 of 5	Default All Interleaved 2 of 5 Settings	I25DFT	7-11
	Off	I25ENA0	7-11
	*On	I25ENA1	7-11
Follett Formatting	*Off	I25FOL0	7-11
	On	I25FOL1	7-11
NULL Characters	*Off	I25NUL0	7-11
	On	I25NUL1	7-11
Interleaved 2 of 5 Check Digit	*No Check Char.	I25CK20	7-12
	Validate, But Don't Transmit	I25CK21	7-12
	Validate, and Transmit	I25CK22	7-12
Interleaved 2 of 5 Redundancy	Range (0 - 10) *0	I25VOT##	7-12
Interleaved 2 of 5 Message Length	Minimum (1 - 80) *6	I25MIN##	7-13
	Maximum (1 - 80) *80	I25MAX##	7-13

Selection	Setting <i>* Indicates default</i>	Serial Command <i># Indicates a numeric entry</i>	Page
NEC 2 of 5	Default All NEC 2 of 5 Settings	N25DFT	7-13
	*Off	N25ENA0	7-13
	On	N25ENA1	7-13
NEC 2 of 5 Check Digit	*No Check Char.	N25CK20	7-14
	Validate, But Don't Transmit	N25CK21	7-14
	Validate, and Transmit	N25CK22	7-14
NEC 2 of 5 Redundancy	Range (0 - 10) *0	N25VOT##	7-14
NEC 2 of 5 Message Length	Minimum (1 - 80) *3	N25MIN##	7-14
	Maximum (1 - 80) *80	N25MAX##	7-14
Code 93	Default All Code 93 Settings	C93DFT	7-15
	Off	C93ENA0	7-15
	*On	C93ENA1	7-16
Code 93 Redundancy	Range (0 - 10) *0	C93VOT##	7-15
Code 93 Message Length	Minimum (1 - 80) *3	C93MIN##	7-16
	Maximum (1 - 80) *80	C93MAX##	7-16
Straight 2 of 5 Industrial	Default All Straight 2 of 5 Industrial Settings	R25DFT	7-16
	*Off	R25ENA0	7-16
	On	R25ENA1	7-16
Straight 2 of 5 Industrial Redundancy	Range (0 - 10) *0	R25VOT##	7-17
Straight 2 of 5 Industrial Message Length	Minimum (1 - 80) *3	R25MIN##	7-17
	Maximum (1 - 80) *80	R25MAX##	7-17

Selection	Setting <i>* Indicates default</i>	Serial Command <i># Indicates a numeric entry</i>	Page
Straight 2 of 5 IATA	Default All Straight 2 of 5 IATA Settings	A25DFT	7-18
Straight 2 of 5 IATA	*Off	A25ENA0	7-18
	On	A25ENA1	7-18
Straight 2 of 5 IATA Redundancy	Range (0 - 10) *0	A25VOT##	7-18
Straight 2 of 5 IATA Message Length	Minimum (1 - 80) *13	A25MIN##	7-19
	Maximum (1 - 80) *15	A25MAX##	7-19
Matrix 2 of 5	Default All Matrix 2 of 5 Settings	X25DFT	7-19
	*Off	X25ENA0	7-19
	On	X25ENA1	7-19
Matrix 2 of 5 Redundancy	Range (0 - 10) *0	X25VOT##	7-20
Matrix 2 of 5 Message Length	Minimum (1 - 80) *3	X25MIN##	7-20
	Maximum (1 - 80) *80	X25MAX##	7-20
Matrix 2 of 5 Check Char.	*No Check Char.	X25CK20	7-20
	Validate, But Don't Transmit	X25CK21	7-20
	Validate and Transmit	X25CK22	7-20
Code 11	Default All Code 11 Settings	C11DFT	7-21
	*Off	C11ENA0	7-21
	On	C11ENA1	7-21

Selection	Setting <i>* Indicates default</i>	Serial Command <i># Indicates a numeric entry</i>	Page
Code 11 Check Digits Required	1 Check Digit Required	C11CK20	7-21
	*2 Check Digits Required	C11CK21	7-21
	Auto Select Check Digits Required	C11CK22	7-21
Check Digit Validation	Validate and Transmit One Check Digit	C11CK23	7-22
	Validate and Transmit Two Check Digits	C11CK24	7-22
	Validate and Transmit Auto Select Check Digits	C11CK25	7-22
Code 11 Redundancy	Range (0 - 10) *0	C11VOT##	7-22
Code 11 Message Length	Minimum (1 - 80) *3	C11MIN##	7-23
	Maximum (1 - 80) *80	C11MAX##	7-23
Code 128	Default All Code 128 Settings	128DFT	7-24
	Off	128ENA0	7-24
	*On	128ENA1	7-24
128 Group Separator Output	*Off	128GSE0	7-24
	On	128GSE1	7-24
Code 128 Redundancy	Range (0 - 10) *0	128VOT##	7-25
Code 128 Message Length	Minimum (1 - 80) *3	128MIN##	7-25
	Maximum (1 - 80) *80	128MAX##	7-25
ISBT 128	*Off	ISBENA0	7-25
	On	ISBENA1	7-25
	Concatenation Timeout	DLYCCT	7-26

Selection	Setting <i>* Indicates default</i>	Serial Command <i># Indicates a numeric entry</i>	Page
ISBT128 Predefined Concatenation Sequences	* Donation ID Number (001) and ABO/RhD Blood Groups (002)	ISBPCS0	7-26
	Donation ID Number (001) and Donor ID Number (019)	ISBPCS1	7-26
	Donation ID Number (001) and Confidential Unit Exclusion Status	ISBPCS2	7-26
	Product Code (003) and Expiration Date (Form 1)	ISBPCS3	7-26
	Product Code (003) and Expiration Date (Form 2)	ISBPCS4	7-26
	Product Code (003) and Expiration Date (Form 3)	ISBPCS5	7-26
	Product Code (003) and Expiration Date (Form 4)	ISBPCS6	7-26
ISBT 128 Predefined Concatenation Sequences On/Off	*Off	ISBPCE0	7-27
	Allow Predefined Sequence	ISBPCE1	7-27
	Require Predefined Sequence	ISBPCE2	7-27

Selection	Setting <i>* Indicates default</i>	Serial Command <i># Indicates a numeric entry</i>	Page
ISBT 128 User-Defined Concatenation Sequences	1st Left Identifier (0-255) *0	ISBUL1##	7-28
	2nd Left Identifier (0-255) *0	ISBUL2##	7-28
	1st Right Identifier (0-255) *0	ISBUR1##	7-28
	2nd Right Identifier (0-255) *0	ISBUR2##	7-28
ISBT 128 User-Defined Concatenation Sequences On/Off	*Off	ISBUCE0	7-29
	Allow User-Defined Sequence	ISBUCE1	7-29
	Require User-Defined Sequence	ISBUCE2	7-29
Content Verification	*Off	ISBXM00	7-29
	On	ISBXM01	7-29
Transmit Identifiers	Off	ISBXM10	7-30
	*On	ISBXM11	7-30
Flag Conversion	*Off	ISBXM20	7-30
	On	ISBXM21	7-30
GS1-128	Default All GS1-128 Settings	GS1DFT	7-31
	*On	GS1ENA1	7-31
	Off	GS1ENA0	7-31
GS1-128 Application Identifier Parsing	*Off	GS1EMU0	7-31
	Transmit Without Identifiers	GS1EMU1	7-31
	Transmit With Identifiers	GS1EMU2	7-31
GS1-128 Redundancy	Range (0 - 10) *0	GS1VOT##	7-32
GS1-128 Message Length	Minimum (1 - 80) *3	GS1MIN	7-32
	Maximum (0 - 80) *80	GS1MAX	7-32

Selection	Setting <i>* Indicates default</i>	Serial Command <i># Indicates a numeric entry</i>	Page
Telepen	Default All Telepen Settings	TELDFT	7-33
	*Off	TELENA0	7-33
	On	TELENA1	7-33
Telepen Output	*AIM Telepen Output	TELOLD0	7-33
	Original Telepen Output	TELOLD1	7-33
Telepen Redundancy	Range (0 - 10) *0	TELVOT##	7-34
Telepen Message Length	Minimum (1 - 80) *3	TELMIN##	7-34
	Maximum (1 - 80) *80	TELMAX##	7-34
UPC-A	Default All UPC-A Settings	UPADFT	7-35
	Off	UPAENA0	7-36
	*On	UPAENA1	7-36
UPC-A Number System	Off	UPANSX0	7-35
	*On	UPANSX1	7-35
UPC-A Check Digit	Off	UPACKX0	7-35
	*On	UPACKX1	7-36
UPC-A 2 Digit Addenda	*Off	UPAAD20	7-36
	On	UPAAD21	7-36
UPC-A 5 Digit Addenda	*Off	UPAAD50	7-36
	On	UPAAD51	7-36
UPC-A Addenda Required	*Not Required	UPAARQ0	7-36
	Required	UPAARQ1	7-36
Addenda Timeout	Range (0 - 65535) *100	DLYADD#####	7-37
UPC-A Addenda Separator	*Off	UPAADS0	7-37
	On	UPAADS1	7-37
UPC-A Redundancy	Range (0 - 10) *0	UPAVOT##	7-37

Selection	Setting <i>* Indicates default</i>	Serial Command <i># Indicates a numeric entry</i>	Page
UPC-A/EAN-13 with Extended Coupon Code	*Off	CPNENA0	7-38
	Allow Concatenation	CPNENA1	7-38
	Require Concatenation	CPNENA2	7-38
UPC-A Number System 4 Addenda Required	* Don't Require Coupon Code	ARQSY40	7-39
	Require Coupon Code	ARQSY41	7-39
UPC-A Number System 5 Addenda Required	* Don't Require Coupon Code/ Addenda	ARQSY50	7-40
	Require 2 Digit Addenda	ARQSY51	7-40
	Require 5 Digit Addenda	ARQSY52	7-40
	Require 2 or 5 Digit Addenda	ARQSY53	7-40
	Require Coupon Code	ARQSY54	7-40
	Require Coupon Code or 2 Digit Addenda	ARQSY55	7-40
	Require Coupon Code or 5 Digit Addenda	ARQSY56	7-40
	Require Coupon Code, 2 Digit Addenda, or 5 Digit Addenda	ARQSY57	7-40
Addenda Timeout	Range (0 - 65535) *100	DLYADD#####	7-41
UPC-E0	Default All UPC-E Settings	UPEDFT	7-41
	Off	UPEEN00	7-41
	*On	UPEEN01	7-41

Selection	Setting <i>* Indicates default</i>	Serial Command <i># Indicates a numeric entry</i>	Page
UPC-E0 Expand	*Off	UPEEXP0	7-41
	On	UPEEXP1	7-41
UPC-E0 Number System	*On	UPEEXN1	7-42
	Off	UPEEXN0	7-42
UPC-E0 Check Digit	*Off	UPECKX0	7-42
	On	UPECKX1	7-42
UPC-E0 Leading Zero	*Off	UPENSX0	7-43
	On	UPENSX1	7-43
UPC-E0 Addenda	2 Digit Addenda On	UPEAD21	7-43
	*2 Digit Addenda Off	UPEAD20	7-43
	5 Digit Addenda On	UPEAD51	7-43
	*5 Digit Addenda Off	UPEAD50	7-43
UPC-E0 Addenda Required	Required	UPEARQ1	7-43
	*Not Required	UPEARQ0	7-43
Addenda Timeout	Range (0 - 65535) *100	DLYADD#####	7-44
UPC-E0 Addenda Separator	On	UPEADS1	7-44
	*Off	UPEADS0	7-44
UPC-E0 Redundancy	Range (0 - 10) *1	UPEVOT##	7-44
EAN/JAN-13	Default All EAN/ JAN Settings	E13DFT	7-45
	Off	E13ENA0	7-45
	*On	E13ENA1	7-45
EAN/JAN-13 Check Digit	Off	E13CKX0	7-45
	*On	E13CKX1	7-45
EAN/JAN-13 2 Digit Addenda	2 Digit Addenda On	E13AD21	7-46
	*2 Digit Addenda Off	E13AD20	7-46
	5 Digit Addenda On	E13AD51	7-46
	*5 Digit Addenda Off	E13AD50	7-46
EAN/JAN-13 Addenda Required	*Not Required	E13ARQ0	7-46
	Required	E13ARQ1	7-46

Selection	Setting <i>* Indicates default</i>	Serial Command <i># Indicates a numeric entry</i>	Page
EAN-13 Beginning with 2 Addenda Required	* Don't Require 2 Digit Addenda	ARQSY20	7-47
	Require 2 Digit Addenda	ARQSY21	7-47
EAN-13 Beginning with 290 Addenda Required	* Don't Require 5 Digit Addenda	ARQ2900	7-47
	Require 5 Digit Addenda	ARQ2901	7-47
EAN-13 Beginning with 378/379 Addenda Required	* Don't Require Addenda	ARQ3780	7-48
	Require 2 Digit Addenda	ARQ3781	7-48
	Require 5 Digit Addenda	ARQ3782	7-48
	Require 2 or 5 Digit Addenda	ARQ3783	7-48
EAN-13 Beginning with 414/419 Addenda Required	* Don't Require Addenda	ARQ4140	7-49
	Require 2 Digit Addenda	ARQ4141	7-49
	Require 5 Digit Addenda	ARQ4142	7-49
	Require 2 or 5 Digit Addenda	ARQ4143	7-49
EAN-13 Beginning with 434/439 Addenda Required	* Don't Require Addenda	ARQ4340	7-50
	Require 2 Digit Addenda	ARQ4341	7-50
	Require 5 Digit Addenda	ARQ4342	7-50
	Require 2 or 5 Digit Addenda	ARQ4343	7-50

Selection	Setting <i>* Indicates default</i>	Serial Command <i># Indicates a numeric entry</i>	Page
EAN-13 Beginning with 977 Addenda Required	* Don't Require 2 Digit Addenda	ARQ9770	7-50
	Require 2 Digit Addenda	ARQ9771	7-50
EAN-13 Beginning with 978 Addenda Required	* Don't Require 5 Digit Addenda	ARQ9780	7-51
	Require 5 Digit Addenda	ARQ9781	7-51
EAN-13 Beginning with 979 Addenda Required	* Don't Require 5 Digit Addenda	ARQ9790	7-51
	Require 5 Digit Addenda	ARQ9791	7-51
Addenda Timeout	Range (0 - 65535) *100	DLYADD#####	7-52
EAN/JAN-13 Addenda Separator	*Off	E13ADS0	7-52
	On	E13ADS1	7-53
EAN/JAN-13 Redundancy	Range (0 - 10) *0	E13VOT##	7-52
ISBN Translate	*Off	E13ISB0	7-53
	On	E13ISB1	7-53
	Convert to 13-Digit On	E13I131	7-53
	*Convert to 13-Digit Off	E13I130	7-53
	Reformat On	E13IBR1	7-53
	*Reformat Off	E13IBR0	7-53
ISSN Translate	*Off	E13ISS0	7-54
	On	E13ISS1	7-54
	Reformat On	E13ISR1	7-54
	*Reformat Off	E13ISR0	7-54

Selection	Setting <i>* Indicates default</i>	Serial Command <i># Indicates a numeric entry</i>	Page
EAN/JAN-8	Default All EAN/ JAN 8 Settings	EA8DFT	7-55
	Off	EA8ENA0	7-55
	*On	EA8ENA1	7-55
EAN/JAN-8 Check Digit	Off	EA8CKX0	7-55
	*On	EA8CKX1	7-55
EAN/JAN-8 Addenda	*2 Digit Addenda Off	EA8AD20	7-56
	2 Digit Addenda On	EA8AD21	7-56
	*5 Digit Addenda Off	EA8AD50	7-56
	5 Digit Addenda On	EA8AD51	7-56
EAN/JAN-8 Addenda Required	*Not Required	EA8ARQ0	7-56
	Required	EA8ARQ1	7-56
Addenda Timeout	Range (0 - 65535) *100	DLYADD#####	7-57
EAN/JAN-8 Addenda Separator	*Off	EA8ADS0	7-57
	On	EA8ADS1	7-57
EAN/JAN-8 Redundancy	Range (0 - 10) *0	EA8VOT##	7-57
MSI	Default All MSI Settings	MSIDFT	7-58
	*Off	MSIENA0	7-58
	On	MSIENA1	7-58
MSI Check Character	*Validate Type 10, but Don't Transmit	MSICHK0	7-59
	Validate Type 10 and Transmit	MSICHK1	7-59
	Validate 2 Type 10 Chars, but Don't Transmit	MSICHK2	7-59
	Validate 2 Type 10 Chars and Transmit	MSICHK3	7-59
	Disable MSI Check Characters	MSICHK6	7-59
MSI Redundancy	Range (0 - 10) *0	MSIVOT##	7-59

Selection	Setting <i>* Indicates default</i>	Serial Command <i># Indicates a numeric entry</i>	Page
MSI Message Length	Minimum (1 - 80) *3	MSIMIN##	7-60
	Maximum (1 - 80) *80	MSIMAX##	7-60
Plessey Code	Default All Plessey Code Settings	PLSDFT	7-60
	Off	PLSENA0	7-60
	*On	PLSENA1	7-60
Plessey Check Char.	*No Check Char.	PLSCHK0	7-61
	Validate, But Don't Transmit	PLSCHK1	7-61
	Validate, and Transmit	PLSCHK2	7-61
Plessey Redundancy	Range (0 - 10) *0	PLSVOT##	7-61
Plessey Message Length	Minimum (1 - 80) *3	PLSMIN##	7-61
	Maximum (1 - 80) *80	PLSMAX##	7-61
GS1 DataBar Omnidirectional	Default All GS1 DataBar Omnidirectional Settings	RSSDFT	7-62
	Off	RSSENA0	7-62
	*On	RSSENA1	7-62
GS1 DataBar Omnidirectional Redundancy	Range (0 - 10) *0	RSSVOT##	7-62
GS1 DataBar Limited	Default All GS1 DataBar Limited Settings	RSLDFT	7-63
	Off	RSLENA0	7-63
	*On	RSLENA1	7-63
GS1 DataBar Limited Redundancy	Range (0 - 10) *0	RSLVOT##	7-63

Selection	Setting <i>* Indicates default</i>	Serial Command <i># Indicates a numeric entry</i>	Page
GS1 DataBar Expanded	Default All GS1 DataBar Expanded Settings	RSEDFT	7-64
	Off	RSEENA0	7-64
	*On	RSEENA1	7-64
GS1 DataBar Expanded Redundancy	Range (0 - 10) *0	RSEVOT##	7-64
GS1 DataBar Expanded Msg. Length	Minimum (1 - 80) *3	RSEMIN##	7-65
	Maximum (1 - 80) *80	RSEMAX##	7-65
Trioptic Code	*Off	TRIENA0	7-65
	On	TRIENA1	7-65
GS1 Emulation	GS1-128 Emulation	EANEMU1	7-66
	GS1 DataBar Emulation	EANEMU2	7-66
	GS1 Code Expansion Off	EANEMU3	7-66
	EAN8 to EAN13 Conversion	EANEMU4	7-66
	*GS1 Emulation Off	EANEMU0	7-66
<i>Postal Codes</i>			
China Post (Hong Kong 2 of 5)	Default All China Post (Hong Kong 2 of 5) Settings	CPCDFT	7-66
	*Off	CPCENA0	7-67
	On	CPCENA1	7-67
China Post (Hong Kong 2 of 5) Redundancy	Range (0 - 10) *0	CPCVOT##	7-67
China Post (Hong Kong 2 of 5) Msg. Length	Minimum (1 - 80) *3	CPCMIN##	7-67
	Maximum (1 - 80) *80	CPCMAX##	7-67

Selection	Setting <i>* Indicates default</i>	Serial Command <i># Indicates a numeric entry</i>	Page
<i>Serial Trigger Commands</i>			
Read Time-Out	0 - 300,000 <i>*30,000 ms</i>	TRGSTO####	10-4

Voyager 1200g Product Specifications

Parameter	Specification
Mechanical	
Height	3.8 in. (97mm)
Length	7.1 in. (180mm)
Width	2.6 in. (66mm)
Weight	4.41 oz. (125g)
Electrical	
Input Voltage	5V + 5%
Operating Power	700mW; 140 mA (typical) @ 5V
Standby Power	350mW; 70 mA (typical) @ 5V
Environmental	
Operating Temperature	32°F to 122°F (0°C to 50°C)
Storage Temperature	-4°F to 140°F (-20°C to 60°C)
Humidity	0 to 95% non-condensing
Drop	Operational after 30 drops to concrete from 5 ft. (1.5m)
Environmental Sealing	IP42
Light Levels	0 - 70,000 lux (direct sunlight)
ESD	16kV, 9kV contact
Scan Performance	
Scan Pattern	Single scan line
Scan Angle	Horizontal: 30°
Scan Speed	100 scan lines per second
Print Contrast	10% minimum reflectance difference
Pitch, Skew	60°, 60°
Decode Capabilities	Reads standard 1D and GS1 DataBar symbologies
DOF with 3.5 mil resolution at standard range	
Typical Performance	
5 mil Code 39	27 - 151mm (1.1 - 5.9 in.)
7.5 mil Code 39	16 - 216mm (.6 - 8.5 in.)
10.4 mil Code 39	0 - 277mm (0 - 10.9 in.)
13 mil UPC-A	0 - 311mm (0 - 12.2 in.)
20 mil Code 39	0 - 367mm (0 - 14.4 in.)

Parameter	Specification
Guaranteed Performance	
5 mil Code 39	38 - 132mm (1.5 - 5.2 in.)
7.5 mil Code 39	26 - 189mm (1 - 7.4 in.)
10.4 mil Code 39	0 - 229mm (0 - 9 in.)
13 mil UPC-A	0 - 253mm (0 - 10 in.)
20 mil Code 39	0 - 293mm (0 - 11.5 in.)
Laser Beam	
Wavelength	645 - 660 nm
Divergence	< 1.5 mrad. per IEC 60825-1 worst case
Maximum Power Output	< 1 mw
Embedded Laser	
Wavelength	645 - 660 nm
Divergence	< 1.5 mrad. per IEC 60825-1 worst case
Maximum Power Output	10 mw

Voyager 1202g Product Specifications

Parameter	Specification
Mechanical	
Height	3.6 in. (92mm)
Length	7.1 in. (180mm)
Width	2.6 in. (66mm)
Weight (includes battery)	6.3 oz. (180g)
Battery	
Lithium Ion	1800 mAHr minimum
Number of Scans	Up to 45,000 per charge
Expected Hours of Operation	12
Expected Charge Time	4 hours (external supply) 8 hours (USB power)
Radio	
Frequency	2.4 to 2.5 GHz (ISM Band) Frequency Hopping Bluetooth v.2.1
Range	33 ft. (10 m) typical line of sight
Data Rate	Up to 3 MBps
Environmental	
Temperature Ranges: Operating - Charging Operating - Non-Charging Storage* Humidity	41° F to +104° F (5° C to 40° C) 32° F to +122° F (0° C to 50° C) 23°F to +95°F (-5°C to 35°C) 0 to 95% relative humidity, non-condensing
Mechanical Drop	Designed to withstand 30 drops from 5 feet (1.5m) to concrete
Environmental Sealing	IP42
ESD Sensitivity	16kV air 9kV contact
Scan Performance	
Pitch, Skew	60°, 60°

Parameter	Specification
Scan Pattern	Single scan line
Scan Angle	Horizontal: 30°
Scan Speed	100 scan lines per second
Print Contrast	10% minimum reflectance difference
Decode Capabilities	Reads standard 1D and GS1 DataBar symbologies
DOF with 3.5 mil resolution at standard range	
Typical Performance	
5 mil Code 39	27 - 151mm (1.1 - 5.9 in.)
7.5 mil Code 39	16 - 216mm (.6 - 8.5 in.)
1.40 mil Code 39	0 - 277mm (0 - 10.9 in.)
13 mil UPC-A	0 - 311mm (0 - 12.2 in.)
20 mil Code 39	0 - 367mm (0 - 14.4 in.)
Guaranteed Performance	
5 mil Code 39	38 - 132mm (1.5 - 5.2 in.)
7.5 mil Code 39	26 - 189mm (1 - 7.4 in.)
10.4 mil Code 39	0 - 229mm (0 - 9 in.)
13 mil UPC-A	0 - 253mm (0 - 10 in.)
20 mil Code 39	0 - 293mm (0 - 11.5 in.)
Laser Beam	
Wavelength	645 - 660 nm
Divergence	< 1.5 mrad. per IEC 60825-1 worst case
Maximum Power Output	< 1 mw
Embedded Laser	
Wavelength	645 - 660 nm
Divergence	< 1.5 mrad. per IEC 60825-1 worst case
Maximum Power Output	10 mw

CCB00-010BT Product Specifications

Parameter	Specification
Mechanical	
Dimensions (Typical):	
Height	3.8 inches (97mm)
Length	7.9 inches (200mm)
Width	2.6 inches (67mm)
Weight	6.5 oz (185g)

Electrical	
Input Voltage	5 volts \pm 5%
Operating Power - Charging	5W (1A@5V) (external supply) 2.5W (0.5A@5V) (USB power)
Non-Charging Power	0.625W (0.125A@5V)
Expected Charge Time	4 hours (external supply) 8 hours (USB power)
Radio	
Frequency	2.4 to 2.5 GHz (ISM Band) Frequency Hopping Bluetooth v.2.1
Range	33 ft. (10 m) typical (line of sight)
Data Rate	Up to 3 MBps
Temperature Ranges:	
Operating - Charging	41° F to +104° F (5° C to 40° C)
Operating - Non-Charging	32° F to +122° F (0° C to 50° C)
Storage*	23°F to +95°F (-5°C to 35°C)
Humidity	0 to 95% relative humidity, non-condensing
Environmental	
Mechanical Drop	Operational after 30 drops from 3.28 feet (1m) to concrete
ESD Sensitivity	16kV air 9kV contact

CCB00-010BT Mounting

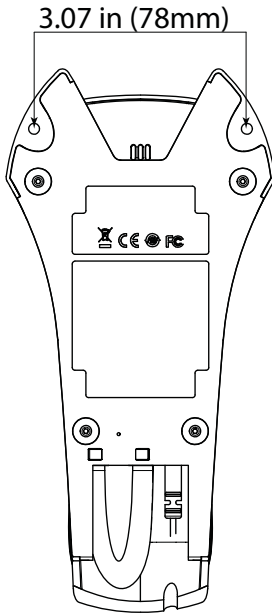

Use 2 M3x15mm
PHP, self-tapping
wood screws

Standard Cable Pinouts

Keyboard Wedge

10 Pin RJ41 Modular Plug
connects to the base

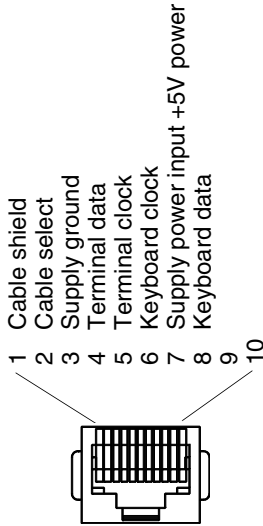

Note: Pin assignments are not compatible with Honeywell legacy products.
Use of a cable with improper pin assignments may lead to damage to the unit.
Use of any cables not provided by the manufacturer may result in damage not covered by your warranty.

Standard Cable Pinouts

Serial Output

10 Pin RJ41 Modular Plug
connects to the base

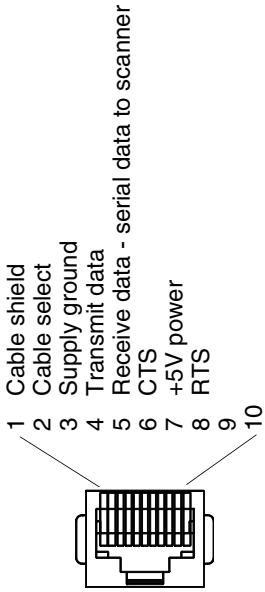

*Note: Pin assignments are not compatible with Honeywell legacy products.
Use of a cable with improper pin assignments may lead to damage to the unit.
Use of any cables not provided by the manufacturer may result in damage not covered by your warranty.*

Standard Cable Pinouts

RS485 Output

10 Pin RJ41 Modular Plug
connects to the base

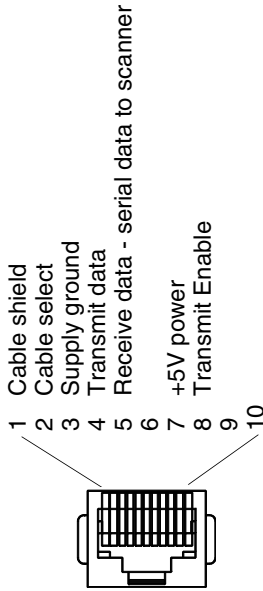

Note: RS485 signal conversion is performed in the cable.
Pin assignments are not compatible with Honeywell legacy products.
Use of a cable with improper pin assignments may lead to damage to the unit.
Use of any cables not provided by the manufacturer may result in damage not covered by your warranty.

Standard Cable Pinouts

USB

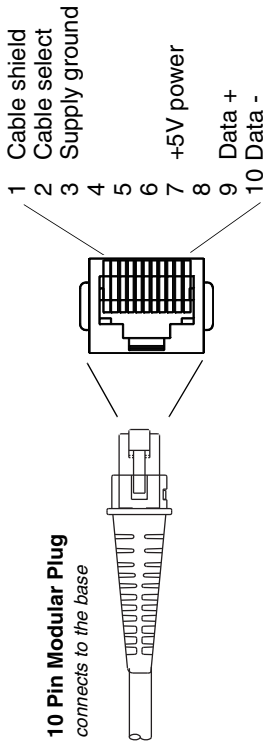

*Note: Pin assignments are not compatible with Honeywell legacy products.
Use of a cable with improper pin assignments may lead to damage to the unit.
Use of any cables not provided by the manufacturer may result in damage not covered by your warranty.*

Repairs

Repairs and/or upgrades are not to be performed on this product. These services are to be performed only by an authorized service center (see [Customer Support](#) on page 13-1).

Maintenance

Your device provides reliable and efficient operation with a minimum of care. Although specific maintenance is not required, the following periodic checks ensure dependable operation:

Cleaning the Device

Reading performance may degrade if the scanner's window is not clean. If the window is visibly dirty, or if the scanner isn't operating well, clean the window with a soft cloth or lens tissue dampened with water (or a mild detergent- water solution). If a detergent solution is used, rinse with a clean lens tissue dampened with water only.

The scanner and base's housing may also be cleaned the same way.



Caution:

Do not submerge the scanner in water. The scanner's housing is not watertight.

Do not use abrasive wipes or tissues on the scanner's window – abrasive wipes may scratch the window. Never use solvents (e.g., alcohol or acetone) on the housing or window – solvents may damage the finish or the window.

Inspecting Cords and Connectors

Inspect the interface cable and connector for wear or other signs of damage. A badly worn cable or damaged connector may interfere with scanner operation. Contact your distributor for information about cable replacement. Cable replacement instructions are on [page 12-1](#).

Replacing Cables in Corded Scanners

The standard interface cable is attached to the scanner with an 10-pin modular connector. When properly seated, the connector is held in the scanner's handle by a flexible retention tab. The interface cable is designed to be field replaceable.

-
- Order replacement cables from Honeywell or from an authorized distributor.
 - When ordering a replacement cable, specify the cable part number of the original interface cable.

Replacing an Interface Cable in a Corded Scanner

1. Turn the power to the host system OFF.
2. Disconnect the scanner's cable from the terminal or computer.
3. Locate the small hole on the underside of the scanner's handle. This is the cable release.
4. Straighten one end of a paper clip.
5. Insert the end of the paper clip into the small hole and press in. This depresses the retention tab, releasing the connector. Pull the connector out while maintaining pressure on the paper clip, then remove the paper clip.
6. Replace with the new cable.
Insert the connector into the opening and press firmly. The connector is keyed to go in only one way, and will click into place.

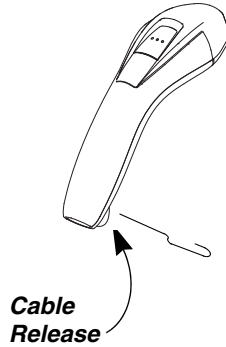

Replacing Cables in Cordless Systems

Replacing an Interface Cable in a Base

1. Turn the power to the host system OFF.
2. Disconnect the base's cable from the terminal or computer.

3. Turn the base upside down.
4. Locate the pinhole for the cable release and insert a straightened paper clip.
5. Pull the connector out while maintaining pressure on the connector release clip.

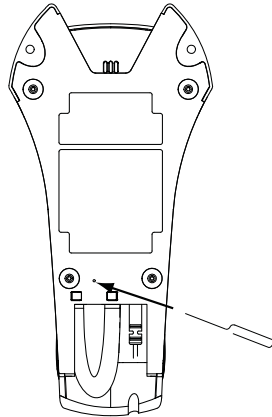

6. Replace with the new cable. Insert the connector into the opening and press firmly. The connector is keyed to go in only one way, and will click into place.

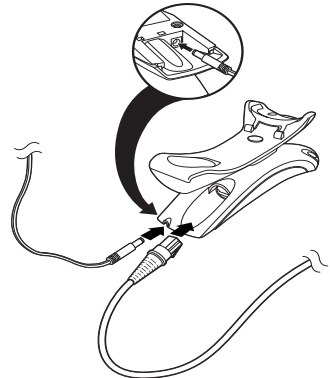

Troubleshooting a Voyager Scanner

The scanner automatically performs self-tests whenever you turn it on. If your scanner is not functioning properly, review the following Troubleshooting Guide to try to isolate the problem.

Is the power on? Is the laser aimer on?

If the laser aimer isn't illuminated, check that:

- The cable is connected properly.
- The host system power is on (if external power isn't used).
- The button works.

Is the scanner having trouble reading your symbols?

If the scanner isn't reading symbols well, check that the scanner window is clean and that the symbols:

- Aren't smeared, rough, scratched, or exhibiting voids.
- Aren't coated with frost or water droplets on the surface.
- Are enabled in the scanner or in the decoder to which the scanner connects.

Is the bar code displayed but not entered?

The bar code is displayed on the host device correctly, but you still have to press a key to enter it (the Enter/Return key or the Tab key, for example).

- You need to program a suffix. Programming a suffix enables the scanner to output the bar code data plus the key you need (such as “CR”) to enter the data into your application. Refer to [Prefix/Suffix Overview](#) on page 5-1 for further information.

Does the scanner read the bar code incorrectly?

If the scanner reads a bar code, but the data is not displayed correctly on the host screen:

- The scanner may not be programmed for the appropriate terminal interface.
For example, you scan “12345” and the host displays “@es%.”

Reprogram the scanner with the correct Plug and Play bar code. See [Programming the Interface](#) beginning on page 2-1.

- The scanner may not be programmed to output your bar code data properly.
For example, you scan “12345” and the host displays “A12345B.”

Reprogram the scanner with the proper symbology selections. See [Chapter 7](#).

The scanner won't read your bar code at all.

1. Scan the sample bar codes in the back of this manual. If the scanner reads the sample bar codes, check that your bar code is readable. Verify that your bar code symbology is enabled (see [Chapter 7](#)).
2. If the scanner still can't read the sample bar codes, scan [All Symbologies On](#), page 7-1.

The cordless scanner won't scan bar codes while it is in the base.

1. Scanning While in Cradle Off may be programmed.
2. Scan the * [Scanning in Cradle On](#) (page 3-8) bar code so the scanner will also scan bar codes while in the base.

If you aren't sure what programming options have been set in the scanner, or if you want the factory default settings restored, refer to [Setting Custom Defaults](#) on page 1-8.

Troubleshooting a Cordless System

Troubleshooting a Base

Note: Visit the Services and Support section of our website (www.honeywellaidc.com) to check for the latest software for both the scanner and the base.

If your base is not functioning properly, review the following troubleshooting guidelines to try to isolate the problem.

Is the red LED on?

If the red LED isn't illuminated, check that:

- The power cable is connected properly and there is power at the power source.
- The host system power is on (if external power isn't used).

Is the green LED on?

If the *green* LED isn't illuminated, check that:

- The scanner is correctly placed in the base.
- There is external power or 12 volt host power.
- Charge mode is turned on. (See "[Flash Updates](#)" on page 3-6)
- The battery is not bad or deeply discharged. In some cases, the scanner's battery may trickle charge to bring it into an acceptable level and then transition to a normal charge cycle.

Troubleshooting a Cordless Scanner

Note: Make sure that your scanner's battery is charged. Visit the Services and Support section of our website (www.honeywellaidc.com) to check for the latest software for both the scanner and the base or Access Point.

Is the scanner having trouble reading your symbols?

If the scanner isn't reading symbols well, check that the symbols:

- Aren't smeared, rough, scratched, or exhibiting voids.
- Aren't coated with frost or water droplets on the surface.
- Are enabled in the base or Access Point to which the scanner connects.

Is the bar code displayed but not entered into the application?

The bar code is displayed on the host device correctly, but you still have to press a key to enter it (the Enter/Return key or the Tab key, for example).

- You need to program a suffix. Programming a suffix enables the scanner to output the bar code data plus the key you need (such as "CR") to enter the data into your application. Refer to [Prefix/Suffix Overview](#) on page 5-1 for further information.

Does the scanner read the bar code incorrectly?

If the scanner reads a bar code, but the data is not displayed correctly on the host screen:

- The base or Access Point may not be programmed for the appropriate terminal interface. For example, you scan "12345" and the host displays "@es%."

Reprogram the base/Access Point with the correct Plug and Play bar code. See [Programming the Interface](#) beginning on page 2-1.

-
- The base or Access Point may not be programmed to output your bar code data properly. For example, you scan “12345” and the host displays “A12345B.”

Reprogram the base/Access Point with the proper symbology selections. See [Chapter 7](#).

The scanner won't read your bar code at all.

- Scan the sample bar codes in the back of this manual. If the scanner reads the sample bar codes, check that your bar code is readable.

Verify that your bar code symbology is enabled (see [Chapter 7](#)).

If the scanner still can't read the sample bar codes, scan [All Symbologies](#) on page 7-1.

Technical Assistance

If you need assistance installing or troubleshooting your device, please contact us by using one of the methods below:

Knowledge Base: www.hsmknowledgebase.com

Our Knowledge Base provides thousands of immediate solutions. If the Knowledge Base cannot help, our Technical Support Portal (see below) provides an easy way to report your problem or ask your question.

Technical Support Portal: www.hsmsupportportal.com

The Technical Support Portal not only allows you to report your problem, but it also provides immediate solutions to your technical issues by searching our Knowledge Base. With the Portal, you can submit and track your questions online and send and receive attachments.

Web form: www.hsmcontactsupport.com

You can contact our technical support team directly by filling out our online support form. Enter your contact details and the description of the question/problem.

Telephone: www.honeywellaidc.com/locations

For our latest contact information, please check our website at the link above.

Product Service and Repair

Honeywell International Inc. provides service for all its products through service centers throughout the world. To obtain warranty or non-warranty service, contact the appropriate location below to obtain a Return Material Authorization number (RMA #) before returning the product.

North America

Telephone: (800) 782-4263

E-mail: hsmnaservice@honeywell.com

Latin America

Telephone: (803) 835-8000

Telephone: (800) 782-4263

Fax: (239) 263-9689

E-mail: laservice@honeywell.com

Brazil

Telephone: +55 (11) 5185-8222

Fax: +55 (11) 5185-8225

E-mail: brservice@honeywell.com

Mexico

Telephone: 01-800-HONEYWELL (01-800-466-3993)

Fax: +52 (55) 5531-3672

E-mail: mxservice@honeywell.com

Europe, Middle East, and Africa

Telephone: +31 (0) 40 2901 633

Fax: +31 (0) 40 2901 631

E-mail: euroservice@honeywell.com

Hong Kong

Telephone: +852-29536436

Fax: +852-2511-3557

E-mail: apservice@honeywell.com

Singapore

Telephone: +65-6842-7155

Fax: +65-6842-7166

E-mail: apservice@honeywell.com

China

Telephone: +86 800 828 2803

Fax: +86-512-6762-2560

E-mail: apservice@honeywell.com

Japan

Telephone: +81-3-6730-7344

Fax: +81-3-6730-7222

E-mail: apservice@honeywell.com

Online Product Service and Repair Assistance

You can also access product service and repair assistance online at www.honeywellaidc.com.

Limited Warranty

Honeywell International Inc. ("HII") warrants its products to be free from defects in materials and workmanship and to conform to HII's published specifications applicable to the products purchased at the time of shipment. This warranty does not cover any HII product which is (i) improperly installed or used; (ii) damaged by accident or negligence, including failure to follow the proper maintenance, service, and cleaning schedule; or (iii) damaged as a result of (A) modification or alteration by the purchaser or other party, (B) excessive voltage or current supplied to or drawn from the interface connections, (C) static electricity or electro-static discharge, (D) operation under conditions beyond the specified operating parameters, or (E) repair or service of the product by anyone other than HII or its authorized representatives.

This warranty shall extend from the time of shipment for the duration published by HII for the product at the time of purchase ("Warranty Period"). Any defective product must be returned (at purchaser's expense) during the Warranty Period to HII factory or authorized service center for inspection. No product will be accepted by HII without a Return Materials Authorization, which may be obtained by contacting HII. In the event that the product is returned to HII or its authorized service center within the Warranty Period and HII determines to its satisfaction that the product is defective due to defects in materials or workmanship, HII, at its sole option, will either repair or replace the product without charge, except for return shipping to HII.

EXCEPT AS MAY BE OTHERWISE PROVIDED BY APPLICABLE LAW, THE FOREGOING WARRANTY IS IN LIEU OF ALL OTHER COVENANTS OR WARRANTIES, EITHER EXPRESSED OR IMPLIED, ORAL OR WRITTEN, INCLUDING, WITHOUT LIMITATION, ANY IMPLIED WARRANTIES OF MERCHANTABILITY OR FITNESS FOR A PARTICULAR PURPOSE, OR NON-INFRINGEMENT.

HII'S RESPONSIBILITY AND PURCHASER'S EXCLUSIVE REMEDY UNDER THIS WARRANTY IS LIMITED TO THE REPAIR OR REPLACEMENT OF THE DEFECTIVE PRODUCT WITH NEW OR REFURBISHED PARTS. IN NO EVENT SHALL HII BE LIABLE FOR INDIRECT, INCIDENTAL, OR CONSEQUENTIAL DAMAGES, AND, IN NO EVENT, SHALL ANY LIABILITY OF HII ARISING IN CONNECTION WITH ANY PRODUCT SOLD HEREUNDER (WHETHER SUCH LIABILITY ARISES FROM A CLAIM BASED ON CONTRACT, WARRANTY, TORT, OR OTHERWISE) EXCEED THE ACTUAL AMOUNT PAID TO HII FOR THE PRODUCT. THESE LIMITATIONS ON LIABILITY SHALL REMAIN IN FULL FORCE AND EFFECT EVEN WHEN HII MAY HAVE BEEN ADVISED OF THE POSSIBILITY OF SUCH INJURIES, LOSSES, OR DAMAGES. SOME STATES, PROVINCES, OR COUNTRIES DO NOT ALLOW THE EXCLUSION OR LIMITATIONS OF INCIDENTAL OR CONSEQUENTIAL DAMAGES, SO THE ABOVE LIMITATION OR EXCLUSION MAY NOT APPLY TO YOU.

All provisions of this Limited Warranty are separate and severable, which means that if any provision is held invalid and unenforceable, such determination shall not affect the validity of enforceability of the other provisions hereof. Use of any peripherals not provided by the manufacturer may result in damage not covered by this warranty. This includes but is not limited to: cables, power supplies, bases, and docking stations. HII extends these warranties only to the first end-users of the products. These warranties are non-transferable.

The duration of the limited warranty for the Voyager 1200g scanner is five (5) years.

The duration of the limited warranty for the Voyager 1202g scanner and CCB00-010BT Charge Base is three (3) years.

The duration of the limited warranty for the Voyager battery is one (1) year.



Symbology Chart

Note: Not all symbologies may be supported by your device.

Symbology	AIM ID	Possible AIM ID Modifiers (m)	Code ID (hex)
All Symbologies			(0x99)
Australian Post]X0		A (0x41)
Aztec Code]zm	0-9, A-C	z (0x7A)
British Post]X0		B (0x42)
Canadian Post]X0		C (0x43)
China Post]X0		Q (0x51)
Chinese Sensible Code (Han Xin Code)]X0		H (0x48)
Codabar]Fm	0-1	a (0x61)
Codablock A]O6	0, 1, 4, 5, 6	V (0x56)
Codablock F]Om	0, 1, 4, 5, 6	q (0x71)
Code 11]H3		h (0x68)
Code 128]Cm	0, 1, 2, 4	j (0x6A)
GS1-128]C1		l (0x49)
Code 32 Pharmaceutical (PARAF)]X0		< (0x3C)
Code 39 (supports Full ASCII mode)]Am	0, 1, 3, 4, 5, 7	b (0x62)
Code 49]Tm	0, 1, 2, 4	l (0x6C)
Code 93 and 93i]Gm	0-9, A-Z, a-m	i (0x69)
Data Matrix]dm	0-6	w (0x77)
EAN-13 (including Bookland EAN)]E0		d (0x64)
EAN-13 with Add-On]E3		d (0x64)
EAN-13 with Extended Coupon Code]E3		d (0x64)

Symbology	AIM ID	Possible AIM ID Modifiers (m)	Code ID (hex)
EAN-8]E4		D (0x44)
EAN-8 with Add-On]E3		D (0x44)
GS1 Composite]em	0-3	y (0x79)
GS1 DataBar]em	0	y (0x79)
GS1 DataBar Limited]em		{ (0x7B)
GS1 DataBar Omnidirectional]em		y (0x79)
GS1 DataBar Expanded]em		} (0x7D)
InfoMail]X0		, (0x2c)
Intelligent Mail Bar Code]X0		M (0x4D)
Interleaved 2 of 5]lm	0, 1, 3	e (0x65)
Japanese Post]X0		J (0x4A)
KIX (Netherlands) Post]X0		K (0x4B)
Korea Post]X0		? (0x3F)
Matrix 2 of 5]X0		m (0x6D)
MaxiCode]Um	0-3	x (0x7 8)
MicroPDF417]Lm	3-5	R (0x52)
MSI]Mm	0	g (0x67)
NEC 2 of 5]X0		Y (0x59)
OCR MICR (E 13 B)]o3		O (0x4F)
OCR SEMI Font]o3		O (0x4F)
OCR-A]o1		O (0x4F)
OCR-B]o2		O (0x4F)
PDF417]Lm	0-2	r (0x72)
Planet Code]X0		L (0x4C)
Postal-4i]X0		N (0x4E)
Postnet]X0		P (0x50)
QR Code and Micro QR Code]Qm	0-6	s (0x73)
Straight 2 of 5 IATA]Rm	0, 1, 3	f (0x66)

Symbology	AIM ID	Possible AIM ID Modifiers (m)	Code ID (hex)
Straight 2 of 5 Industrial]S0		f (0x66)
TCIF Linked Code 39 (TLC39)]L2		T (0x54)
Telepen]Bm		t (0x54)
UPC-A]E0		c (0x63)
UPC-A with Add-On]E3		c (0x63)
UPC-A with Extended Coupon Code]E3		c (0x63)
UPC-E]E0		E (0x45)
UPC-E with Add-On]E3		E (0x45)
UPC-E1]X0		E (0x45)

Note: “m” represents the AIM modifier character. Refer to International Technical Specification, Symbology Identifiers, for AIM modifier character details.

Prefix/Suffix entries for specific symbologies override the universal (All Symbologies, 99) entry.

Refer to [Data Editing](#) beginning on page 5-1 and [Data Formatting](#) beginning on page 6-1 for information about using Code ID and AIM ID.

ASCII Conversion Chart (Code Page 1252)

Note: This table applies to U.S. style keyboards. Certain characters may differ depending on your Country Code/PC regional settings.

Non-Printable Characters					
DEC	HEX	Character (Code)	DEC	HEX	Character (Code)
0	0	NULL	16	10	DATA LINK ESCAPE (DLE)
1	1	START OF HEADING (SOH)	17	11	DEVICE CONTROL 1 (DC1)
2	2	START OF TEXT (STX)	18	12	DEVICE CONTROL 2 (DC2)
3	3	END OF TEXT (ETX)	19	13	DEVICE CONTROL 3 (DC3)
4	4	END OF TRANSMISSION (EOT)	20	14	DEVICE CONTROL 4 (DC4)
5	5	END OF QUERY (ENQ)	21	15	NEGATIVE ACKNOWLEDGEMENT (NAK)
6	6	ACKNOWLEDGE (ACK)	22	16	SYNCHRONIZE (SYN)
7	7	BEEP (BEL)	23	17	END OF TRANSMISSION BLOCK (ETB)
8	8	BACKSPACE (BS)	24	18	CANCEL (CAN)
9	9	HORIZONTAL TAB (HT)	25	19	END OF MEDIUM (EM)
10	A	LINE FEED (LF)	26	1A	SUBSTITUTE (SUB)
11	B	VERTICAL TAB (VT)	27	1B	ESCAPE (ESC)
12	C	FF (FORM FEED)	28	1C	FILE SEPARATOR (FS) RIGHT ARROW
13	D	CR (CARRIAGE RETURN)	29	1D	GROUP SEPARATOR (GS) LEFT ARROW
14	E	SO (SHIFT OUT)	30	1E	RECORD SEPARATOR (RS) UP ARROW
15	F	SI (SHIFT IN)	31	1F	UNIT SEPARATOR (US) DOWN ARROW

Printable Characters								
DEC	HEX	Character	DEC	HEX	Character	DEC	HEX	Character
32	20	<SPACE>	64	40	@	96	60	`
33	21	!	65	41	A	97	61	a
34	22	"	66	42	B	98	62	b
35	23	#	67	43	C	99	63	c
36	24	\$	68	44	D	100	64	d
37	25	%	69	45	E	101	65	e
38	26	&	70	46	F	102	66	f
39	27	'	71	47	G	103	67	g

Printable Characters (Continued)								
DEC	HEX	Character	DEC	HEX	Character	DEC	HEX	Character
40	28	(72	48	H	104	68	h
41	29)	73	49	I	105	69	i
42	2A	*	74	4A	J	106	6A	j
43	2B	+	75	4B	K	107	6B	k
44	2C	,	76	4C	L	108	6C	l
45	2D	-	77	4D	M	109	6D	m
46	2E	.	78	4E	N	110	6E	n
47	2F	/	79	4F	O	111	6F	o
48	30	0	80	50	P	112	70	p
49	31	1	81	51	Q	113	71	q
50	32	2	82	52	R	114	72	r
51	33	3	83	53	S	115	73	s
52	34	4	84	54	T	116	74	t
53	35	5	85	55	U	117	75	u
54	36	6	86	56	V	118	76	v
55	37	7	87	57	W	119	77	w
56	38	8	88	58	X	120	78	x
57	39	9	89	59	Y	121	79	y
58	3A	:	90	5A	Z	122	7A	z
59	3B	;	91	5B	[123	7B	{
60	3C	<	92	5C	\	124	7C	
61	3D	=	93	5D]	125	7D	}
62	3E	>	94	5E	^	126	7E	~
63	3F	?	95	5F	_	127	7F	

Extended ASCII Characters								
DEC	HEX	Character	DEC	HEX	Character	DEC	HEX	Character
128	80	€	171	AB	«	214	D6	Ö
129	81		172	AC	¬	215	D7	×
130	82	,	173	AD		216	D8	Ø
131	83	f	174	AE	®	217	D9	Ù
132	84	„	175	AF	¯	218	DA	Ú
133	85	...	176	B0	°	219	DB	Û
134	86	†	177	B1	±	220	DC	Ü
135	87	‡	178	B2	²	221	DD	Ý
136	88	^	179	B3	³	222	DE	Þ
137	89	‰	180	B4	´	223	DF	ß
138	8A	Š	181	B5	µ	224	E0	à
139	8B	<	182	B6	¶	225	E1	á

Extended ASCII Characters (Continued)								
DEC	HEX	Character	DEC	HEX	Character	DEC	HEX	Character
140	8C	Œ	183	B7	·	226	E2	â
141	8D		184	B8	¸	227	E3	ã
142	8E	Ž	185	B9	¹	228	E4	ä
143	8F		186	BA	º	229	E5	å
144	90		187	BB	»	230	E6	æ
145	91	‘	188	BC	¼	231	E7	ç
146	92	’	189	BD	½	232	E8	è
147	93	“	190	BE	¾	233	E9	é
148	94	”	191	BF	¿	234	EA	ê
149	95	•	192	C0	À	235	EB	ë
150	96	–	193	C1	Á	236	EC	ì
151	97	—	194	C2	Â	237	ED	í
152	98	˜	195	C3	Ã	238	EE	î
153	99	™	196	C4	Ä	239	EF	ï
154	9A	š	197	C5	Å	240	F0	ð
155	9B	›	198	C6	Æ	241	F1	ñ
156	9C	œ	199	C7	Ç	242	F2	ò
157	9D		200	C8	È	243	F3	ó
158	9E	ž	201	C9	É	244	F4	ô
159	9F	ÿ	202	CA	Ê	245	F5	õ
160	A0		203	CB	Ë	246	F6	ö
161	A1	ı	204	CC	Ì	247	F7	÷
162	A2	ç	205	CD	Í	248	F8	ø
163	A3	£	206	CE	Î	249	F9	ù
164	A4	κ	207	CF	Ï	250	FA	ú
165	A5	¥	208	D0	Ð	251	FB	û
166	A6	ı	209	D1	Ñ	252	FC	ü
167	A7	§	210	D2	Ò	253	FD	ý
168	A8	”	211	D3	Ó	254	FE	þ
169	A9	©	212	D4	Ô	255	FF	ÿ
170	AA	ª	213	D5	Õ			

Code Page Mapping of Printed Barcodes

Code pages define the mapping of character codes to characters. If the data received does not display with the proper characters, it may be because the barcode being scanned was created using a code page that is different from

the one the host program is expecting. If this is the case, select the code page with which the barcodes were created. The data characters should then appear properly.

Note: The Code Page option is available for Code 39, Code 93, and Code 128.

Code Page	Standard	Description
1	CP ISO646	
2 (Default)	ISO 2022	Automatic National Replacement Characters
3	CP Binary	
51	ISO 8859 1 51	Western European Replacement Characters
82	ISO 2022 11 Swe	Swedish Replacement Characters
83	ISO 2022 69 Fra	French/Belgium Replacement Characters
81	ISO 2022 25 Fra	French/Belgium Replacement Characters
84	ISO 2022 11 Ger	German Replacement Characters
85	ISO 2022 11 Ita	Italian Replacement Characters
86	ISO 2022 11 Swi	Swiss Replacement Characters
87	ISO 2022 11 UK	British Replacement Characters
88	ISO 2022 11 Dan	Danish Replacement Characters
89	ISO 2022 11 Nor	Norwegian Replacement Characters
90	ISO 2022 11 Spa	Spanish Replacement Characters
91	ISO 2022 85	Spanish Replacement Characters
92	ISO 2022 16	Portuguese Replacement Characters
93	ISO 2022 84	Portuguese Replacement Characters
94	ISO 2022 60	Norwegian Replacement Characters



Sample Symbols

UPC-A



0 123456 7890

Interleaved 2 of 5

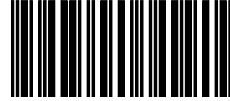

1234567890

Code 128



Code 128

EAN-13



9 780330 290951

Code 39

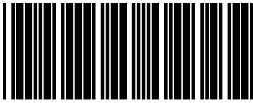

BC321

Codabar

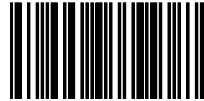

A13579B

Code 93



123456-9\$

Straight 2 of 5 Industrial

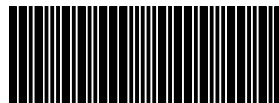

123456

Sample Symbols

Matrix 2 of 5



6543210

GS1 DataBar



(01)00123456789012

Programming Chart



K0K
0



K2K
2



K4K
4



K6K
6



K8K
8



K1K
1



K3K
3



K5K
5



K7K
7



K9K
9

Programming Chart



KAK
A



KCK
C



KEK
E



MNUSAV.
Save



RESET_
Reset



KBK
B



KDK
D



KFK
F



MNUABT.
Discard

*Note: If you make an error while scanning the letters or digits (before scanning Save), scan Discard, scan the correct letters or digits, and **Save** again.*

Honeywell Scanning & Mobility

9680 Old Bailes Road
Fort Mill, SC 29707