

Customer Display  
**DM-D110**

Installation Manual / 設置マニュアル / 安裝手冊

## CAUTIONS

- ❑ This document shall apply only to the product(s) identified herein.
- ❑ No part of this document may be reproduced, stored in a retrieval system, or transmitted in any form or by any means, electronic, mechanical, photocopying, recording, or otherwise, without the prior written permission of Seiko Epson Corporation.
- ❑ The contents of this document are subject to change without notice. Please contact us for the latest information.
- ❑ While every precaution has been taken in the preparation of this document, Seiko Epson Corporation assumes no responsibility for errors or omissions.
- ❑ Neither is any liability assumed for damages resulting from the use of the information contained herein.
- ❑ Neither Seiko Epson Corporation nor its affiliates shall be liable to the purchaser of this product or third parties for damages, losses, costs, or expenses incurred by the purchaser or third parties as a result of: accident, misuse, or abuse of this product or unauthorized modifications, repairs, or alterations to this product, or (excluding the U.S.) failure to strictly comply with Seiko Epson Corporation's operating and maintenance instructions.
- ❑ Seiko Epson Corporation shall not be liable against any damages or problems arising from the use of any options or any consumable products other than those designated as Original EPSON Products or EPSON Approved Products by Seiko Epson Corporation.

## TRADEMARKS

EPSON<sup>®</sup> is a registered trademark of Seiko Epson Corporation.

Microsoft<sup>®</sup>, MS<sup>®</sup>, MS-DOS<sup>®</sup>, Windows<sup>®</sup>, Windows NT<sup>®</sup> are registered trademarks of Microsoft Corporation.

General Notice: Other product and company names used herein are for identification purposes only and may be trademarks of their respective companies.

Copyright © 2000 by SEIKO EPSON CORPORATION

## Safety Precautions

This document presents important information intended to ensure safe and effective use of this product. Please read this document carefully, and store it in an accessible location near your installation.

### Precaution Headings

This document uses the two headings shown below to call attention to potential hazards. Failure to observe the information provided under or alongside these headings may lead to injury or property damage. Be sure that you understand the meaning of each heading before you proceed.



#### **WARNING:**

*Indicates a potentially lethal hazard. Failure to observe a WARNING may result in severe injury or death.*



#### **CAUTION:**

*Failure to observe a CAUTION may result in personal injury, or in damage to equipment or other property.*

### Safety Precautions



#### **WARNING:**

- Shut down your equipment immediately if it produces smoke, a strange odor, or unusual noise. Continued use may lead to fire or electric shock. Immediately turn the power off and contact your dealer or a SEIKO EPSON service center for advice.*
- Never attempt to repair this product yourself. Improper repair work can be dangerous. Tampering with this product may result in injury, fire, or electric shock.*
- Be sure to use the specified power source. Connection to an improper power source may cause fire or shock.*
- Do not allow foreign matter to fall into the equipment. Penetration of foreign objects may lead to fire or shock.*
- If water or other liquid spills into this equipment, immediately turn the power off and contact your dealer or a SEIKO EPSON service center for advice. Continued usage may lead to fire or shock.*

## **CAUTION:**

- Do not plug the cable differently from the instruction in this manual. Wrong connection may cause equipment damage and fire.
- Be sure to set this equipment on a firm, stable, horizontal surface. Product may be damaged or cause injury if it falls.
- Do not use in locations subject to high humidity or dust levels. Excessive humidity and dust may cause equipment damage, fire, or shock.
- Do not place heavy objects on top of this product. Equipment may be damaged and cause injury if it falls.
- Do not attach plural extension supports. Product may be damaged or cause injury if it falls.
- A stopper limits the horizontal rotation of the display. Do not try to force it to turn beyond the limits of the stopper. Doing so may damage the equipment.

## **EMC and Safety Standards Applied**

Product Name: DM-D110

Type Name: M58DB

The following standards are applied only to the display that is so labeled. (EMC is tested using the EPSON PS-170 power supply.)

- Europe: CE Marking  
Safety: EN60950
- North America: EMI: FCC/ICES-003 Class A  
Safety: UL 1950/CSA C22.2 No.950
- Japan: EMC: VCCI Class A JEIDA-52
- Oceania: EMC: AS/NZS 3548 (CISPR22) Class B

## **CE Marking**

The display conforms to the following Directives and Norms

- |                      |   |
|----------------------|---|
| Directive 89/336/EEC | EN55022 Class B<br>EN55024<br>IEC 61000-4-2<br>IEC 61000-4-3<br>IEC 61000-4-4<br>IEC 61000-4-5<br>IEC 61000-4-6<br>IEC 61000-4-11 |
|----------------------|---|

## WARNING

You are cautioned that changes or modifications not expressly approved by SEIKO EPSON Corporation could void your authority to operate the equipment.

### FCC COMPLIANCE STATEMENT FOR AMERICAN USERS

This equipment has been tested and found to comply with the limits for a Class A digital device, pursuant to Part 15 of the FCC Rules. These limits are designed to provide reasonable protection against harmful interference when the equipment is operated in a commercial environment.

This equipment generates, uses, and can radiate radio frequency energy and, if not installed and used in accordance with the instruction manual, may cause harmful interference to radio communications. Operation of this equipment in a residential area is likely to cause harmful interference in which case the user will be required to correct the interference at his own expense.

### FOR CANADIAN USERS

This Class A digital apparatus complies with Canadian ICES-003.

Cet appareil numérique de la classe A est conforme à la norme NMB-003 du Canada.

## About This Manual

### Cautions and Notes



#### **CAUTION:**

*Cautions must be observed to avoid minor injury to yourself or damage to your equipment.*



#### **Note:**

*Notes have important information and useful tips on the operation of your display.*

# Contents

About This Manual .....	3
Contents .....	4
Unpacking .....	5
Cautions on Handling .....	5
Usage .....	6
Assembling .....	7
Attaching to the IM series .....	7
Attaching to the TM-H5000II/TM-J8000 .....	9
Attaching to the TM-U375/TM-U950 .....	12
Attaching to the TM-H6000/TM-U675 .....	15
Attaching to Other TM Printers .....	20
Attaching to the DM-D stand .....	23
Part Names and Functions .....	31
Exterior .....	31
DIP Switch .....	32
DIP Switch Functions .....	32
Turning and Tilting the DM-D110 .....	34
Self Test .....	35
Check Items of Self test .....	35
Performing Self test .....	35
Diagnostics .....	35
Specification .....	36
General Specifications .....	36
Electrical Specifications .....	38
Environmental Specifications .....	38
Character Specifications .....	39
Reliability Specification .....	39

This manual explains how to set up the DM-D110.

## Unpacking

The following items are in the box.

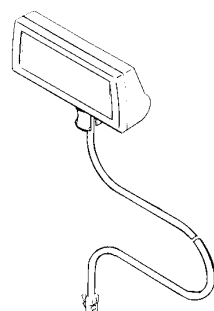

Display (DM-D110)



installation manual

Make sure that you have all the items shown above, and that none has been damaged. If you find anything missing or damaged items, please contact your DM-D110 dealer.

## Cautions on Handling

When you use the DM-D110, be sure to note the following points:

- Avoid locations that are subject to high temperature and humidity.
- Avoid dirty and dusty locations.
- Avoid locations that are unstable or are subject to high levels of vibration.
- When connecting or disconnecting cables, make sure that the power switch of the DM-D110 and printers connected to the DM-D110 are turned off.
- Do not drop the DM-D110, because you may damage the built-in vacuum fluorescent display.

## Usage

The DM-D110 can be used with the following equipment.

- ❑ **IM series.** You can attach the DM-D110 to the IM series using the “DM-D pole unit for IR” (DP-504). (See page 7.)
- ❑ **TM-H5000II/TM-J8000 printers.** You can attach the DM-D110 to TM-H5000II/TM-J8000 printers using the “DM-D pole unit for TM printers (Type B)” (DP-503). (See page 9.)
- ❑ **TM-U375/TM-U950.** You can attach the DM-D110 to the TM-U375/TM-U950 printers using the “DM-D pole unit for TM printers (Type A)” (DP-502). (See page 12.)
- ❑ **TM-H6000/TM-U675.** You can attach the DM-D110 to TM-H6000/TM-U675 printers using the “DM-D pole unit for TM printers (Type A)” (DP-502). (See page 15.)
- ❑ **Other TM printers.** You can attach the DM-D110 using the “DM-D pole unit for TM printers (Type A)” (DP-502) and Velcro tapes or screws. (See page 20.)
- ❑ **DM-D stand.** You can attach the DM-D110 to the DM-D stand directly using the “DM-D stand unit for DM Customer Display” (DP-110). When using the DM-D stand, an optional power supply unit (PS-170) is required. Also, if you want to extend the length of the DM-D110, an optional extension support unit (DP-105) is required. (See page 23.)



## Assembling

### Attaching to the IM series

The DM-D110 can be attached directly to the IM series using the “DM-D pole unit for IR” (DP-504).

### Required items

The following items are used to attach the DM-D110 to the IM series. These items are packed with the “DM-D pole unit for IR” (DP-504).

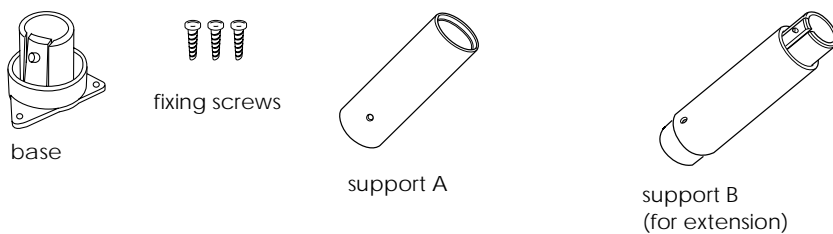

### Assembling steps

1. Pass the cable for the DM-D110 through support A, and attach support A to the DM-D110.  
When using support B for extension, insert the tab on support B into the hole on support A until you feel it click.

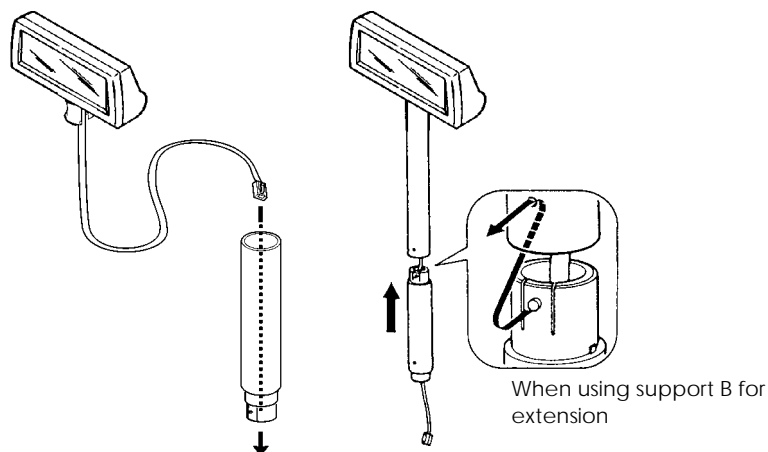

2. Attach the base to the setting position on the IM series, and secure it with the screws.



**Note:**

*When attaching the base, note that the corners of the base are set as shown below.*

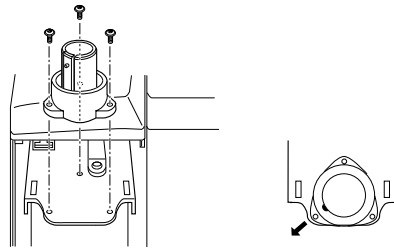

3. Pass the cable for the DM-D110 through the base.

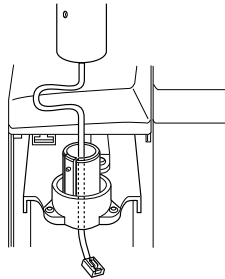

4. Insert the tab on the base into the hole on the support until you feel it click.

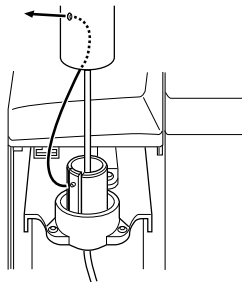

5. Connect the cable for the DM-D110 to the DM connector on the IM series.

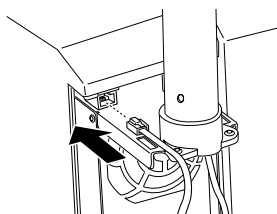

### ***Attaching to the TM-H5000II/TM-J8000***

The DM-D110 can be attached directly to the TM-H5000II/TM-J8000 printers using the “DM-D pole unit for TM printers (Type B)” (DP-503).

#### ***Required items***

The following items are used to attach the DM-D110 to the TM-H5000II/TM-J8000 printers. These items are packed with the “DM-D pole unit for TM printers (Type B)” (DP-503).

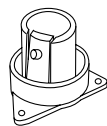

base

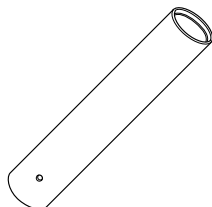

support C



fixing screws

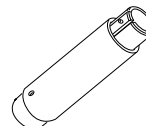

support B  
(for extension)

### Assembling steps

1. Pass the cable for the DM-D110 through support C, and attach support C to the DM-D110.  
When using support B for extension, insert the tab on support B into the hole on support C until you feel it click.

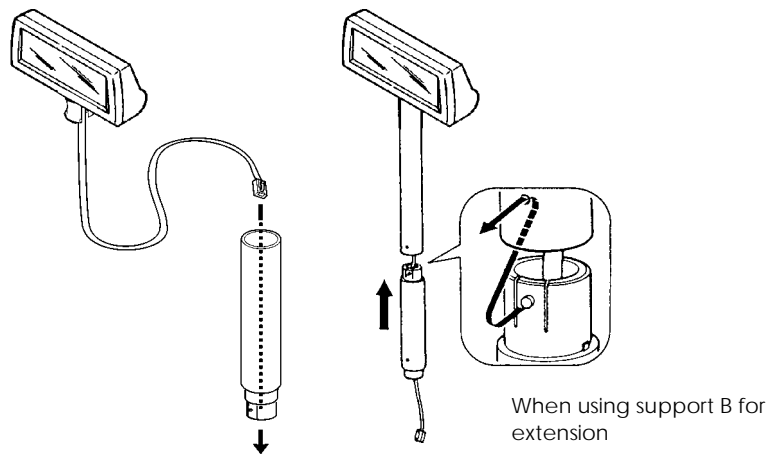

2. Attach the base to the setting position on the TM printer and secure it with the screws.

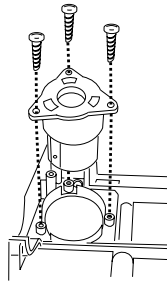

3. Pass the cable for the DM-D110 through the base.

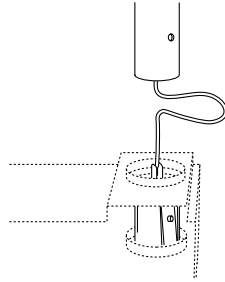

4. Insert the tab on the base into the hole on the support until you feel it click.

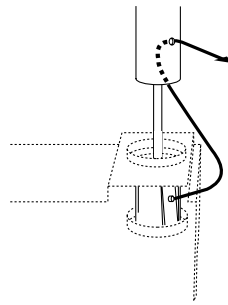

5. Connect the cable for the DM-D110 to the DM connector on the TM printer.

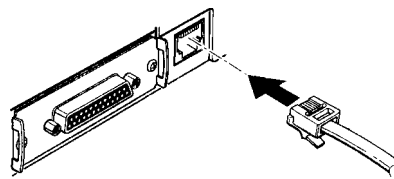

## Attaching to the TM-U375/TM-U950

The DM-D110 can be attached directly to the TM-U375/TM-U950 printers using the “DM-D pole unit for TM printers (Type A)” (DP-502).

### Required items

The following items are used to attach the DM-D110 to the TM-U375/TM-U950 printers. These items are packed with the “DM-D pole unit for TM printers (Type A)” (DP-502).

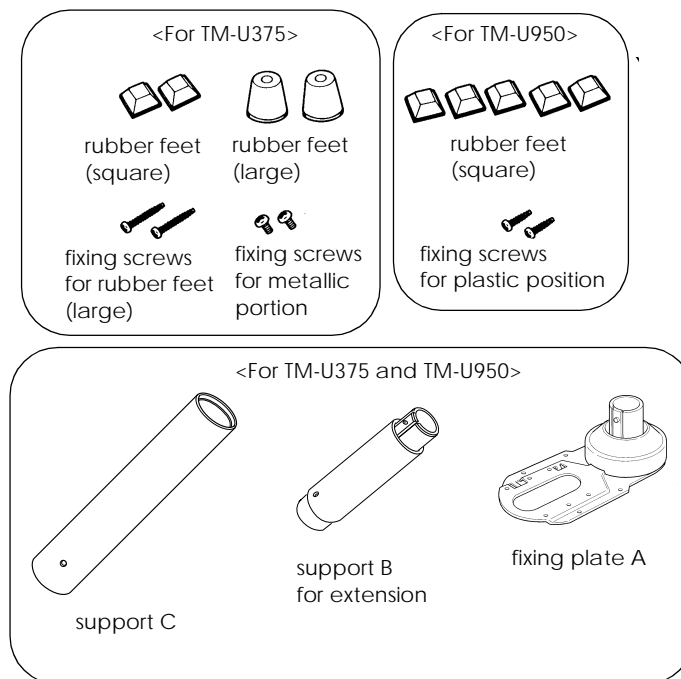

### Assembling steps

1. Pass the cable for the DM-D110 through support C, and attach support C to the DM-D110.  
When using support B for extension, insert the tab on support B into the hole on support C until you feel it click.

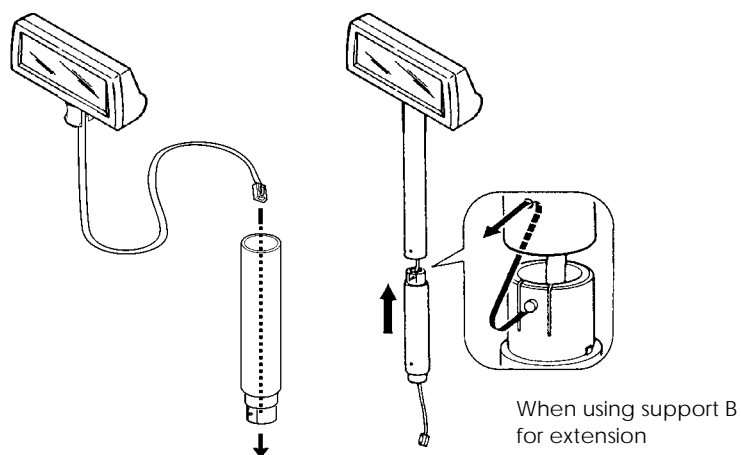

2. Attach the rubber feet to the printer.

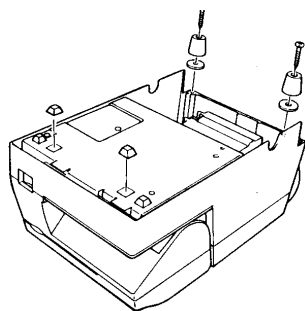

[TM-U375]

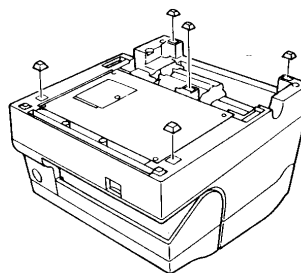

[TM-U950]

3. Pass the cable for the DM-D110 through the hole on fixing plate A, and fix the cable at the bottom as shown below.

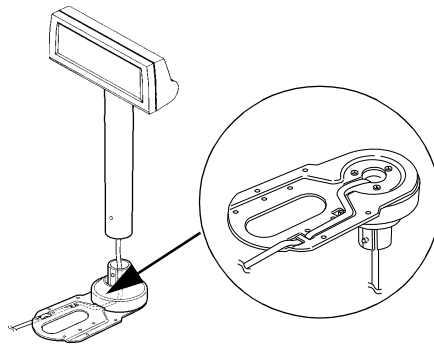

4. Connect the cable for the DM-D110 to the DM connector on the TM printer.

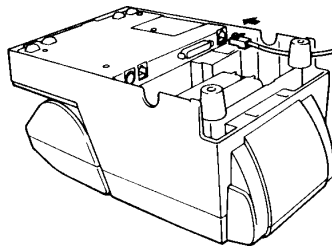

5. Adjust the length of the cable and secure fixing plate A to the printer with screws.

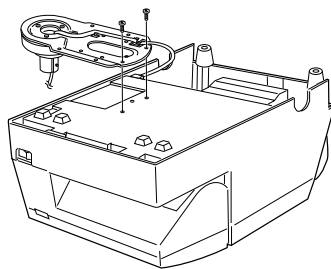

[TM-U375]

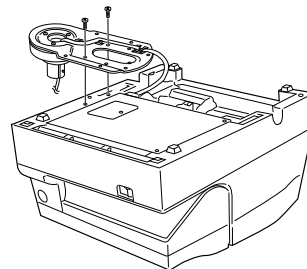

[TM-U950]



6. Store any excess cable in the support, and attach the DM-D110 to fixing plate A.

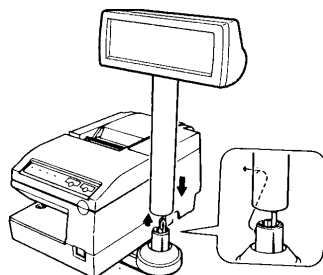

### Attaching to the TM-H6000/TM-U675

The DM-D110 can be attached directly to the TM-H6000/TM-U675 printers using the “DM-D pole unit for TM printers (Type A)” (DP-502). You can attach fixing plate A on either side of the TM-H6000/TM-U675. After attaching it, you can slide the display freely.

### Required items

The following items are used to attach the DM-D110 to the TM-H6000/TM-U675 printers. These items are packed with the “DM-D pole unit for TM printers (Type A)” (DP-502).

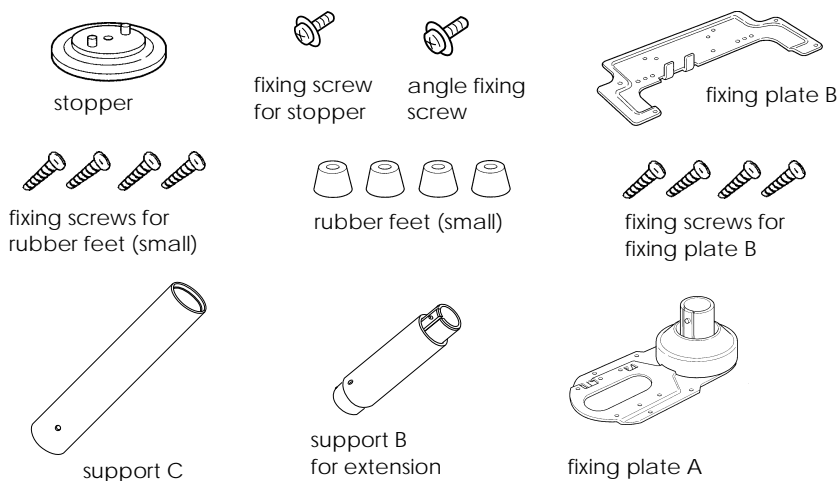

### Assembling steps

1. Pass the cable for the DM-D110 through support C, and attach support C to the DM-D110.  
When using support B for extension, insert the tab on support B into the hole on support C until you feel it click.

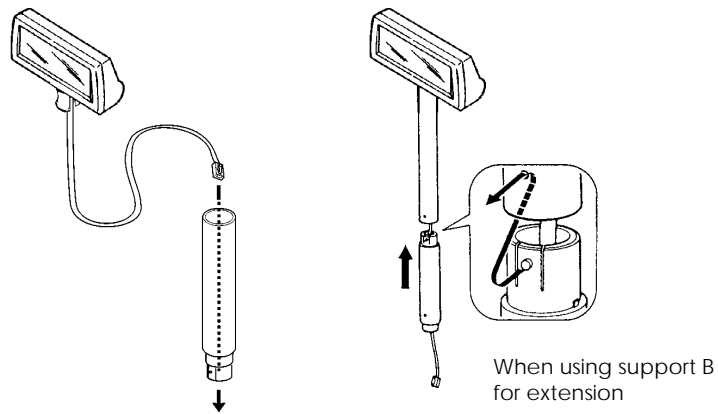

2. Attach the rubber feet to the printer.

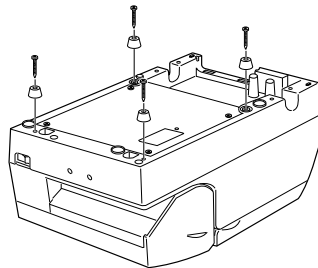

3. Attach fixing plate B to the printer.

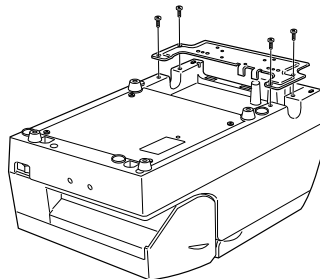

4. Pass the cable for the DM-D110 through the hole on fixing plate A, and fix the cable at the bottom as shown below.

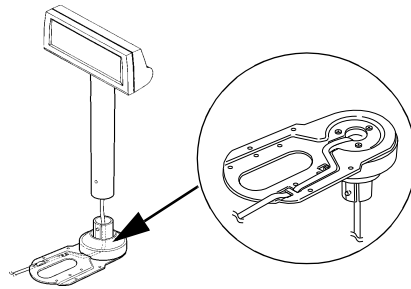

5. Connect the cable for the DM-D110 to the DM connector on the TM printer.

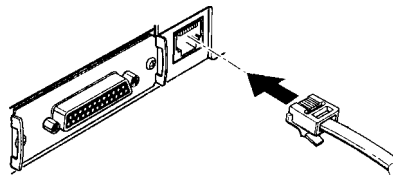

6. Attach fixing plate A to the TM printer using the stopper. When you attach the stopper, insert the projections on the stopper into the holes of fixing plate B. Fixing plate A can be attached on either side of the printer. (The illustration below shows fixing plate A attached to the right side of the printer.)

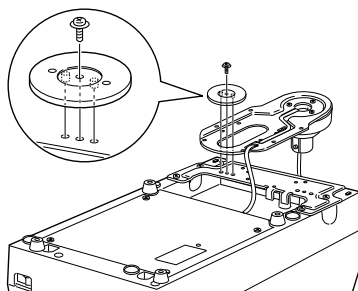

7. The horizontal rotation mechanism of fixing plate A can be adjusted. To secure the location of the display, set fixing plate A to either one of the following four positions and secure it with the angle fixing screw.

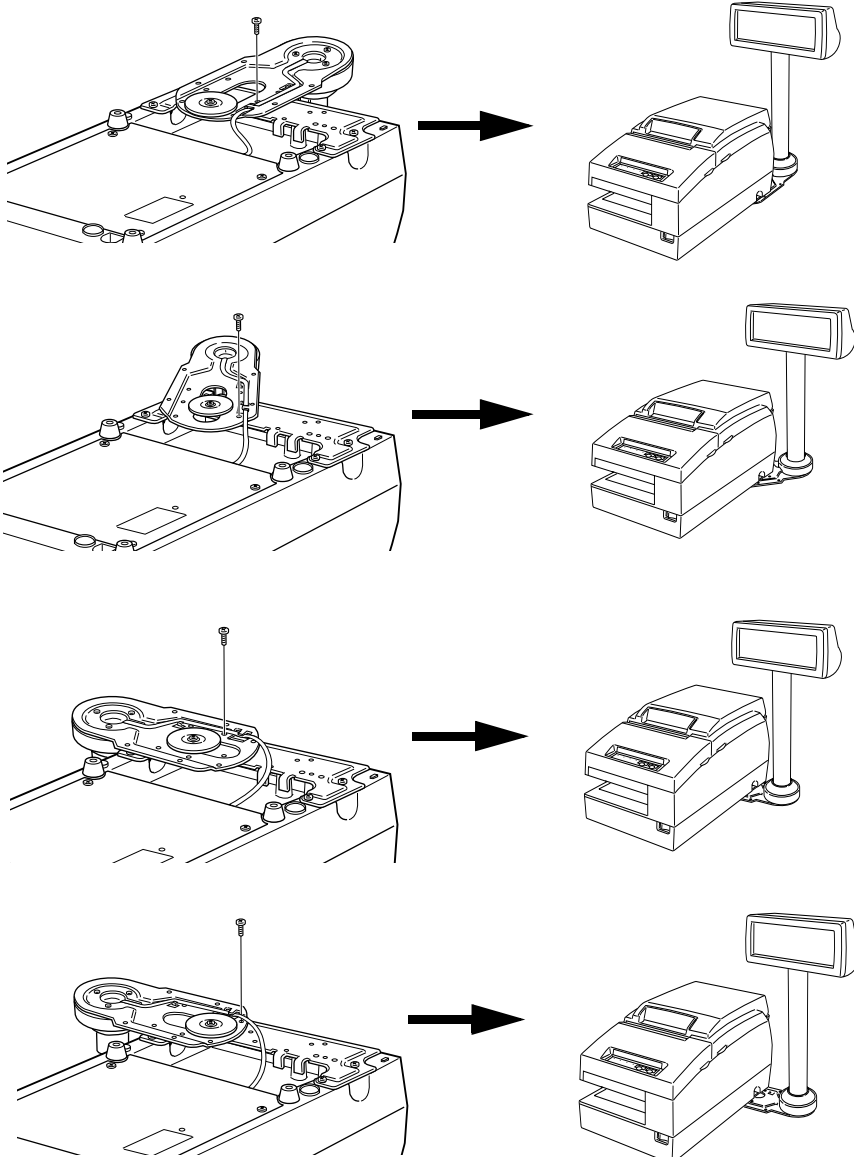

**Note:**

*The paper roll cover may not open if the position of the display is inappropriate. Before securing the position of the display, make sure that you can open the paper roll cover.*

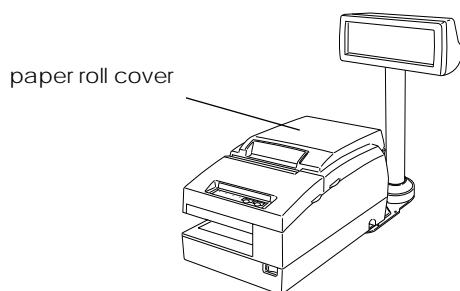

8. Store any excess cable in the support and attach the DM-D110 to fixing plate A.

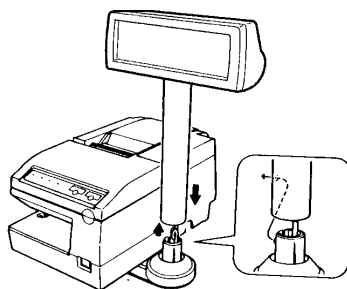

9. Connect the power cable of the printer. To avoid disconnection, hook the cable to the tabs on fixing plate B, as shown below.

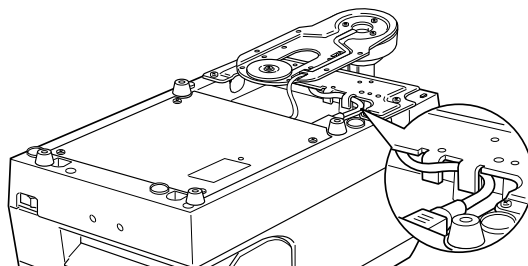

## Attaching to Other TM Printers

When using with other TM printers, the DM-D110 can be attached to a desk or other surface, using the “DM-D pole unit for TM printers (Type A)” (DP-502), and Velcro tapes or screws.

### Required items

The following items are used when the DM-D110 is used with other TM printers. These items are packed with the “DM-D pole unit for TM printers (Type A)” (DP-502).

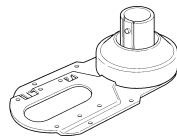

fixing plate A

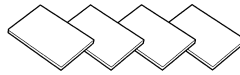

Velcro tapes



Velcro tapes



fixing screws for  
wood position

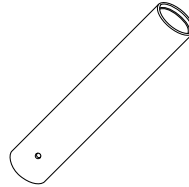

support C

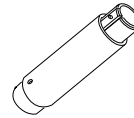

support B (for extension)

### Assembling steps using Velcro tapes

1. Attach Velcro tapes to the bottom of fixing plate A.

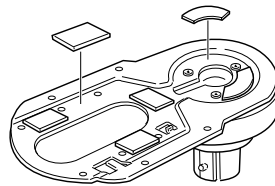

2. Pass the cable for the DM-D110 through support C, and attach support C to the DM-D110.  
When using support B for extension, insert the tab on support B into the hole on support C until you feel it click.

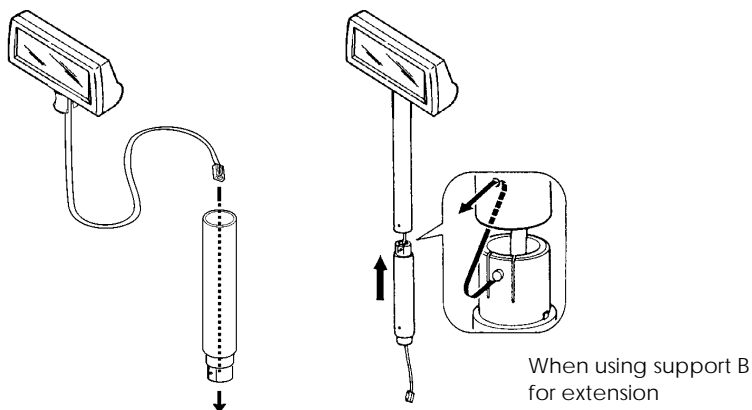

3. Pass the cable for the DM-D110 through the hole on fixing plate A, and fix the cable at the bottom as shown below.

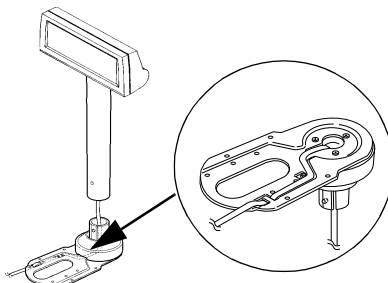

4. Connect the cable for the DM-D110 to the DC connector on the TM printer.

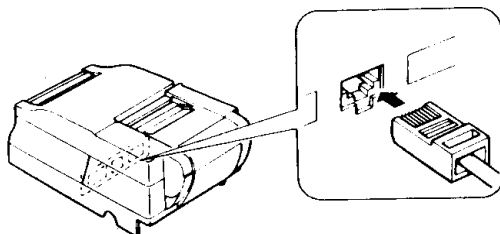

5. Store any excess cable in the support, and attach the DM-D110 to fixing plate A.

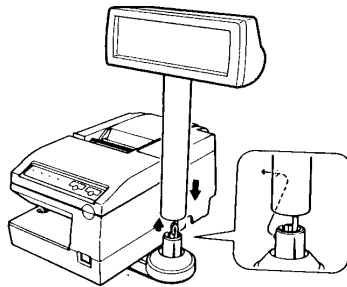

6. Peel off the Velcro tapes, and attach the display to the setting position.

***Assembling steps using screws***

1. Follow steps 2 and 3 in “Assembling steps using Velcro tapes.”
2. Secure fixing plate A to the setting position with fixing screws.

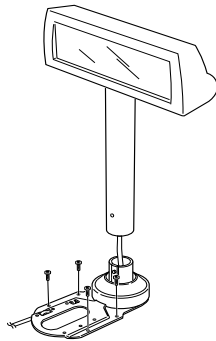

3. Attach the DM-D110 to fixing plate A.



## Attaching to the DM-D stand

The DM-D110 can be attached directly to the DM-D stand using the “DM-D stand unit for DM Customer Display” (DP-110). The DM-D110 with the DM-D stand can be connected to a TM printer, or be used as a stand alone product.

### Required items

The following items are used to attach the DM-D110 to the DM-D stand. Note that an optional power unit (PS-170) is required when using the DM-D stand. If you want to extend the length of the DM-D110. Please get them separately from the DM-D stand unit (DP-501).

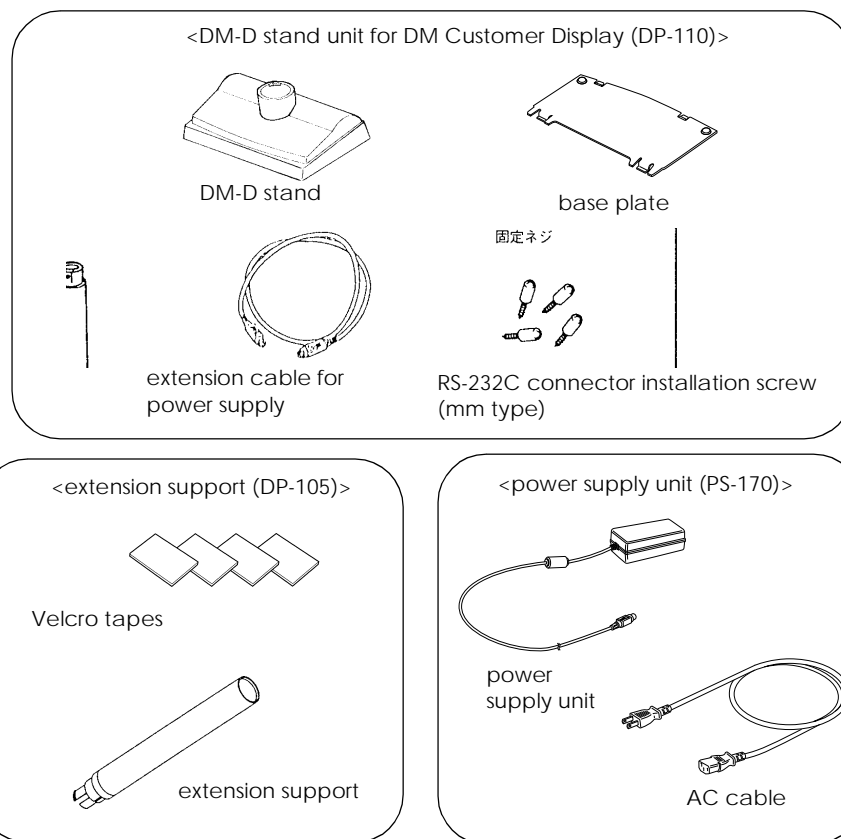

## Connectors for the DM-D stand

The connectors for the DM-D stand are as follows:

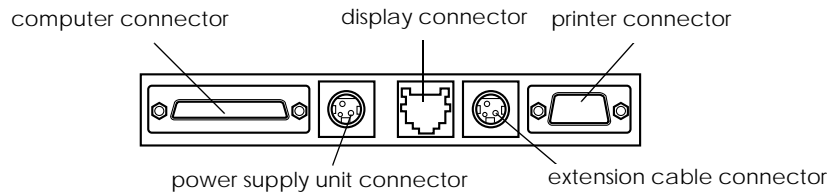

### Note:

The DM-D stand comes with inch-type hexagonal lock screws installed to secure the interface cable to the interface connector for RS-232. If you plan to use an interface cable which requires millimeter-type lock screws, replace the inch-type screws with the included millimeter-type screws using a hex screwdriver (5mm). To distinguish the two types of screws, see the illustration below.

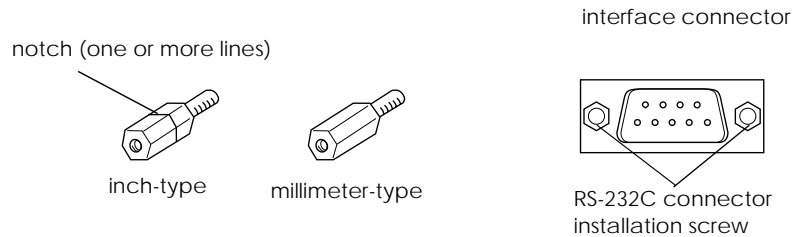

### *Jumper setting*

Set the jumpers on the DM-D stand as follows:

JP1	JP2	Contents
1-2	1-2	Set the jumpers as in the left columns when connecting both the TM printer and the DM-D stand. (Default setting)
2-3	2-3	Set the jumpers as in the left column when using the DM-D stand as stand alone. (TM printer is not connected.)

The jumpers are located as follows:

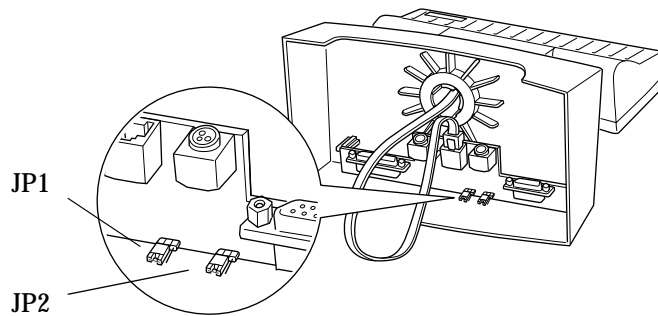

### *Precautions on using the power supply unit*

To avoid damage to the DM-D110 and the power supply unit, make sure to note the following points.

- ❑ Use the optional Seiko Epson products, PS-170, or PA-6508, PA-6511, PA-6513, PB-6509 or PB-6510 as the power supply.
- ❑ Never connect the DC cable to the power supply unit when the power supply unit is connected.
- ❑ Unplug the DC cable by holding the connector part. If you pull the cable to unplug, it may be damaged.

### *Assembling steps*

1. Pass the cable for the DM-D110 through the DM-D stand.  
When extending the length of the DM-D stand, attach the extension support (DP-105) to the DM-D stand.

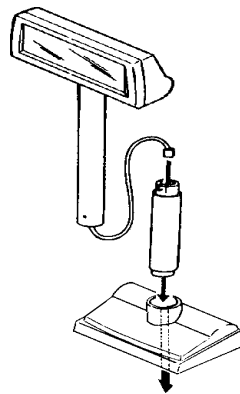
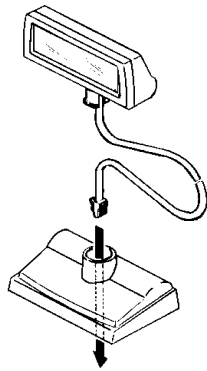

When using the extension support (DP-105)

2. Insert the tab on the DM-D110 (or the extension support) into the hole on the DM-D stand until you feel it click.

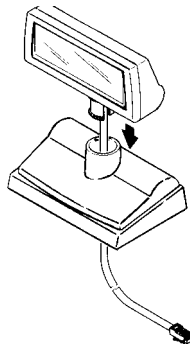

3. Connect the cable for the DM-D110 to the display connector on the DM-D stand until you feel it click.

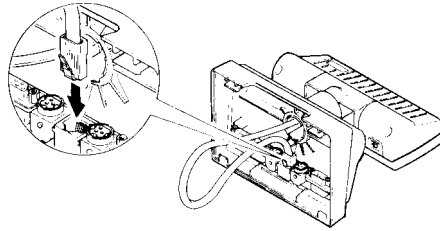

4. Connect one end of the computer interface cable to the computer connector on the DM-D stand; then connect the other end to the RS-232 connector on the computer. Tighten the screws on both ends of the cables to fasten them.

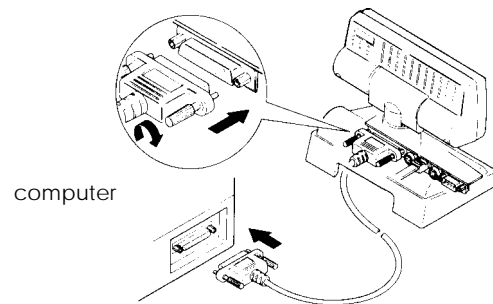

5. When using as a stand alone, go to step 6.  
When using with the printer, connect one end of the printer interface cable for the printer to the printer connector on the DM-D stand; then connect the other end to the connector on the printer. Tighten the screws on both ends of the cable to fasten them.

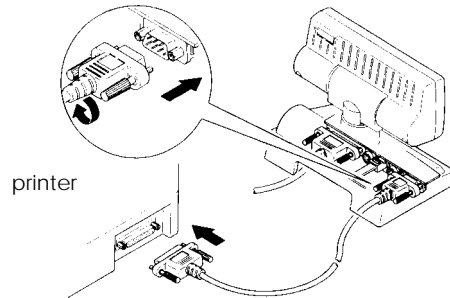

6. When not using the extension cable for power supply packed with the DM-D stand, go to step 7.  
When using the extension cable, connect it (with the arrow mark up) to the extension cable connector indicated with "POWER OUT" on the DM-D stand; then connect the other end to the power connector on the printer.

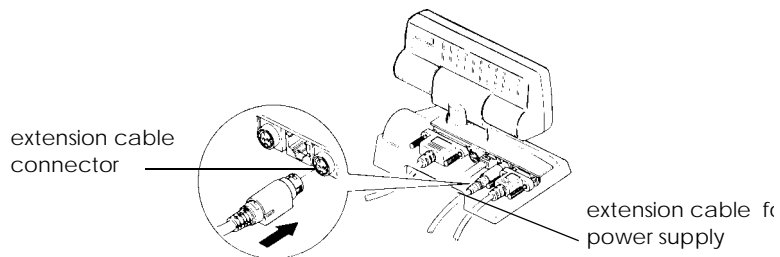

7. Connect the DC cable of the power supply unit (with the arrow mark up) to the power supply unit connector indicated with "POWER IN" on the DM-D stand.

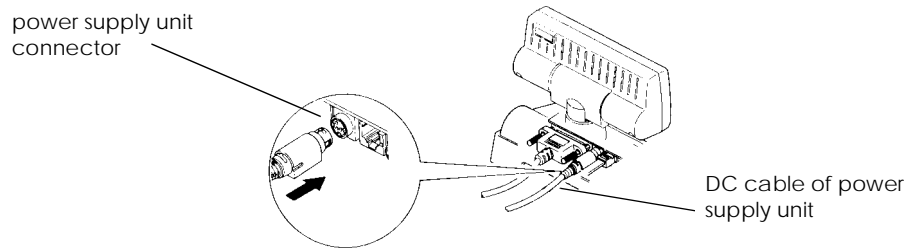

8. When using as a stand alone product, set the jumpers. (See "Jumper setting" on page 25.)
9. Arrange the cables as shown below. Put the cables for the DM-D110 inside the DM-D stand.

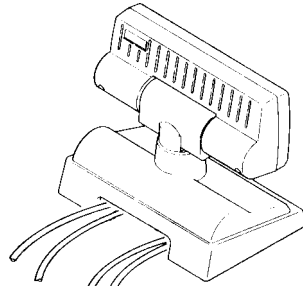

10. Attach the base plate to the DM-D stand following the number of the arrow shown below. At this time, push the base plate until it is locked by the hook on the DM-D stand.

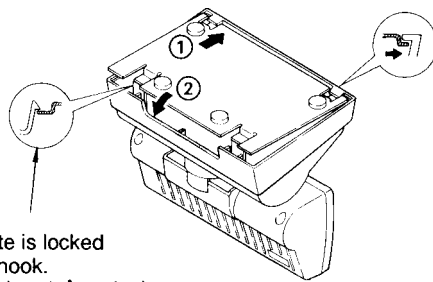

The plate is locked  
by the hook.  
フックによってプレートが  
固定された状態

11. When the extension support (DP-105) is used, attach Velcro tapes to the four corners of the plate to avoid falling down.
12. Connect the cord of the power unit to the socket.



---

## Part Names and Functions

### Exterior

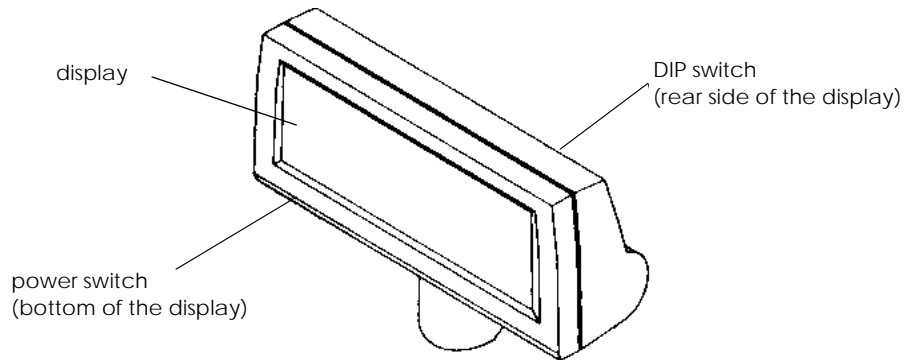

- Display: Characters are displayed.
- Power switch: The power is turned on/off.
- DIP switch: The functions of the DM-D110 are changed.  
(See “DIP switch” for details.)



**Note:**

*When turning on the DM-D110 again after turning it off, wait for at least 3 seconds.*

## DIP Switch

### *DIP Switch Functions*

The DM-D110 has one DIP switch. The functions of the DIP switch are as follows:

#### *DIP switch 1*

DSW1 No.	Function	ON	OFF	Default setting
1-1	Data receive error	Ignored	Displays “?”	OFF
1-2	Data length	7 bits	8 bits	OFF
1-3	Parity on or off	Parity	No parity	OFF
1-4	Parity type	Even	Odd	OFF
1-5	Change transmission speed	See “Transmission speed.”		ON
1-6				OFF
1-7				ON
1-8	Self test selection (*)	Perform self test	Do not perform	OFF

(\*)This function can select whether or not you perform self test when turning on the power. See “Self Test” for details.

#### *Transmission speed*

SW1-5	SW1-6	SW1-7	Transmission speed (bps)
ON	ON	ON	2400
OFF	ON	ON	4800
ON	OFF	ON	9600
OFF	OFF	ON	19200
ON	ON	OFF	38400
OFF	ON	OFF	57600
ON	OFF	OFF	115200
OFF	OFF	OFF	reserve

### Setting the DIP switches

#### **CAUTION:**

Turn off the DM-D110 while removing the DIP switch cover to prevent electrical damage to the DM-D110.

1. Turn off the power for the DM-D110.
2. Remove the DIP switch cover.

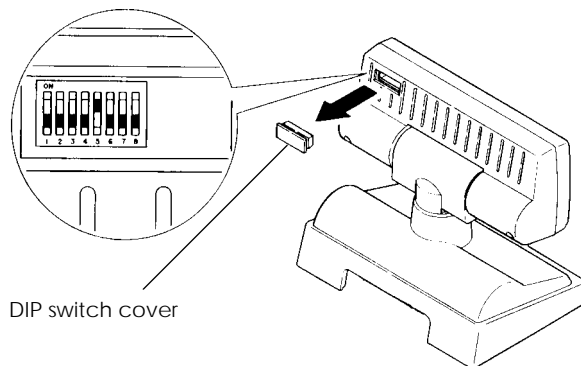

3. Change each setting of the switches with a pointed object, such as a pen tip or small screwdriver.
4. Close the cover, and turn the power on.

---

## *Turning and Tilting the DM-D110*

You can turn or tilt the display while holding the support. The display can be moved easily, so do not move any further if it stops. If you move it by force, you may damage it.

With the “DM-D pole unit for IR” (DP-504) and the “DM-D pole unit for TM printers (Type B)” (DP-503), the display area may not face the direction you desire. In this case, remove the base, change the position of the tab of the base so that the display faces to the direction you desire, and reattach it to the base.

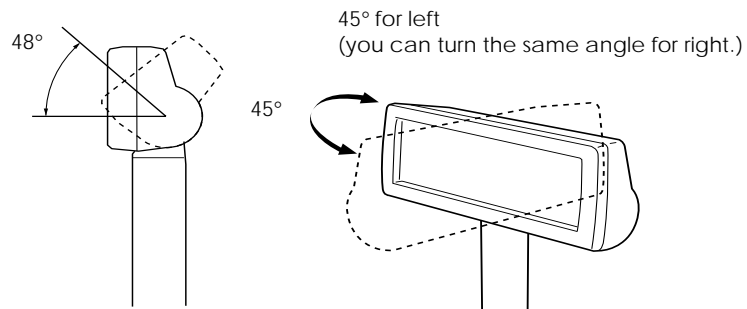

The display area has the following range of movement:

- Tilt: 48° max. (4 steps, 5 positions)
- Horizontal rotation: 90° max. (45° for each left and right)

## Self Test

The DM-D110 has a self test function. If you want to perform a self test, you must change the setting of the DIP switch.

### *Check Items of Self test*

The following items are checked during the self test:

- Control ROM version
- DIP switch settings
- Memory switch settings
- Example of display characters
- Example of each function, such as brightness, flashing, and scroll

### *Performing Self test*

To perform the self test, follow the steps below.

1. Turn off the power for the DM-D110.
2. Set the SW 1-8 of the DIP switch to ON, and turn on the power.



**Note:**

*If the contents of the self test are not displayed, the DM-D110 may be malfunctioning. Please contact your DM-D110 dealer for assistance.*

When the self test is finished and no error occurs, the DM-D110 is ready to receive data.

## Diagnostics

The DM-D110 has the diagnostics function. When the DM-D110 is turned on, diagnostics, such as internal memory test, is carried out regardless of the DIP switch settings. When an error is detected, the error message is displayed and no operation is carried out until power is turned off.

## Specification

### General Specifications

- Height, Width, Depth and Weight

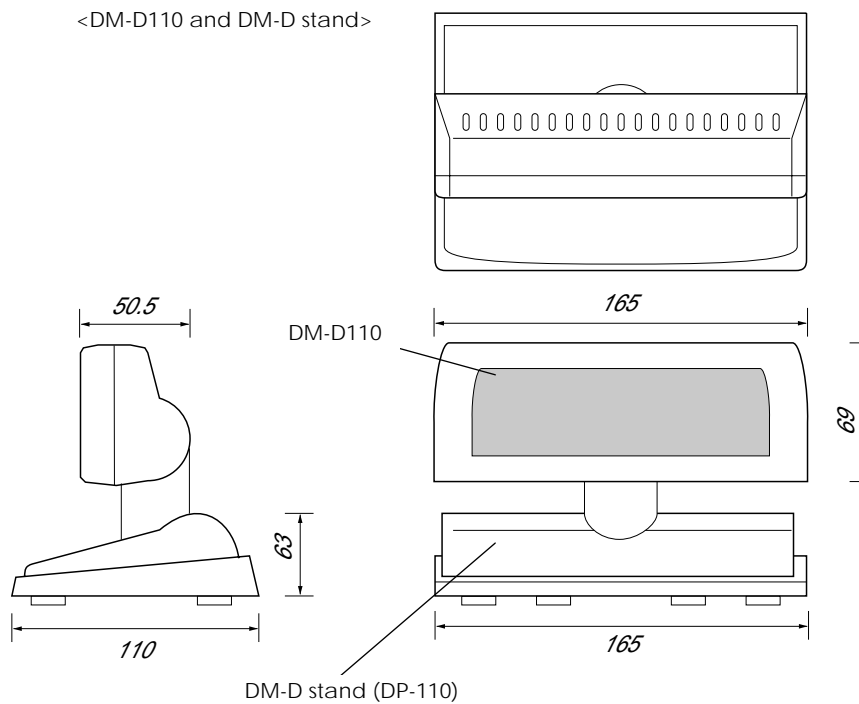

- DM-D110:
  - Height: 69 mm
  - Width: 165 mm
  - Depth: 50.5 mm
  - Weight: 285 g
- DM-D stand (DP-501):
  - Height: 63 mm
  - Width: 165 mm
  - Depth: 110 mm
  - Weight: 385 g

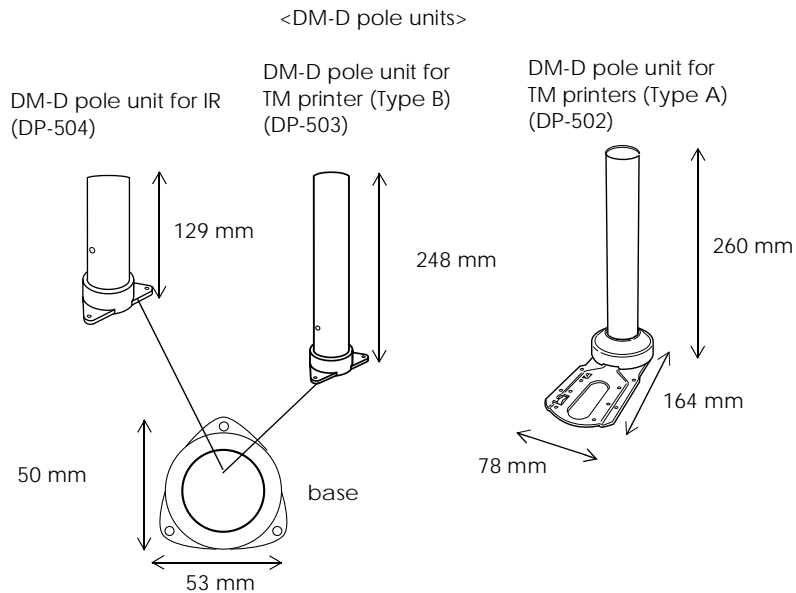

- Base and support A of the “DM-D pole unit for IR” (DP-504):
 

Height:	129 mm
Width:	50 mm
Depth:	53 mm
Weight:	60 g
- Base and support C of the “DM-D pole unit for TM printers (Type B)” (DP-503):
 

Height:	248 mm
Width:	50 mm
Depth:	53 mm
Weight:	116 g
- Fixing plate A and support C of the “DM-D pole unit for TM printers (Type A)” (DP-502):
 

Height:	260 mm
Width:	78 mm
Depth:	164 mm
Weight:	264 g

- ❑ Tilt angle      Max 48° (4 steps, 5 positions)
- ❑ Horizontal rotation  
                    Max 90° (for each left and right at 45°)
- ❑ Vacuum fluorescent display
  - Number of characters:    20 column × 2 lines max.
  - Display color:            Green (505 nm)
  - Brightness:                690 (cd/m<sup>2</sup>)

### *Electrical Specifications*

- ❑ Type            PS-170, PA-6508, PB-6509, PB-6510,  
                    PA-6511, PA-6513 (when using the DM-D stand)
- ❑ Rated voltage DC 11.4 to 48 V
- ❑ Rated current 0.2 A (max.)

### *Environmental Specifications*

- ❑ Operation environment
  - Temperature: 5°C to 40°C
  - Humidity:    30% to 85% (No condensation)
- ❑ Storage environment
  - Temperature: -10°C to 50°C
  - Humidity:    30% to 90% (No condensation)



### ***Character Specifications***

- ❑ Type of character
  - Alphanumeric characters: 95
  - International characters: 37
  - Extended graphics: 128 characters × 12 pages
- ❑ Character grid
  - Font : 5 × 7 dot, cursor
  - Character size 3.5 mm x 5.0 mm
  - Character pitch 5.2 mm

### ***Reliability Specification***

- ❑ MTBF (vacuum fluorescent display only)  
20,000 hours  
(a half-value period of the brightness)

