



MS9500 Voyager™ Series
Single-Line Hand-Held Laser Scanner
Installation and User's Guide



Locations

USA Corporate Headquarters

Metrologic Instruments, Inc.
90 Coles Road
Blackwood, NJ 08012-4683
Customer Service: 1-800-ID-METRO
Tel: 856-228-8100
Fax: 856-228-6673
Email: info@metrologic.com
www.metrologic.com

Europe

Metrologic Instruments GmbH
Dornierstrasse 2
82178 Puchheim b.
Munich, Germany
Tel: 49-89-89019-0
Fax: 49-89-89019-200
Email: info@europe.metrologic.com

South America

Metrologic South America
Rua Flórida, 1821 - 5° Andar
São Paulo, SP
CEP: 04571-090
Tel: 5511-5505-6568
Fax: 5511-5505-1681
Email: info@sa.metrologic.com

Asia

Metrologic Asia (Pte) Ltd.
31 Kaki Bukit Road 3
#05-08 Techlink
Singapore 417818
Tel: 65-842-7155
Fax: 65-842-7166
Email: info@sg.metrologic.com

Brazil

Metrologic do Brasil Ltda.
Rua Flórida, 1821 - 5° Andar
São Paulo, SP
CEP: 04571-090
Tel: 5511-5505-2396
Fax: 5511-5505-2301
Email: info@br.metrologic.com

Copyright

© 2000 by Metrologic® Instruments, Inc. All rights reserved. No part of this work may be reproduced, transmitted, or stored in any form or by any means without prior written consent, except by reviewer, who may quote brief passages in a review, or provided for in the Copyright Act of 1976.

Products and brand names mentioned in this document are trademarks of their respective companies.

MLPN 2410
Printed in USA

January 2000

Table of Contents

Introduction	1
Scanner and Accessories	2
Quick Start.....	3
Installing the Scanner to the Host System	4
Disconnecting PowerLink Cables from the Scanner.....	5
How to Use CodeGate – MS9540 Only.....	6
Assembling the Stand	7
Scanner Parts	9
Audible Indicators.....	10
Visual Indicators.....	11
Failure Modes	13
Programming Modes.....	14
Upgrading the Flash ROM Firmware	17
Labels	18
Depth of Field	19
IR Activation	20
Maintenance	21
Applications and Protocols	22
Trouble Shooting Guide	23
R232 Demonstration Program.....	28

Table of Contents (continued)

Appendix A

Design Specifications	29
-----------------------------	----

Appendix B

Default Settings.....	30
-----------------------	----

Appendix C

Pin Assignments	35
-----------------------	----

Appendix D

Warranty and Disclaimer.....	38
------------------------------	----

Appendix E

Notices.....	39
--------------	----

Appendix F

Patents.....	41
--------------	----

Addendum	42
----------------	----

Index.....	43
------------	----

Introduction

The Voyager™ MS9500 Series single-line hand-held scanners include both the MS9520 and MS9540.

The Voyager MS9540 features Metrologic's patented CodeGate™ technology. CodeGate is an intuitive scanning system that is ideal for all scanning applications, including menu-scanning, point-of-sale, document processing, and inventory control.

CodeGate works hand-in-hand with Metrologic's patented automatic-triggering scheme. Simply present a bar code to the scanner; the high-visibility 650-nanometer laser is automatically activated allowing the user to easily select the bar code to be scanned. Press the CodeGate button and the data is transmitted to the host system.

Equipped with both 'in-stand' and 'out-of-stand' operation, Voyager can be used as both a hand-held and fixed projection scanner. Voyager automatically senses when it is placed in the stand and de-activates the CodeGate button.

If the advantage of CodeGate technology is unnecessary in your application, then the MS9520 is the Voyager of choice. The MS9520 is packed with all of the same features as the MS9540, with the exception of CodeGate.

Metrologic has included many standard features such as: user upgradeable Flash ROM, PowerLink user-replaceable cables, MetroSet™ and METROSELECT® configuration, EMI rating of Class B, data editing (parsing) capability using Bits 'n' Pieces™, and a 2-year warranty.

Voyager	Voyager - CodeGate	Interface
MS9520 – 9	MS9540 – 9	OCIA
MS9520 – 11	MS9540 – 11	IBM 468X/469X
MS9520 – 41	MS9540 – 41	Full RS-232C and Light Pen Emulation
MS9520 – 47	MS9540 – 47	Keyboard Wedge and Stand-Alone Keyboard

Scanner and Accessories

The following list of parts may or may not be included in the MS9500 kit.

- **Voyager MS9520** Single-Line Laser Scanner, or
Voyager MS9540 – CodeGate™ Single-Line Laser Scanner
- **AC to DC Power Transformer** – Regulated 5.2VDC @ 650 mA output . One of the following may be included:
 - 120 V United States: MLPN 45-45593
 - 220 V – 240 V Continental European: MLPN 45-45591
 - 220 V – 240 V United Kingdom: MLPN 45-45592
- **PowerLink Cable** with built in power jack. One of the following may be included:
 - Standard: MLPN 53xxx* - 2.7 m (9') coiled cord, long strain relief
 - or
 - Optional: MLPN 54xxx* - 2.1 m (7") straight cord, short strain relief
 - *xxx specifies connection to host
- **Stand** with mounting accessories
 - Clip-in Stand: MLPN 46-46055, or
 - Mask Stand: MLPN 46-46128
- **Installation and User's Guide** – MLPN 2410
 - Available on Metrologic website – www.metrologic.com
- **MetroSelect Scanner Configuration Guide** – MLPN 2407
 - Available on Metrologic website – www.metrologic.com

Other items may be ordered for the specific protocol being used. To order additional items, contact the dealer, distributor or call Metrologic's Customer Service Department at 1-800-ID-METRO or 1-800-436-3876.

Caution:

To maintain compliance with applicable standards, all circuits connected to the scanner must meet the requirements for SELV (Safety Extra Low Voltage) according to EN 60950.

To maintain compliance with standard CSA C22.2 No. 950/UL 1950 and norm EN 60950, the power source should meet applicable performance requirements for a limited power source.

Quick Start

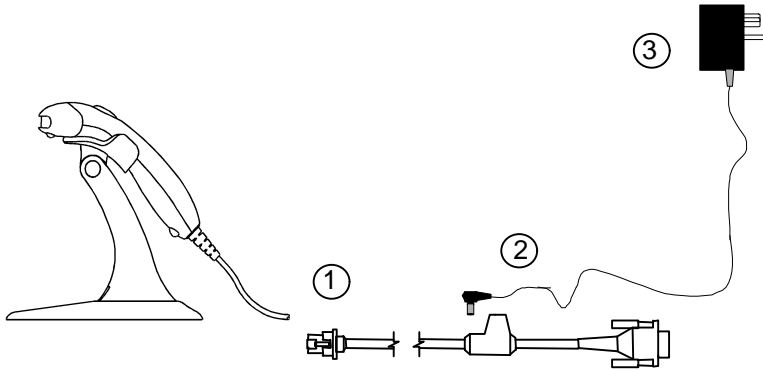

1. Connect the 10-pin RJ45 male connector into the jack on the Voyager. You will hear a 'click' when the connection is made.
2. Connect the L-shaped plug of the power supply into the power jack on the PowerLink cable.
3. Connect the power supply into an AC outlet. Make sure the AC input requirements of the power supply match the AC outlet.



4. When the Voyager is ready to scan, the green LED will turn on, the red LED will flash and the scanner will beep once.



5. Place a bar code in front of the scanning window. The scanner will beep once and flash the red LED if the bar code was successfully decoded. For the MS9540, press the CodeGate button to transmit the data.

NOTE: Voyager is shipped from the factory programmed with default settings. Refer to the METROSELECT® Programming Guide for instructions on how to configure the scanner.

Installing the Scanner to the Host System

1. Turn off the host system.
2. Make the proper PowerLink cable connections to the scanner. Please refer to the Quick Start section of this manual for proper installation of the cable and power supply. **NOTE:** If the Voyager is receiving power from the host system, please skip step #2 and step #3 in the Quick Start section of this manual.
3. Connect the PowerLink cable to the proper port on the host system.
4. Turn on the host system.

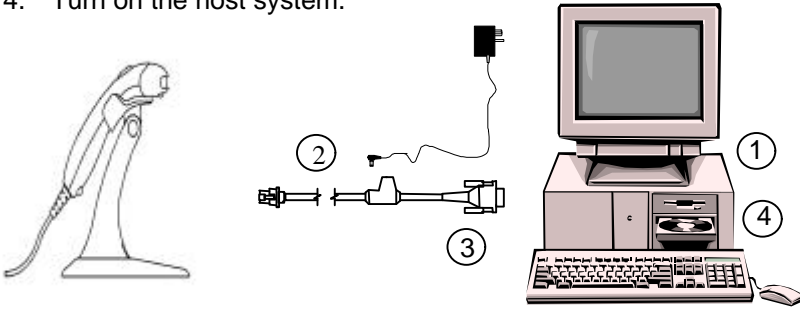

Note: Plugging the scanner into a port on the host system does not guarantee that scanned information will be communicated properly to the host system. The scanner is shipped from the factory programmed with default settings. Please refer to the MetroSelect Configuration Guide (MLPN 2407) for instructions on changing the scanner's configuration. In addition, please check that the scanner and host system are using the same communication protocol.

Disconnecting PowerLink Cables from the Scanner

Before removing the cable from the scanner, Metrologic recommends that the power on the host system is off and the power supply has been disconnected from the PowerLink cable.

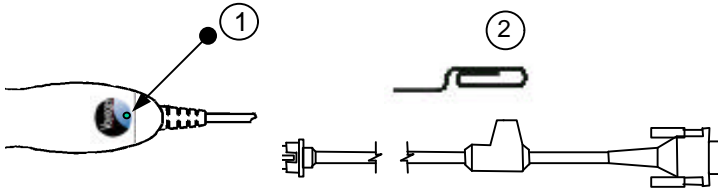

1. Locate the small 'pin-hole' on the top of the unit near the bottom of the Voyager logo.
2. Bend an ordinary paperclip into the shape shown above.
3. Insert the paperclip (or other small metallic pin) into the small 'pin-hole'.
4. You will here a faint 'click'. Pull gently on the strain-relief of the PowerLink cable and it will slide out of the scanner.

How to Use CodeGate – MS9540 Only

1 _____

2 

3 

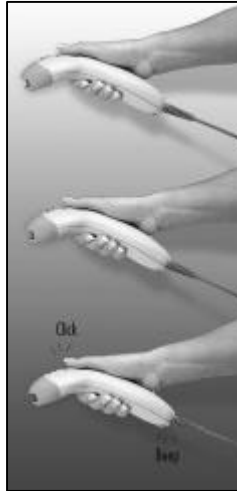

- Auto trigger activates the laser
- Place the laser line on the bar code
- Press the CodeGate button to transmit the data

Two Modes of Operation



- Auto-trigger while in the stand
- Bar code is automatically decoded and transmitted



- CodeGate activates when removed from the stand
- Bar code data is transmitted when the CodeGate button is pressed

Assembling the Stand

Kit #46-46055 Contains:

- | | | | |
|----|---------------------------|-----------------|-------|
| a. | Stand | (mlpn 36-00343) | Qty 1 |
| b. | Apron | (mlpn 50-50440) | Qty 1 |
| c. | Screw, M3 x 6 mm long | (mlpn 18-18670) | Qty 2 |
| d. | Washer, #5 x .5 OD | (mlpn 18-18671) | Qty 2 |
| e. | Stand Anchor | (mlpn 50-50449) | Qty 1 |
| f. | Wood Screw, #8 Round Head | (mlpn 18-18057) | Qty 4 |
| g. | Base | (mlpn 36-36080) | Qty 1 |

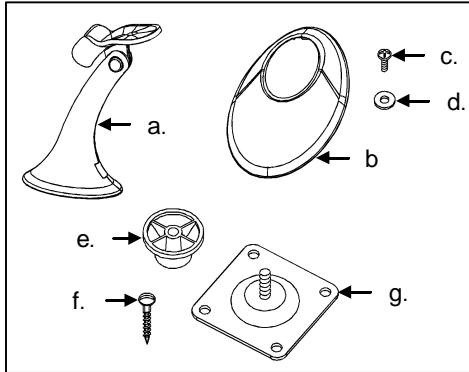

There are 2 options for assembling the stand. The first option allows the stand to be self-supporting and moved freely or placed anywhere on the countertop. The second option is used if the stand will be bolted/hard-mounted to the countertop.

Stand Option 1: Self-supported

Step 1

Slide the apron (mlpn 50-50440) over the stand (mlpn 36-00343).

Step 2

Position the stand so it sits under the tab on the apron. Then secure the apron to the stand using the M3 x 6 mm screws (mlpn18-18670) and the #5 washers (mlpn 18-18671) provided.

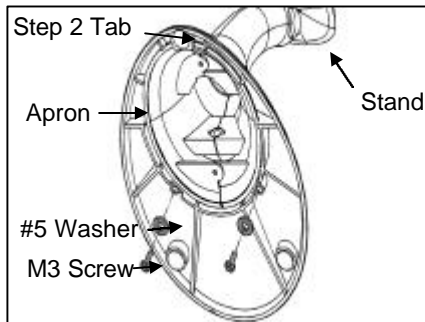
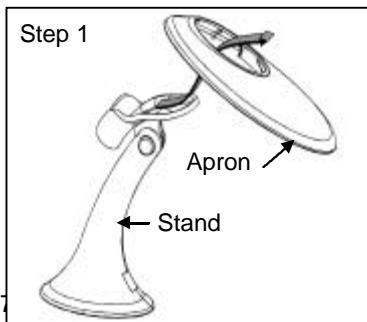

Assembling the Stand (continued)

Stand Option 2: Hard-mounted to countertop

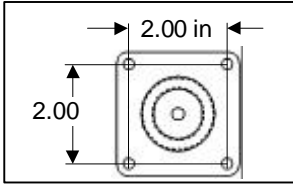

Step 1

Drill four #39 holes in the countertop.

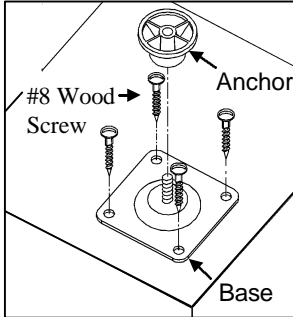

Step 2

Secure the base (mlpn 36-36080) to the countertop with the four #8 wood screws (mlpn 18-18057) provided.

Step 3

Screw the anchor (mlpn 50-50449) onto the base until it sits flush.

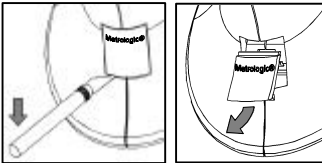

Step 4

Remove the logo plate on the stand by gently using an exacto knife to release the plate hook.

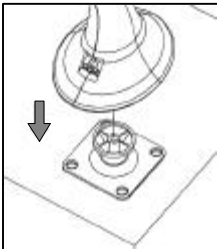

Step 5

Position the stand over the base assembly.

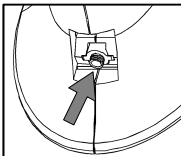

Step 6

Secure the stand to the base assembly by tightening the set screw located under the logo plate.

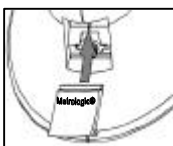

Step 7

Snap the logo plate back into place.

Scanner Parts

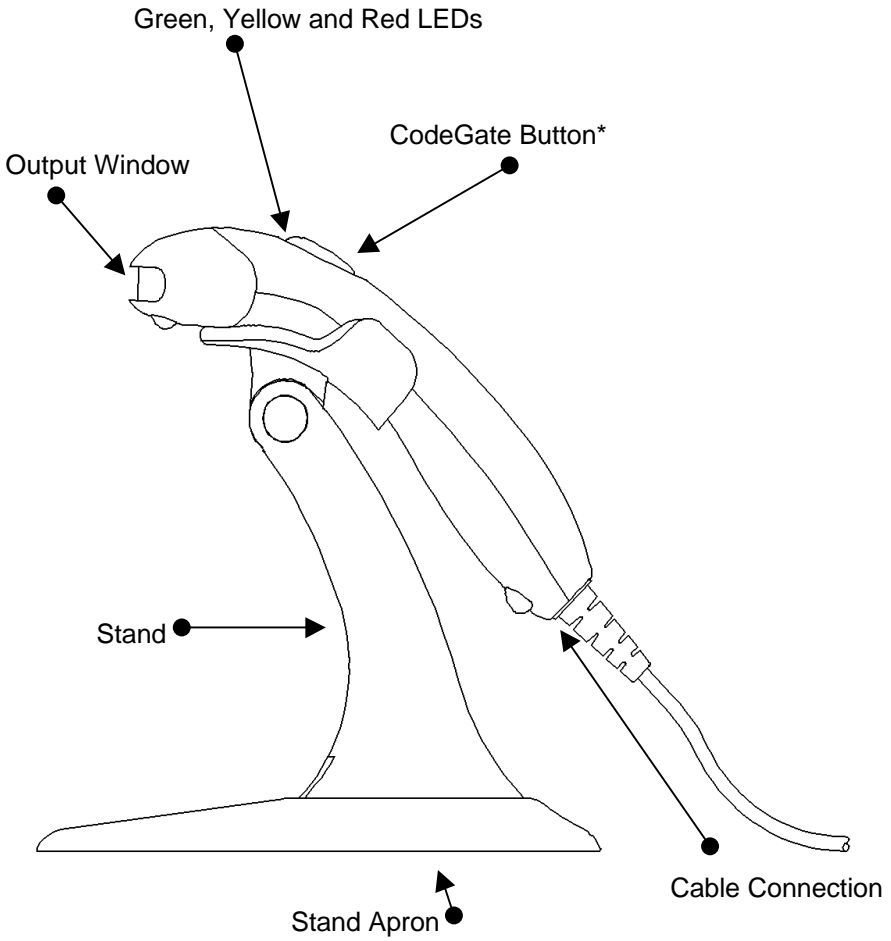

*This feature is not available on the MS9520

Audible Indicators

When the Voyager is in operation, it provides audible feedback. These sounds indicate the status of the scanner. Eight settings are available for the tone of the beep (normal, 6 alternate tones and no tone). To change the tone, refer to the MetroSelect Programming Guide MLPN 2407.



One Beep

When the scanner *first* receives power, the green LED will turn on, then the red LED will flash and the scanner will beep once. (The red LED will remain on for the duration of the beep.) The scanner is ready to scan.

When the scanner *successfully* reads a bar code, the red LED will flash and the scanner beeps once (if programmed to do so). If the scanner does not beep once and the green light does not flash, then the bar code has *not* been successfully read.



Razzberry Tone

This tone is a failure indicator. Refer to "Failure Modes" page 13.



Three Beeps - During Operation

When entering configuration mode, the red LED will flash while the scanner simultaneously beeps three times. The red and green LEDs will continue to flash while in this mode. Upon exiting configuration mode, the scanner will beep three times, and the LEDs will stop flashing.

When configured, 3 beeps can also indicate a communications timeout during normal scanning mode.

When using one-code-programming, the scanner will beep three times (the current selected tone), followed by a short pause then by a high tone and a low tone. This tells the user that the single configuration bar code has successfully configured the scanner.



Three Beeps - On Power Up

This is a failure indicator. Refer to "Failure Modes" on page 13.

Visual Indicators

There are three LED indicators (green, red and yellow) located on the head of the MS9500. When the scanner is on, the flashing or stationary activity of the LEDs indicates the status of the current scan and the scanner.

Green, Red & Yellow LEDs are off



The LEDs will not be illuminated if the scanner is not receiving power from the host or transformer.

The scanner is stand-by mode, and CodeGate is enabled. Present a bar code to the scanner and the green LED will turn on when the laser turns on.



Steady Yellow

The CodeGate button is not active. If a bar code is in the scan field, the laser will turn on. The bar code will be decoded and transmitted to the host automatically.



Steady Green

When the laser is active, the green LED is illuminated. The green LED will remain illuminated until the laser is deactivated.



Steady Green and Single Red Flash

When the scanner successfully reads a bar code, the red LED will flash and the scanner will beep once. If the red LED does not flash or the scanner does not beep once, then the bar code has not been successfully read.



Steady Green and Steady Red

After a successful scan, the scanner transmits the data to the host device. Some communication modes require that the host inform the scanner when data is ready to be received. If the host is not ready to accept the information, the scanner's red LED will remain on until the data can be transmitted.

Visual Indicators (continued)



Alternating Flashing of Green and Red

This indicates the scanner is program mode. A razzberry tone indicates that an invalid bar code has been scanned while in this mode.



Steady Red, Green off

This indicates the scanner may be waiting for communication from the host.

Failure Modes



Flashing Green and one Razzberry Tone

This indicates the scanner has experienced a laser sub-system failure. Return the unit for repair to an authorized service center.



Flashing Red and Green with Two Razzberry Tones

This indicates the scanner has experienced a scanning mechanism failure. Return the unit for repair to an authorized service center.



Continuous Razzberry Tone with all LEDs off

If, upon power, the scanner emits a continuous razzberry tone, then the scanner has experienced an electronic failure. Return the unit for repair to an authorized service center.



Three Beeps – on power up

If the scanner beeps 3 times on power up then, the non-volatile memory (NovRAM) that holds the scanner configuration has failed. Return the unit for repair to an authorized service center.

Programming Modes

The MS9500 Voyager has 3 modes of programming.

Bar Codes: Voyager can be configured by scanning the bar codes located in the METROSELECT® Configuration Guide (MLPN 2407). Please refer to this guide for instructions. This manual can be downloaded for FREE from Metrologic's website (www.metrologic.com).

MetroSet™: This user-friendly Windows-based configuration program allows you to simply 'point-and-click' at the desired scanner options. This program can be downloaded for FREE from Metrologic' website (www.metrologic.com), or set-up disks can be ordered by calling 1-800-ID-METRO.

Serial Programming: This mode of programming is ideal for OEM applications. This mode gives the end-user the ability to send a series of commands using the serial port of the host system. The commands are equivalent to the numerical values of the bar codes located in the MetroSelect Configuration Guide (MLPN 2407).

How does Serial Programming work?

1. Each command sent to the scanner is the ASCII representation of each numeral in the configuration bar code. The entire numeric string is framed with an ASCII [stx] and an ASCII [etx].

EXAMPLE #1: Command for Disabling Codabar

Command = [stx]100104[etx]

String Sent to Scanner = 02h 31h 30h 30h 31h 30h 34h 03h

(All values are hexadecimal).

2. If the command sent to the scanner is valid, the scanner will respond with an [ack].
3. If the command sent to the scanner is invalid, the scanner will respond with a [nak].

NOTE: If this occurs, the end-user must start over at the very beginning of the configuration sequence. Simply re-transmitting the invalid command will not work, you must start over.

Programming Modes (continued)

4. During programming, the motor and laser remain active. YOU CANNOT SCAN ANY BAR CODES WHILE IN PROGRAM MODE.
5. There is a 20 second window between commands. If a 20 second timeout occurs, the scanner will send a [nak] and you must start over.
6. To enter serial program mode, send the following command [stx]999999[etx].
7. To exit serial program mode, send the following command [stx]999999[etx], the scanner will respond with an [ack] and a long beep.
8. This mode uses the current Baud Rate, Parity, Stop Bits and Data Bits settings that are configured in the scanner. The default settings of the scanner are 9600, Space, 2, 7 respectively. If a command is sent to the scanner to change any of these settings, the change will NOT take effect until after serial program mode is exited.

EXAMPLE #2: The following example will set the scanner to the factory default settings, Disable Scanning of Code 128 bar codes, change the beeper tone, and add a “G” as a programmable prefix.

FEATURE	HOST COMMAND	ASCII REPRESENTATION	SCANNER RESPONSE
Enter Program Mode	[stx]999999[etx]	02h 39h 39h 39h 39h 39h 39h 03h	[ack] or 06h
Load Defaults	[stx]999998[etx]	02h 39h 39h 39h 39h 39h 38h 03h	[ack] or 06h
Disable Code 128	[stx]100113[etx]	02h 31h 30h 30h 31h 31h 33h 03h	[ack] or 06h
Alternate Tone 1	[stx]318565[etx]	02h 33h 31h 38h 35h 36h 35h 03h	[ack] or 06h
Prog. Prefix #1	[stx]903500[etx]	02h 39h 30h 33h 35h 30h 30h 03h	[ack] or 06h
Code Byte 0	[stx]0[etx]	02h 30h 03h	[ack] or 06h
Code Byte 7	[stx]7[etx]	02h 37h 03h	[ack] or 06h
Code Byte 1	[stx]1[etx]	02h 31h 03h	[ack] or 06h
Exit Program Mode	[stx]999999[etx]	02h 39h 39h 39h 39h 39h 39h 03h	[ack] or 06h

The scanner will emit a long beep!

The commands sent to the scanner do not include the small superscripted ‘3’ that you see in front of each bar code string in the MetroSelect manual. THE ‘3’ SHOULD NOT BE SENT, IT IS A CODE TYPE DESIGNATION ONLY!

As you will note for commands requiring additional bar codes to be scanned (such as prefixes, suffixes, timeouts, etc.), simply send the code bytes in the same order that you would normally scan the bar codes.

Programming Modes (continued)

EXAMPLE #3: The following example shows the events that occur when an invalid bar code is sent. This sample will load the factory default settings and then set the baud rate to 19200.

<u>FEATURE</u>	<u>HOST COMMAND</u>	<u>ASCII REPRESENTATION</u>	<u>SCANNER RESPONSE</u>
Enter Program Mode	[stx]999999[etx]	02h 39h 39h 39h 39h 39h 39h 03h	[ack] or 06h
Load Defaults	[stx]999999:[etx]	02h 39h 39h 39h 39h 39h 3Ah 03h	[nak] or 15h
Invalid command was sent, you must start over!			
Enter Program Mode	[stx]999999[etx]	02h 39h 39h 39h 39h 39h 39h 03h	[ack] or 06h
Load Defaults	[stx]999998[etx]	02h 39h 39h 39h 39h 39h 39h 03h	[ack] or 06h
19200 Baud Rate	[stx]415870[etx]	02h 34h 31h 35h 38h 37h 30h 03h	[ack] or 06h
Exit Program Mode	[stx]999999[etx]	02h 39h 39h 39h 39h 39h 39h 03h	[ack] or 06h
The scanner will emit a long beep!			

This example illustrates two important points.

First, if an invalid command is sent from the host, the scanner responds with a [nak] and the end-user must start over from the beginning.

Second, if a command is sent to change the Baud Rate, the new baud rate does not take effect until after the end-user exits program mode.

ABBREVIATED ASCII TABLE

Character	Hex Value	Decimal Value
[STX]	02h	2
[ETX]	03h	3
[ACK]	06h	6
[NAK]	15h	21
0	30h	48
1	31h	49
2	32h	50
3	33h	51
4	34h	52
5	35h	53
6	36h	54
7	37h	55
8	38h	56
9	39h	57

Upgrading the Flash Rom Firmware

The **Meteor** program is a functional component of Metrologic's new line of flash-based scanners. This program allows the user of a Metrologic scanner to quickly upgrade to a new or custom version of software. It requires the use of a personal computer running under Windows 95 or greater and the use of a communication port. The user merely connects the scanner to a communications port of the PC, launches the **Meteor** program, and blasts off to new software upgrades.

Each MS9500, regardless of the version number or communication protocol, can be upgraded. In other words, all RS232 (-41), keyboard wedge (-47), light pen (-41), OCIA (-9) and IBM 468X/469X (-11) units can be upgraded. To upgrade all units, a power supply and PowerLink cable (MLPN 54012) are required.

The upgrades and custom software versions will be supplied by Metrologic in files called Motorola S-record files. These files contain all the information needed to upgrade the scanner. Simply add this file to the working directory or retrieve from its current location.

The program guides the user with its simplistic one click approach. The user must first select the file; once selected and verified, the file is ready to be used in the upgrade. Press the button to upgrade the scanner, the unit will go into a "flash mode" – both the green and red LEDs will be on. The user can follow the progress of the upgrade by watching the screen for details. When the upgrade is complete, the scanner will respond with its normal one beep on power up. If two beeps occur, the scanner did not upgrade properly. (Contact Metrologic for additional details).

Labels

Each scanner has a label on the back of the unit. This label has the model number, date of manufacture, serial number, CE and caution information. The following is an example of this label:

AVOID EXPOSURE laser light emitted from this aperture

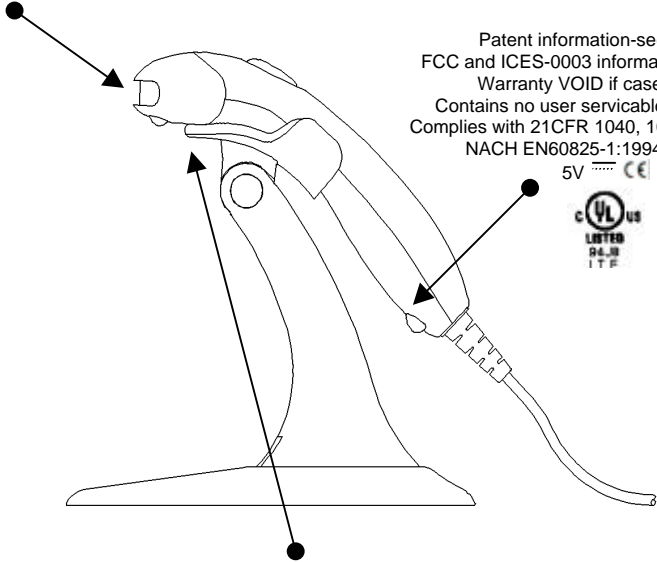

Patent information-see manual
 FCC and ICES-0003 information-see manual
 Warranty VOID if case opened.
 Contains no user servicable components.
 Complies with 21CFR 1040, 1040.01 & 1040.11
 NACH EN60825-1:1994/A11:1996



Metrologic Instruments Inc.
 Manufactured in Blackwood New Jersey, USA

Model: MS9540
 RS232
 3500020166

January 2000
 5V Prototype
AVOID EXPOSURE
 Laser Light is emitted
 from the aperture

OO



Depth of Field

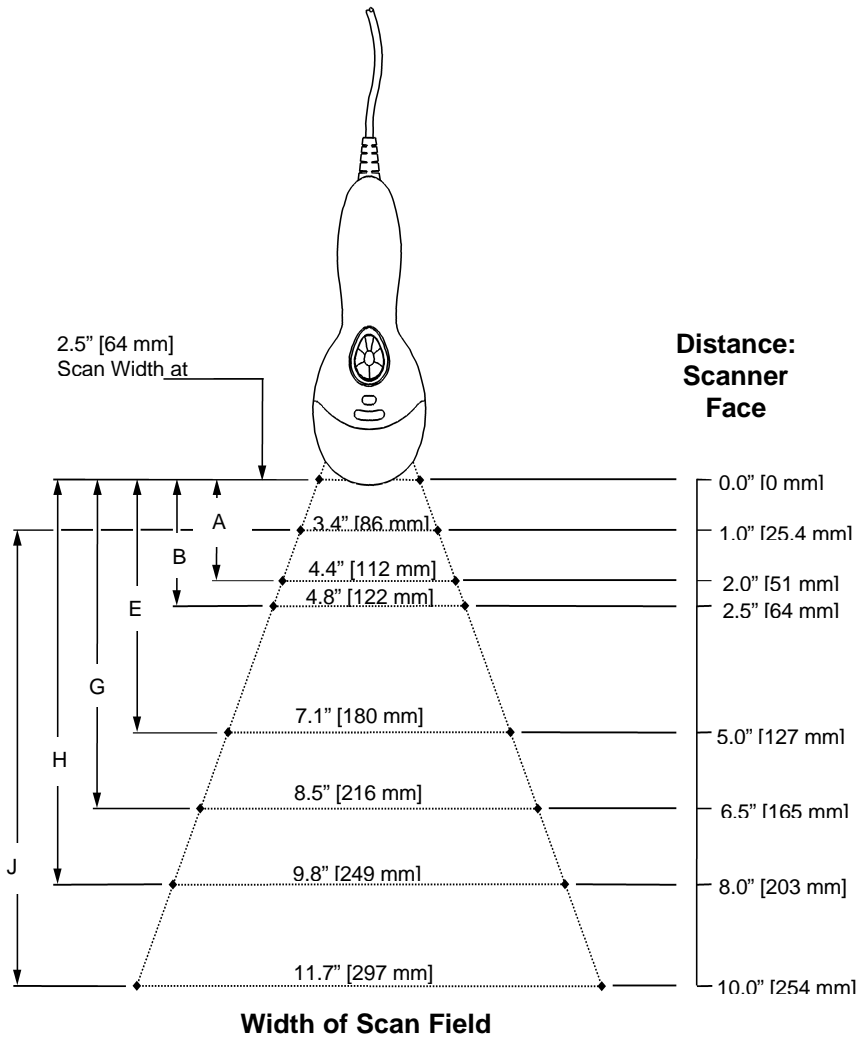

Minimum Bar Code Element Width										
	A	B	C	D	E	F	G	H	J	K
mm	.13	.15	-	-	.19	-	.25	.33	.53	-
mils	5.2	5.7	-	-	7.5	-	10	13	21	-

IR Activation

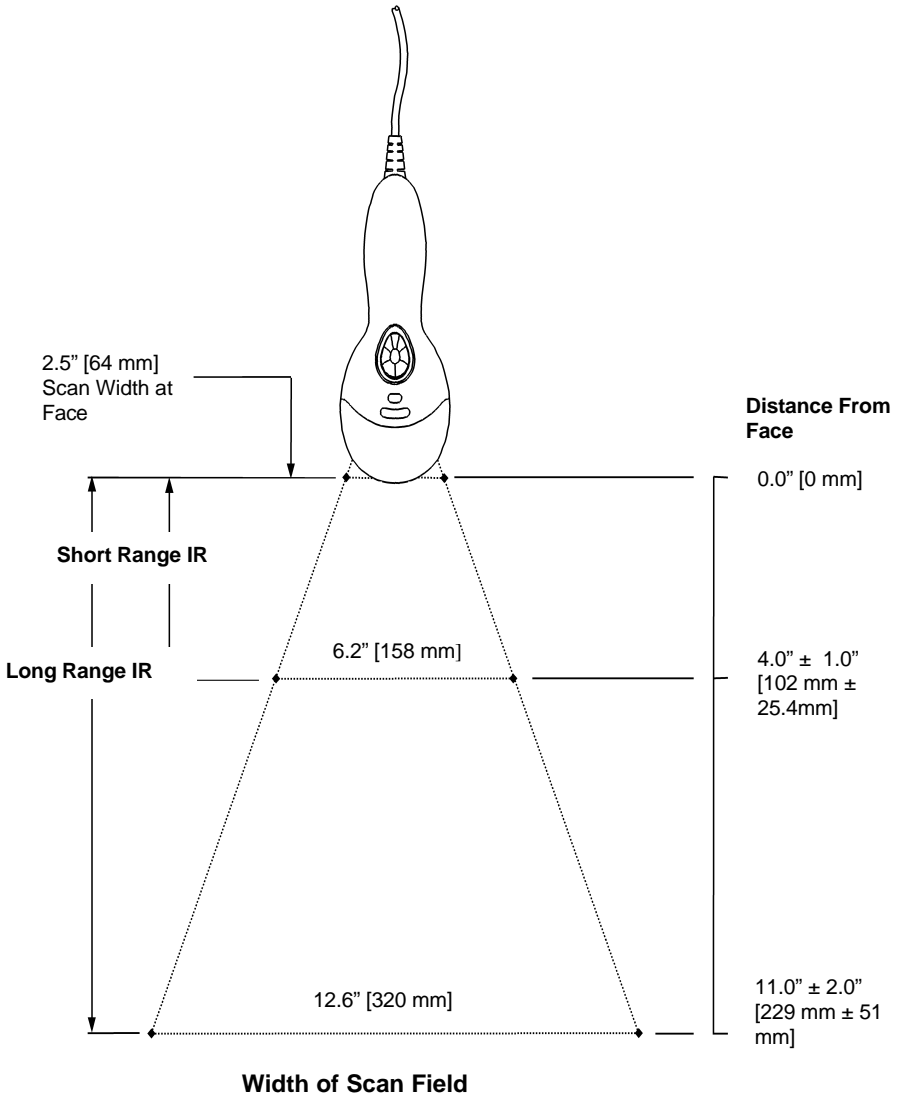

Maintenance

Smudges and dirt can interfere with the proper scanning of a bar code. Therefore, the output window will need occasional cleaning.

1. Spray glass cleaner onto lint free, non-abrasive cleaning cloth.
2. Gently wipe the scanner window.

Applications and Protocols

The model number on each scanner includes the scanner number and factory default communications protocol.

Scanner	Version Identifier	Communication Protocol(s)
MS9520 MS9540	41	Full RS-232C/Light Pen Emulation
MS9520 MS9540	47	Keyboard Wedge, Stand-Alone Keyboard and RS-232 Transmit/Receive
MS9520 MS9540	9	OCIA and RS-232 Transmit/Receive
MS9520 MS9540	11	IBM 46XX and Full RS-232C

The MS9500 Series Hand-Held Laser Scanner with built-in PC Keyboard Wedge Interface is designed to be used for Keyboard emulation only. Many RS-232 programmable functions available in other Metrologic scanners are also available as keyboard wedge functions.

The following are the most important selectable options specific to the keyboard wedge.

Keyboard Type

- **AT (includes IBM® PS2 models 50, 55, 60, 80)
- XT
- IBM PS2 (includes models 30, 70, 8556)

Keyboard Country Type

- **USA
- French
- Italian
- Belgium
- Japanese
- United Kingdom
- German
- Spanish
- Swiss

**Default setting. Refer to Appendix B pages 30-34 for default settings. Refer to the METROSELECT® Programming Guide (MLPN 2407) for information on how to change the default settings.

Trouble Shooting Guide

The following guide is for reference purposes only. Contact a Metrologic representative at 1-800-ID-Metro or 1-800-436-3876 to preserve the limited warranty terms.

All Interfaces

MS9500 Series Troubleshooting Guide		
Symptoms	Possible Causes	Solution
No LEDs, beep or laser	No power is being supplied to the scanner	Check transformer, outlet and power strip. Make sure the cable is plugged into the scanner
No LEDs, beep, or laser	No power is being supplied to the scanner from host	Some host systems cannot supply enough current to power Voyager. A power supply may be needed.
3 Beeps on power up	Non-volatile RAM failure	Contact a Metrologic Representative, if the unit will not hold the programmed configuration
Continuous razz tone on power up	RAM or ROM failure	Contact a Metrologic Representative, if the unit will not function
Razz tone and green LED flash at power up	VLD failure	Contact a Metrologic Representative
Razz tone, red and green LEDs flash at power up	Scanning mechanism failure	Contact a Metrologic Representative
Unit scans, Communicates and beeps twice	Same symbol timeout set too short	Adjust same symbol timeout for a longer time

Troubleshooting Guide (continued)

Symptoms	Possible Causes	Solution
The unit powers up, but does not scan/or beep	Beeper disabled. No tone selected	Enable beeper. Select tone
The unit powers up, but does not scan and/or beep	Scanning a particular symbology that is not enabled	UPC/EAN, Code 39, interleaved 2 of 5, Code 93, Code 128 and Codabar are enabled by default. Verify that the type of bar code being read has been selected
The unit powers up, but does not scan and/or beep	The scanner has been programmed for a character length lock, or a minimum length and bar code being scanned does not satisfy the programmed criteria	Verify that the bar code that is being scanned falls into the criteria (Typical of Non-UPC/EAN codes) <i>The scanner defaults to a minimum of 3 character bar code</i>
The unit scans a bar code, but locks up after the first scan red LED stays on	The scanner is configured to support some form of host handshaking but is not receiving the signal	If the scanner is setup to support ACK/NAK, RTS/CTS, XON/XOFF or D/E, verify that the host cable and host are supporting the handshaking properly
The unit scans, but the data transmitted to the host is incorrect	The scanner's data format does not match the host system requirements	Verify that the scanner's data format matches that required by the host. Most sure that the scanner is connected to the proper host port

Troubleshooting Guide (continued)

Symptoms	Possible Causes	Solution
Scanner beeps at some bar codes and NOT for others of the same bar code symbology	The print quality of the bar code is suspect	Check print mode. The type of printer could be the problem. Change print settings. i.e. change to econo mode or high speed
Scanner beeps at some bar codes and NOT for others of the same bar code symbology	The aspect ratio of the bar code is out of tolerance	Check print mode. The type of printer could be the problem. Change print settings. i.e. change to econo mode or high speed
Scanner beeps at some bar codes and NOT for others of the same bar code symbology	The bar code may have been printed incorrectly	Check if it is a check digit/character/or border problem
Scanner beeps at some bar codes and NOT for others of the same bar code symbology	The scanner is not configured correctly for this type of bar code	Check if check digits are set properly
Scanner beeps at some bar codes and NOT for others of the same bar code symbology	The minimum symbol length setting does not work with the bar code	Check if the correct minimum symbol length is set

Troubleshooting Guide (continued)

Symptoms	Possible Causes	Solution
The unit scans the bar code but there is no data	Configuration is not correct	Make sure the scanner is configured for the appropriate mode. Check internal jumper
The unit scans but the data is not correct	Configuration is correct	Make sure that the proper PC type AT, PS2 or XT is selected. Verify correct country code and data formatting are selected. Adjust inter-character delay symptom
The unit is transmitting each character twice	Configuration is not correct	Increase interscan code delay setting. Adjust whether the F0 break is transmitted. It may be necessary to try this in both settings
Alpha characters show as lower case	Computer is in Caps Lock mode	Enable Caps Lock detect setting of the scanner to detect whether the PC is operating in Caps Lock
Everything works except for a couple of characters	These characters may not be supported by that country's key look up table	Try operating the scanner in Alt mode

Troubleshooting Guide (continued)

Symptoms	Possible Causes	Solution
Power-up OK and scans OK ,but does not communicate properly to the host	Com port at the host is not working or configured properly	Check to make sure that the baud rate and parity of the scanner and the communication port match and the program is looking for "RS-232" data
Power-up OK and scans OK ,but does not communicate properly to the host	Cable not connected to the proper com port	Check to make sure that the baud rate and parity of the scanner and the communication port match and the program is looking for "RS-232" data
Power-up OK and scans OK ,but does not communicate properly to the host	Cable not connected to the proper com port	Check to make sure that the baud rate and parity of the scanner and the communication port match and the program is looking for "RS-232" data
The host is receiving data but the data does not look correct	The scanner and host may not be configured for the same interface parameters	Check that the scanner and the host are configured for the same interface parameters
Characters are being dropped	Inter-character delay needs to be added to the transmitted output	Add some inter-character delay to the transmitted output by using the MetroSelect Programming Guide MLPN 2407

RS-232 Demonstration Program

If an RS-232 scanner is not communicating with your IBM compatible PC, key in the following BASIC program to test that the communication port and scanner are working.

This program is for demonstration purposes only. It is only intended to prove that cabling is correct, the com port is working, and the scanner is working. If the bar code data displays on the screen while using this program, it only demonstrates that the hardware interface and scanner are working. At this point, investigate whether the application software and the scanner configuration match.

If the application does not support RS-232 scanners, a software wedge program that will take RS-232 data and place it into a keyboard buffer may be needed. This program tells the PC to ignore RTS-CTS, Data Set Ready (DSR) and Data Carrier Detect (DCD) signals. If the demonstration program works and yours still does not, jumper RTS to CTS and Data Terminal Reading (DTR) to DCD and DSR on the back of your PC.

```
10      CLS
20      ON ERROR GOTO 100
30      OPEN "COM1:9600,S,7,1,CSO,DSO,CD0,LF" AS#1
35      PRINT "SCAN A FEW BAR CODES"
40      LINE INPUT #1, BARCODE$
50      PRINT BARCODE$
60      K$ = INKEY$: IF K$ = CHR$(27) THEN GOTO 32766
70      GOTO 40
100     PRINT "ERROR NO. "; ERR ; "PRESS ANY KEY TO
        TERMINATE."
110     KK$ = INKEY$: IF K$ = "" THEN GOTO 110
32766   CLOSE: SYSTEM
32767   END
```

Appendix A – Design Specifications

Operational

Light Source	Visible Laser Diode 650 nm \pm 10 nm
Laser Power	0.96 mW (peak)
Depth of Scan Field	0 mm – 203 mm (0" – 8" for 0.330 mm (13 mil) bar code at default setting)
Scan Speed	72 scan lines per second
Scan Pattern	Single scan line
Minimum Bar Width	0.127 mm (5.0 mil)
InfraRed Activation	Long Range: 0 mm – 279 mm \pm 51 mm (0" – 11" \pm 2") Short Range: 0mm – 102 mm \pm 25 mm (0" – 4" \pm 1")
Decode Capability	Autodiscriminates all standard bar codes' for others call Metrologic
System Interfaces	RS232, PC Keyboard Wedge, Stand-Alone Keyboard, OCIA, IBM 468X/469X, Light Pen Emulation
Print Contrast	35% minimum reflectance difference
Number Characters Read	Up to 80 data characters (Maximum number will vary based on symbology and density)
Roll, Pitch, Yaw	42°, 68°, 52°
Beeper Operation	7 tones or no beep
Indicators (LED)	Green = laser on, ready to scan Red = good read Yellow (MS9540 Only) = CodeGate button is inactive (on). CodeGate button is active (off)

Mechanical

Length	198 mm (7.8")
Width-Handle	45 mm (1.8")
Width-Head	78 mm (3.1")
Depth	40 mm (1.6")
Weight	149 g (5.25 oz)
Cable	Standard 2.7 m (9') coiled; optional 2.1 m (7') straight

Electrical

Input Voltage	5 VDC \pm 0.25 V
Power – Operating	0.825 W
Power – Standby	0.600 W
Current – Operating	165 mA @ 5 VDC
Current – Standby	120 mA @ 5 VDC
DC Transformers	Class 2; 5.2V @ 650 mA
Laser Class	CDRH: Class II; EN60825-1:1994/A11:1996 Class 1
EMC	FCC Class B

Environmental

Operating Temperature	0°C to 40° (32° to 104°F)
Storage Temperature	-40°C to 60°C (-40°F to 140°F)
Humidity	5% to 95% relative humidity, non-condensing
Light Levels	Up to 4842 Lux (450 footcandles)
Shock	Designed to withstand 1.5 m (5') drops
Contaminants	Sealed to resist airborne particulate contaminants
Ventilation	None required

Appendix B – Default Settings

Many functions of the scanner can be “programmed” – that is, enabled or disabled. The scanner is shipped from the factory programmed to a set of default conditions. The default parameter of the scanner has an asterisk (*) in the charts on the following pages. If an asterisk is not in the default column then the default setting is OFF or DISABLED. Every communication does not support every parameter. If the communication supports a parameter listed in the charts on the following pages, a check mark will appear.

PARAMETER	DEFAULT	OCIA	RS-232	LIGHT PEN	IBM 46XX	KBW
Normal Scan Mode	*					
Continuous Scan Mode						
Blinky Scan						
Continuous Blinky Scan						
Custom (one shot) Scan						
Long-Range In-Stand	*					
Short-Range In-Stand						
Long-Range Out-of-Stand	*					
Short-Range Out-of-Stand						
CodeGate Active In-Stand						
CodeGate Inactive In-Stand	*					
CodeGate Active Out-of-Stand	*					
CodeGate Inactive Out-of-Stand						
UPC/EAN	*					
Code 128	*					
Code 93	*					
Codabar	*					
Interleaved 2 of 5 (ITF)	*					
MOD 10 check on ITF						
Code 11						
Code 39	*					
Full ASCII Code 39						

Appendix B – Default Settings (continued)

PARAMETER	DEFAULT	OCIA	RS-232	LIGHT PEN	IBM 46XX	KBW
Mod 43 Check on Code 39						
MSI-Plessey 10/10 Check Digit						
MSI-Plessey Mod 10 Check Digit	*					
Paraf Support ITF						
ITF Symbol Lengths	Variable					
Minimum Symbol Length	3					
Symbol Length Lock	None					
Bars High as Code 39	*					
Spaces High as Code 39						
Bars High as Scanned						
Spaces High as Scanned						
DTS/SIEMENS						
DTS/NIXDORF	*					
NCR F						
NCR S						
Poll light pen source						
Beeper tone	Normal					
Beep/transmit sequence	Before transmit					
Communication timeout	None					
Razzberry tone on timeout						
Three beeps on timeout						
Same symbol rescan timeout 250 msecs						
Same symbol rescan timeout 375 msecs						
Same symbol rescan timeout: 500 msecs)						
Same symbol rescan timeout 625 msecs						

Appendix B – Default Settings (continued)

PARAMETER	DEFAULT	OCIA	RS-232	LIGHT PEN	IBM 46XX	KBW
Same symbol rescan timeout 750 msec						
Same symbol rescan timeout 875 msec	*					
Same symbol rescan timeout: 1000 msec						
No Same symbol timeout						
Infinite Same symbol timeout						
Inter-character delay Program able in 1 msec steps (max 255 msec)	1 msec 10 msec in KBW					
Number of scan buffers	4					
Transmit UPC-A check digit	*					
Transmit UPC-E check digit						
Expand UPC-E						
Convert UPC-A to EAN-13						
Transmit lead zero on UPC-E						
Transmit UPC-A number system	*					
Transmit UPC-A Manufacturer ID#	*					
Transmit UPC –A Item ID#	*					
Transmit Codabar Start/Stop Characters						
CLSI Editing (Enable)						
Transmit Mod 43 Check digit on Code 39						
Transit Mod 10/ITF						
Transmit MSI-Plessey						
Parity	Space					
Baud Rate	9600					
8 Data Bits						
7 Data Bits	*					
Stop Bits	2					

Appendix B – Default Settings (continued)

PARAMETER	DEFAULT	OCIA	RS-232	LIGHT PEN	IBM 46XX	KBW
Transmit Sanyo ID Characters						
Nixdorf ID						
LRC Enabled						
UPC Prefix						
UPC Suffix						
Carriage Return	*					
Line Feed-Disabled by default in KBW	*					
Tab Prefix						
Tab Suffix						
“DE” Disable Command						
“FL” Laser Enable Command						
DTR Handshaking support						
RTS/CTS Handshaking						
Character Message RTS/CTS	*					
XON/XOFF Handshaking						
ACK/NAK						
Two Digit Supplements				as code 39		
Five Digit Supplements				as code 39		
Bookland				as code 39		
977 (2 digit) Supplemental Requirement						
Supplements are not Required	*					
Two Digit Redundancy	*					
Five digit Redundancy						

Appendix B – Default Settings (continued)

PARAMETER	DEFAULT	OCIA	RS-232	LIGHT PEN	IBM 46XX	KBW
100 msec to Find Supplement Programmable in 100 msec steps (max 800 msec)	*					
Coupon Code 128				as code 39		
Programmable Code Lengths	7 avail					
Programmable Prefix characters	10 avail					
Suffix characters	10 avail					
Prefixes for Individual Code types						
Editing						
Inter Scan-Code delay programmable (100 msec steps)	800 msec					
Function/control Key Support						
Minimum Element width Programmable in 5.6 msec steps	1 msec					

Appendix C

The MS9520 and MS9540 scanner interfaces terminate to a 10-pin modular jack. The serial # label indicates the interface enabled when the scanner is shipped from the factory.

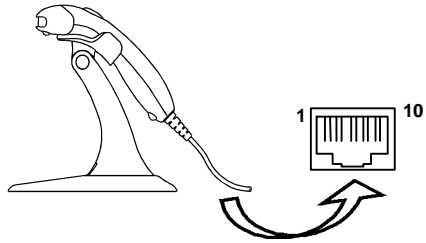

MS9520-9 & MS9520-9 OCIA		MS9520-47 & MS9540-47 Keyboard Wedge and Stand- Alone Keyboard	
Pin	Function	Function	
1	Ground	Ground	
2	RS-232 Transmit Output	RS-232 Transmit Output	
3	RS-232 Receive Input	RS-232 Receive Input	
4	RDATA	PC Data	
5	RDATA Return	PC Clock	
6	Clock in	KB Clock	
7	Clock out	PC +5V	
8	Clock in Return/Clock out Rtrn	KB Data	
9	+5VDC	+5VDC	
10	Shield Ground	Shield Ground	

MS9520-41 & MS9540-41 RS-232C and Light Pen Emulation		MS9520-11 & MS9540-11 IBM 468X/469X	
Pin	Function	Function	
1	Ground	Ground	
2	RS-232 Transmit Output	RS-232 Transmit Output	
3	RS-232 Receive Input	RS-232 Receive Input	
4	RTS Output	RTS Output	
5	CTS Input	CTS Input	
6	DTR Input/LTPN Source	DTR Input	
7	Reserved	IBM B-Transmit	
8	LTPN Data	IBM A+ Receive	
9	+5VDC	+5VDC	
10	Shield Ground	Shield Ground	

Options listed are program/cable selections

Appendix C (continued)

Cable Connector Configurations

“Standard” PowerLink cable	
	
MLPN 53000	
9-pin D-type female connector to the PC	
Pin	Function
1	Shield Ground
2	RS-232 Transmit Output
3	RS-232 Receive Input
4	DTR Input/Light Pen Source
5	Power/Signal Ground
6	Light Pen Data
7	CTS Input
8	RTS Output
9	+5VDC

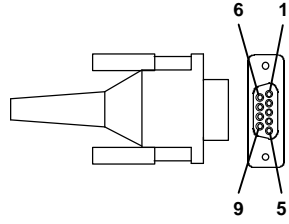

9-Pin D-Type Connector

Appendix C (continued)

Cable Connector Configuration

The PowerLink cable is terminated with a 5-pin DIN female connector on one end, and a 6-pin mini DIN male on the other.

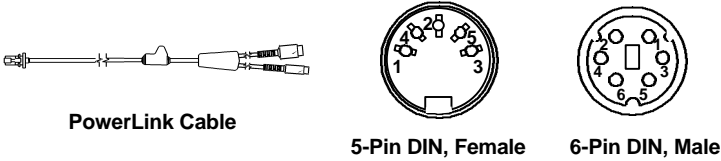

Metrologic will supply an adapter cable with a 5-pin DIN male connector on one end and a 6-pin mini DIN female connector on the other.

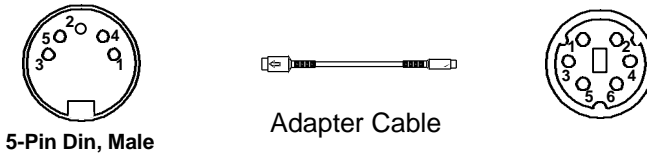

According to the termination required, connect the appropriate end of the adapter cable to the PowerLink cable, leaving the necessary termination exposed for connecting to the keyboard and the keyboard port on the PC. The pin assignments are as follows:

PowerLink Cable

5-pin Female DIN	
Pin	Function
1	Keyboard Clock
2	Keyboard Data
3	No Connect
4	Power Ground
5	+5 Volts DC
6-pin Male Mini-DIN	
Pin	Function
1	Keyboard Data
2	No Connect
3	Power Ground
4	+5 Volts DC
5	PC Clock
6	No Connect

Adapter Cable

5-pin Male DIN	
Pin	Function
1	PC Clock
2	PC Data
3	No Connect
4	Power Ground
5	+5 Volts DC
6-pin Female Mini-DIN	
Pin	Function
1	Keyboard Data
2	No Connect
3	Power Ground
4	+5 Volts DC
5	Keyboard Clock
6	No Connect

Appendix D – Warranty and Disclaimer

Limited Warranty

The MS9500 scanners are manufactured by Metrologic at its Blackwood, New Jersey, USA facility. The MS9500 scanners have a two (2) year limited warranty from the date of manufacture. Metrologic warrants and represents that all MS9500 scanners are free of all defects in material, workmanship and design, and have been produced and labeled in compliance with all applicable US Federal, state and local laws, regulations and ordinances pertaining to their production and labeling.

This warranty is limited to repair, replacement of Product or refund of Product price at the sole discretion of Metrologic. Faulty equipment must be returned to the Metrologic facility in Blackwood, New Jersey, USA or Puchheim, Germany. To do this, contact Metrologic's Customer Service/Repair Department to obtain a Returned Material Authorization (RMA) number.

In the event that it is determined that the equipment failure is covered under the warranty, Metrologic shall, as its sole option, repair the Product or replace the Product with a functionally equivalent unit and return such repaired or replaced Product without charge for service or return freight, whether distributor, dealer/reseller, or retail consumer, or refund an amount equal to the original purchase price.

This limited warranty does not extend to any Product which, in the sole judgement of Metrologic, has been subjected to abuse, misuse, neglect improper installation, or accident, nor any damage due to use or misuse produced from integration of the Product into any mechanical, electrical or computer system. The warranty is void if the case of Product is opened by anyone other than Metrologic's repair department or authorized repair centers.

THIS LIMITED WARRANTY, EXCEPT AS TO TITLE, IS IN LIEU OF ALL OTHER WARRANTIES OR GUARANTEES, EITHER EXPRESS OR IMPLIED, AND SPECIFICALLY EXCLUDES, WITHOUT LIMITATION, WARRANTIES OF MERCHANTABILITY AND FITNESS FOR A PARTICULAR PURPOSE UNDER THE UNIFORM COMMERCIAL CODE, OR ARISING OUT OF CUSTOM OR CONDUCT. THE RIGHTS AND REMEDIES PROVIDED HEREIN ARE EXCLUSIVE AND IN LIEU OF ANY OTHER RIGHTS OR REMEDIES. IN NO EVENT SHALL METROLOGIC BE LIABLE FOR ANY INDIRECT OR CONSEQUENTIAL DAMAGES, INCIDENTAL DAMAGE, DAMAGES TO PERSON OR PROPERTY, OR EFFECT ON BUSINESS OR PROPERTY, OR OTHER DAMAGES OR EXPENSES DUE DIRECTLY OR INDIRECTLY TO THE PRODUCT, EXCEPT AS STATED IN THIS WARRANTY. IN NO EVENT SHALL ANY LIABILITY OF METROLOGIC EXCEED THE ACTUAL AMOUNT PAID TO METROLOGIC FOR THE PRODUCT. METROLOGIC RESERVES THE RIGHT TO MAKE ANY CHANGES TO THE PRODUCT DESCRIBED HEREIN.

Metrologic Instruments, Inc.
90 Coles Road
Blackwood, NJ 08012-4683

Customer Service Department
1-800-ID-METRO (1-800-436-3876)
TEL: 856-228-8100
FAX: 856-228-6673

Metrologic Instruments GmbH
Dornierstrasse 2
82178 Puchheim b.
Munich, Germany
TEL: 49 89 89019 0
FAX: 49 89 89019 200

Appendix E - Notices

Notice

This equipment has been tested and found to comply with the limits for a Class B digital device, pursuant to Part 15 of the FCC rules. These limits are designed to provide reasonable protection against harmful interference in a residential installation. This equipment generates, uses and can radiate radio frequency and, if not installed and used in accordance with the instruction, may cause harmful interference to radio communications. However, there is no guarantee that interference will not occur in a particular installation. If this equipment does cause harmful interference to radio or television reception, which can be determined by turning the equipment off and on, the user is encouraged to try to correct the interference by one or more of the following measures:

- Reorient or relocate the receiving antenna
- Increase the separation between the equipment and receiver
- Connect the equipment into an outlet on a circuit different from that to which the receiver is connected
- Consult the dealer or an experienced radio TV technician for help

Changes or modifications not expressly approved by the party responsible for compliance could void the user's authority to operate the equipment.

Notice

This Class B digital apparatus complies with Canadian ICES-003.

Caution

Use of controls or adjustments or performance of procedures other than those specified herein may result in hazardous laser light. Under no circumstances should the customer attempt to service the laser scanner. Never attempt to look at the laser beam, even if the scanner appears to be nonfunctional. Never open the scanner in an attempt to look into the device. Doing so could result in hazardous laser light exposure. The use of optical instruments with the laser equipment will increase eye hazard.

Remarque

Cet appareil numérique de la class B est conforme à la norme NMB-003 du Canada.

Attention

L'emploi de commandes, réglages ou procédés autres que ceux décrits ici peut entraîner de graves irradiations. Le client ne doit en aucun cas essayer d'entretenir lui-même le scanner ou le laser. Ne regardez jamais directement le rayon laser, même si vous croyez que le scanner est inactif. N'ouvrez jamais le scanner pour regarder dans l'appareil. Ce faisant, vous vous exposez à une rayonnement laser mortel. L'emploi d'appareils optiques avec cet équipement laser augmente le risque d'endommagement de la vision.

Appendix E – Notices (continued)

Achtung

Die Verwendung anderer als der hier beschriebenen Steuerungen, Einstellungen oder Verfahren kann eine lebensgefährliche Laserstrahlung hervorrufen. Der Kunde sollte unter keinen Umständen versuchen, den Laser-Scanner selbst zu warten. Sehen Sie niemals in den Laserstrahl, selbst wenn Sie glauben, daß der Scanner nicht aktiv ist. Öffnen Sie niemals den Scanner, um in das Gerät hineinzusehen. Wenn Sie dies tun, können Sie sich einer lebensgefährlichen Laserstrahlung aussetzen. Der Einsatz optischer Geräte mit dieser Laserausrüstung erhöht das Risiko einer Sehschädigung.

Attenzione

L'utilizzo di sistemi di controllo, di regolazioni o di procedimenti diversi da quelli descritti nel presente Manuale può provocare dei raggi laser pericolosi per la vita. Il cliente non deve assolutamente tentare di riparare egli stesso lo scanner laser. Non guardate mai nel raggio laser, anche se credete che lo scanner non sia attivo. Non aprite mai lo scanner per guardare dentro l'apparecchio. Se tuttavia lo fate, potete esporVi a dei raggi laser pericolosi per la vita. L'uso di apparecchi ottici con questo equipaggiamento laser aumenta il rischio di danni alla vista.

Appendix F

Patents

Patent Information

This METROLOGIC product may be covered by one or more of the following US Patents:

US Patent No. 4,958,984; 5,081,342; 5,260,553; 5,340,971; 5,340,973; 5,424,525; 5,468,951; 5,484,992; 5,525,789; 5,528,024; 5,591,953; 5,616,908; 5,627,359; 5,661,292; 5,777,315; 5,789,730; 5,789,731; 5,811,780; 5,825,012; 5,828,048; 5,883,375; 5,886,337; 5,895,907; 5,925,870; 5,925,871; 5,939,698; D408,532

4,360,798; 4,369,361; 4,387,297; 4,460,120; 4,593,186; 4,607,156; 4,673,805; 4,736,095; 4,758,717; 4,816,660; 4,845,350; 4,896,026; 4,923,281; 4,933,538; 4,992,717; 5,015,833; 5,017,765; 5,059,779; 5,117,098; 5,124,539; 5,130,520; 5,132,525; 5,140,144; 5,149,950; 5,180,904; 5,200,599; 5,229,591; 5,247,162; 5,250,790; 5,250,791; 5,250,791; 5,250,792; 5,262,628; 5,280,162; 5,280,164; 5,304,788; 5,321,246; 5,324,924; 5,396,053; 5,396,055; 5,408,081; 5,410,139; 5,436,440; 5,449,891; 5,468,949; 5,479,000; 5,532,469; 5,545,889

Other worldwide patents pending

No license right or sublicense is granted, either expressly or by implication, estoppel, or otherwise, under any METROLOGIC or third party intellectual property rights (whether or not such third party rights are licensed to METROLOGIC), including any third party patent listed above, except for an implied license only for the normal intended use of the specific equipment, circuits, and devices represented by or contained in the METROLOGIC products that are physically transferred to the user, and only to the extent of METROLOGIC's license rights and subject to any conditions, covenants and restrictions therein.

Addendum

Addendum 1:1

If the optional power adapter available through Metrologic does not power the bar code scanner, the scanner will receive power from a host device such as a computer system. The following statement is applicable:

Caution

To maintain compliance with standards CSA C22.2 No. 950/UL 1950 and norm EN 60950, the power source must meet applicable performance requirements for a limited power source.

Index

A

AC input/outlet 4
Accessories iii, 2
Approvals 18
Audible iii, 10
Autodiscriminates 29

B

Bar Code 1, 3, 10, 11, 12, 14, 15, 16
21, 24, 25, 26, 29, 42
Beep 3, 10, 11, 15, 16, 17, 23, 24
29, 31

C

Cable 2, 27, 29, 36, 37
communication 4, 11, 12,
17, 27, 30
pin assignments 37
PowerLink iii, 1, 2, 3, 4, 5,
17, 36, 37
Caution 2, 18, 39, 42
CDRH 29
Current 10
Customer Service ii, 38

D

Decode Capability 29
Default Settings 3, 4, 15, 16, 22
Depth of field 19, 20
Disclaimer iv, 38

E

Electrical 29

F

Failure indicator(s) 10
Failure modes iii, 10, 13

G

Green LED 3, 10, 11, 23

H

Host iii, 1, 2, 4, 5, 11, 12, 14,
16, 23, 24, 27, 42

I

Indicators
Audible 10
LED 3, 9, 10, 11, 23, 24, 29
Installation 1, 2, 4, 38, 39
Interfaces 23, 29, 35

L

Labels iii, 18

M

Maintenance iii, 21
Meteor 17

N

Notices iv, 39, 40

O

Operation 10
Operational 29
Output window 9

P

Parts iii, 9
PC 4, 17, 22, 26, 29, 35, 36, 37
pin assignments 37
Power supply 3, 4, 5, 17, 23

Q

Quick Start iii, 4

Index

R

Razzberry tone 10, 12, 13, 31
Red LED 3, 10, 11, 17, 24
Repair 13, 38
RMA 38
RS-232 22, 27, 28, 30, 31, 32
33, 34, 35, 36

S

SELV 2
Service ii, 38
Specifications iv, 29

T

Tones 10, 13
Transformers 29
Troubleshooting 23, 24, 25, 26
27

V

Ventilation 29
Voltage 2, 29

W

Warranty iv, 38
Window 9, 21