



# Magellan™ 3200VSi

## Omni-Directional Imaging Scanner



**Quick Reference Guide**

## **Datalogic Scanning, Inc.**

959 Terry Street  
Eugene, Oregon 97402  
USA  
Telephone: (541) 683-5700  
Fax: (541) 345-7140

An Unpublished Work - All rights reserved. No part of the contents of this documentation or the procedures described therein may be reproduced or transmitted in any form or by any means without prior written permission of Datalogic Scanning, Inc. or its subsidiaries or affiliates ("Datalogic" or "Datalogic Scanning"). Owners of Datalogic products are hereby granted a non-exclusive, revocable license to reproduce and transmit this documentation for the purchaser's own internal business purposes. Purchaser shall not remove or alter any proprietary notices, including copyright notices, contained in this documentation and shall ensure that all notices appear on any reproductions of the documentation.

Should future revisions of this manual be published, you can acquire printed versions by contacting your Datalogic representative. Electronic versions may either be downloadable from the Datalogic website ([www.scanning.datalogic.com](http://www.scanning.datalogic.com)) or provided on appropriate media. If you visit our website and would like to make comments or suggestions about this or other Datalogic publications, please let us know via the "Contact Datalogic" page.

### **Disclaimer**

Datalogic has taken reasonable measures to provide information in this manual that is complete and accurate, however, Datalogic reserves the right to change any specification at any time without prior notice. Datalogic and the Datalogic logo are registered trademarks of Datalogic S.p.A. in many countries, including the U.S.A. and the E.U. All other brand and product names may be trademarks of their respective owners.

Magellan is a registered trademark of Datalogic Scanning, Inc. in many countries, including the U.S.A. and the E.U.

This product may be covered by one or more of the following patents: US5179270 • US5837983 • US6705527 • US6729603 • US6758403 • US6877663 • US7108170 • US7234641 • US7299975

# Table of Contents

Quick Reference.....	1
Labeling and Nomenclature .....	1
Installation .....	2
Power Supply .....	3
How to Scan .....	3
Troubleshooting.....	4
Productivity Index Reporting™ Option.....	5
Scanner Push Button .....	5
LED and Beeper Indicators.....	7
Error Codes .....	9
Going Green .....	11
Bar Code Mask.....	12
Programming.....	13
FCC Statement .....	16
Compliance Statement .....	16
Warranty .....	17

# NOTES

# DATALOGIC SCANNING, INC. MAGELLAN™ END USER LICENSE AGREEMENT

**Notice to End User:** The Datalogic Product you have acquired contains embedded Software, which is integral to the product's operation. This Software is being provided to you under license, subject to the terms and conditions of this Agreement. If you use the Datalogic Product, you will be deemed to have accepted the terms and conditions of this Agreement. If you do not intend to be bound to the terms of this Agreement, Datalogic is not willing to license the Software to you, you may not use the Datalogic Product or the Software, and you must contact the party from whom you acquired the Datalogic Product for instructions.

This End User Software License Agreement ("Agreement") is a legally binding agreement governing the licensing of the Software and Documentation by Datalogic, Scanning Holdings, Inc. and its subsidiaries and affiliates ("Datalogic") to the entity or person who has purchased or otherwise acquired a Datalogic Product ("End User"). For purposes of this Agreement, any software that is associated with a separate end-user license agreement is licensed to you under the terms of that license agreement. Datalogic and End User hereby agree as follows:

## **1. Definitions.**

- 1.1 "Documentation" means materials such as user's guides, program reference guides, quick reference guides, manuals, or similar materials associated with or related to the Datalogic Product, whether in printed, "online", or other form.
- 1.2 "Proprietary Information" means: (a) source code, object code, software, documentation, and any related internal design, system design, data base design, algorithms, technology, technical data or information, implementation techniques, and trade secrets related to the Software, (b) any other trade secrets marked appropriately or identified as proprietary or confidential, and (c) any information that End User, under the circumstances, should recognize as confidential. Proprietary Information does not include any information that the receiving party can establish was (1) in the public domain, (2) already in the receiving party's possession or rightfully known prior to receipt, (3) rightfully learned from a third party not in violation of any other's proprietary rights, or (4) independently developed without access to Proprietary Information.
- 1.3 "Datalogic Product" means the Datalogic Magellan™ 1000i series, Magellan™ 1100i series, Magellan™ 1400i series, Magellan™ 2200VS series, Magellan™ 2300HS series, Magellan™ 3200VSi series, Magellan™ 3300HSi series, Magellan™ 8100 series, Magellan™ 8200 series, Magellan™ 8300 series, Magellan™ 8400 series, Magellan™ 8500 series, Magellan™ 9500 series, and/or Magellan SL™ series scanner and/or scanner/scale product, including all embedded Software in and all Documentation related to such product, which has been purchased or otherwise acquired by End User, whether obtained directly or indirectly from Datalogic.
- 1.4 "Software" means any software or computer programs of Datalogic or its third party licensors in machine readable form which is embedded in the Datalogic Product, whether obtained directly or indirectly from Datalogic, including any replacement, update, upgrade, enhancement or modification.

## **2. Scope Of License Granted.**

- 2.1 Datalogic grants to End User a non-exclusive, non-transferable, perpetual license to use the Software, solely on the Datalogic Product in which it is embedded ("designated Datalogic Product"), in machine-readable form only, solely for End User's internal business purposes. This Agreement does not convey ownership of the Software to End User. Title to the Software shall be and remain with Datalogic or the third party from whom Datalogic has obtained a licensed right. As used in this Agreement, the term "purchase" or its equivalents when applied to the Software shall mean "acquire under license." End User is not entitled to receipt or use of the source code to any Software.
- 2.2 End User shall not copy, modify, decompile, disassemble, reverse engineer, or otherwise reproduce or remanufacture the Software, whether modified or unmodified, nor sell, assign, sublicense, distribute, lend, rent, give, or otherwise transfer the Software to any

other person or organization, for purposes other than as expressly provided in this Agreement, without Datalogic's prior written consent.

### **3. Transfers, Support.**

- 3.1 Any copying, installing, reproduction, remanufacture, reverse engineering, electronic transfer, or other use of the Software on other than the designated Datalogic Product will be a material breach of this Agreement. However, Datalogic may elect not to terminate this Agreement or the granted licenses, but instead may elect to notify End User that End User is deemed to have ordered and accepted a license for each breaching use. End User shall pay Datalogic the applicable list price for such licenses as of the date of such breach.
- 3.2 End User shall not sell, assign, sublicense, distribute, lend, rent, give, or otherwise transfer the Datalogic Product to any third party unless such third party agrees with Datalogic in writing to be bound by the terms and conditions of this Agreement. Any such transfer of the Datalogic Product absent such agreement shall be null and void.
- 3.3 End User may obtain support for Software from Datalogic at Datalogic's standard support fees and under Datalogic's standard support terms and conditions in effect at the time the support is requested.

### **4. Intellectual Property.**

End User acknowledges that the Software constitutes valuable trade secrets of Datalogic or Datalogic's third party licensors and that the Software is protected by intellectual property laws and treaties. The license set forth in this Agreement does not transfer to End User any ownership of Datalogic's or its third party licensors' copyrights, patents, trademarks, service marks, trade secrets, or other intellectual property rights and End User shall have no right to commence any legal actions to obtain such rights. End User shall not remove, modify, or take any other action that would obscure any copyright, trademark, patent marking, or other intellectual property notices contained in or on the Datalogic Product.

### **5. Proprietary Information.**

- 5.1 End User acknowledges that Proprietary Information is the confidential, proprietary, and trade secret property of Datalogic and Datalogic's third party licensors and End User acquires no right or interest in any Proprietary Information.
- 5.2 End User shall not disclose, provide, or otherwise make available the Proprietary Information of Datalogic or its third party licensors to any person other than End User's authorized employees or agents who are under confidentiality agreement, and End User shall not use the Proprietary Information other than in conjunction with use of the Datalogic Product exclusively for End User's internal business purposes. End User shall take steps to protect the Proprietary Information no less securely than if it were End User's own intellectual property.
- 5.3 The provisions of this Proprietary Information Section shall survive and continue for five (5) years after the termination of this Agreement.

### **6. Limited Warranty.**

- 6.1 Datalogic warrants that, under normal use and operation, the Datalogic Product will conform substantially to the applicable Documentation for the period specified in the Documentation. During this period, for all reproducible nonconformities for which Datalogic has been given written notice, Datalogic will use commercially reasonable efforts to remedy nonconformities verified by Datalogic. End User agrees to supply Datalogic with all reasonably requested information and assistance necessary to help Datalogic in remediating such nonconformities. For all defects reported to Datalogic within the warranty period, Datalogic's liability is limited to providing End User with one copy of corrections or responding to End User's problem reports according to Datalogic's standard assistance practices. Datalogic does not warrant that the product will meet End User's requirements or that use of the product will be uninterrupted or error free, or that Datalogic's remedial efforts will correct any nonconformance. This limited warranty does not cover any product that has been subjected to damage or abuse, whether intentionally, accidentally, or by neglect, or to unauthorized repair or unauthorized installation, and shall be void if End User modifies the product, uses the product in any manner other than as established in the Documentation, or if End User breaches any of the provisions of this Agreement.
- 6.2 EXCEPT AS PROVIDED IN THIS AGREEMENT, THE DATALOGIC PRODUCT IS PROVIDED "AS IS" AND DATALOGIC MAKES NO WARRANTIES OF ANY KIND, EXPRESS OR IMPLIED, WRITTEN OR ORAL, WITH RESPECT TO THE PRODUCT, AND SPE-

CIFICALLY DISCLAIMS THE IMPLIED WARRANTIES OF MERCHANTABILITY AND FITNESS FOR A PARTICULAR PURPOSE.

## **7. Infringement.**

- 7.1 Datalogic will defend End User against any claim in a lawsuit that the Datalogic Product furnished hereunder infringe a United States patent or copyright of a third party and Datalogic will pay any damages finally awarded against End User by a court of competent jurisdiction that are attributable to such claim or will pay End User's part of any settlement that is attributable to such claim, provided, that 1) End User notifies Datalogic promptly in writing of the claim, 2) Datalogic controls the defense or settlement of the claim, and 3) End User cooperates fully with Datalogic in such defense or settlement. All notices of a claim should be sent to Datalogic Scanning Holdings, Inc., Legal Department, 959 Terry Street, Eugene, OR 97402.
- 7.2 In the defense or settlement of any such claim, Datalogic may, at its option, 1) procure for End User the right to continue using the Datalogic Product, 2) modify the Datalogic Product so that it becomes non-infringing, 3) replace the Datalogic Product with an equivalent product not subject to such claim, or 4) provide End User an opportunity to return the Datalogic Product and receive a refund of the purchase price paid, less a reasonable allowance for use.
- 7.3 Datalogic shall have no liability to End User for claims of infringement based upon 1) the use of any Datalogic Product in combination with any product which Datalogic has not either furnished or authorized for use with such Datalogic Product 2) the use of any Datalogic Product designed, manufactured, or modified to the specifications of End User, or 3) End User's modification of the Datalogic Product without written authorization from Datalogic.
- 7.4 THE FOREGOING STATES DATALOGIC'S COMPLETE AND ENTIRE OBLIGATION CONCERNING CLAIMS OF PATENT, COPYRIGHT, OR OTHER INTELLECTUAL PROPERTY INFRINGEMENT, CANCELS AND SUPERSEDES ANY PRIOR AGREEMENTS, WHETHER ORAL OR WRITTEN, BETWEEN THE PARTIES CONCERNING SUCH CLAIMS, AND WILL NOT BE MODIFIED OR AMENDED BY ANY PAST, CONTEMPORANEOUS, OR FUTURE AGREEMENTS OR DEALINGS BETWEEN THE PARTIES, WHETHER ORAL OR WRITTEN, EXCEPT AS SET FORTH IN A FUTURE WRITING SIGNED BY BOTH PARTIES.

## **8. Limitation Of Liability.**

EXCEPT AS PROVIDED IN SECTION 7, DATALOGIC SHALL NOT BE LIABLE FOR ANY CLAIMS AGAINST END USER BY ANY OTHER PARTY. IN NO EVENT SHALL DATALOGIC'S LIABILITY FOR DAMAGES, IF ANY, WHETHER BASED UPON CONTRACT, TORT (INCLUDING NEGLIGENCE), PRODUCT LIABILITY, STRICT LIABILITY, WARRANTY, OR ANY OTHER BASIS, EXCEED THE PRICE OR FEE PAID BY END USER FOR THE DATALOGIC PRODUCT. UNDER NO CIRCUMSTANCES SHALL DATALOGIC BE LIABLE TO END USER OR ANY THIRD PARTY FOR LOST PROFITS, LOST DATA, INTERRUPTION OF BUSINESS OR SERVICE, OR FOR ANY OTHER SPECIAL, CONSEQUENTIAL, CONTINGENT, INDIRECT, INCIDENTAL, PUNITIVE, EXEMPLARY, OR OTHER SIMILAR DAMAGES, EVEN IF DATALOGIC HAS BEEN ADVISED OF THE POSSIBILITY OF SUCH DAMAGES.

## **9. Government Restricted Rights; International Use.**

- 9.1 Use, duplication, or disclosure of the Software by the U.S. Government is subject to the restrictions for computer software developed at private expense as set forth in the U.S. Federal Acquisition Regulations at FAR 52.227-14(g), or 52.227-19 or in the Rights in Technical Data and Computer Software clause at DFARS 252.227-7013(c)(1)(ii), whichever is applicable.
- 9.2 If End User is using the Datalogic Product outside of the United States, End User must comply with the applicable local laws of the country in which the Datalogic Product is used, with U.S. export control laws, and with the English language version of this Agreement. The provisions of the "United Nations Convention on International Sale of Goods" shall not apply to this Agreement.

## **10. Termination.**

- 10.1 Either party may terminate this Agreement or any license granted under this Agreement at any time upon written notice if the other party breaches any provision of this Agreement.
- 10.2 Upon termination of this Agreement, End User immediately shall cease using any non-

embedded software and shall return to Datalogic or destroy all non-embedded software covered by this Agreement, and shall furnish Datalogic with a certificate of compliance with this provision signed by an officer or authorized representative of End User. For embedded software, End User agrees to sign a waiver prepared by Datalogic concerning further use of the embedded Software. End User's resumed or continued use of the embedded Software after termination shall constitute End User's agreement to be bound by the terms and conditions of this Agreement for such use.

## **11. General Provisions.**

- 11.1 Entire Agreement; Amendment. This document contains the entire agreement between the parties relating to the licensing of the Software and supersedes all prior or contemporaneous agreements, written or oral, between the parties concerning the licensing of the Software. This Agreement may not be changed, amended, or modified except by written document signed by Datalogic.
- 11.2 Notice. All notices required or authorized under this Agreement shall be given in writing, and shall be effective when received, with evidence of receipt. Notices to Datalogic shall be sent to the attention of Contract Administration, Datalogic Scanning Holdings, Inc., 959 Terry Street, Eugene, OR 97402, or such other address as may be specified by Datalogic in writing.
- 11.3 Waiver. A party's failure to enforce any of the terms and conditions of this Agreement shall not prevent the party's later enforcement of such terms and conditions.
- 11.4 Governing Law; Venue: This Agreement and the rights of the parties hereunder shall be governed by and construed in accordance with the laws of the State of Oregon U.S.A, without regard to the rules governing conflicts of law. The state or federal courts of the State of Oregon located in either Multnomah or Lane counties shall have exclusive jurisdiction over all matters regarding this Agreement, except that Datalogic shall have the right, at its absolute discretion, to initiate proceedings in the courts of any other state, country, or territory in which End User resides, or in which any of End User's assets are located.
- 11.5 Attorneys' Fees. In the event an action is brought to enforce the terms and conditions of this Agreement, the prevailing party shall be entitled to reasonable attorneys' fees, both at trial and on appeal.

**- END -**



# Quick Reference

Use this guide to quickly complete your installation and begin using your scanner. For more details, including programming information, reference the Product Reference Guide (PRG), which is available for viewing and download from the Datalogic website listed on the back cover of this manual.

## Labeling and Nomenclature

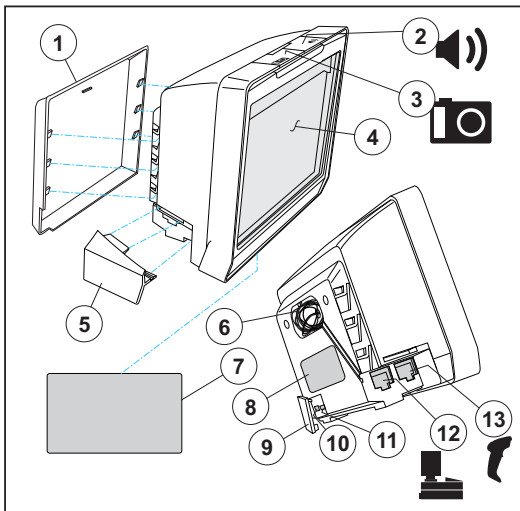

- |                                   |  |
|-----------------------------------|--|
| 1. Back Cover                     | 8. P/N Label   |
| 2. Scanner Push Button            | 9. USB/SD Cover  |
| 3. Camera Push Button             | 10. USB Test Port                                      |
| 4. Scan Window                    | 11. SD Card Slot                                       |
| 5. Cable Connector Cover          | 12. Host (blue) Port                                   |
| 6. Checkpoint EAS Wire Cavity     | 13. Auxiliary (yellow) Port for handheld scanner, etc. |
| 7. Serial Number/Regulatory Label |  |

# Installation

Connect the scanner to the host (terminal) using the interface (I/F) cable as shown below. A cable from an older existing installation can be re-used if it uses Power Off the Terminal (POT), unless it is a USB POT cable. If external power is used/needed, plug the AC Adapter into the AC wall outlet, then connect it to the I/F cable as shown in 'b' and 'c' of the illustration.

Scan some known-good bar code samples to verify correct operation. The scanner should beep and/or flash its good read LED<sup>1</sup> and send the bar code data to the host or terminal. If not, use the Troubleshooting section of this guide to identify any problems.

Scanner installation is complete.

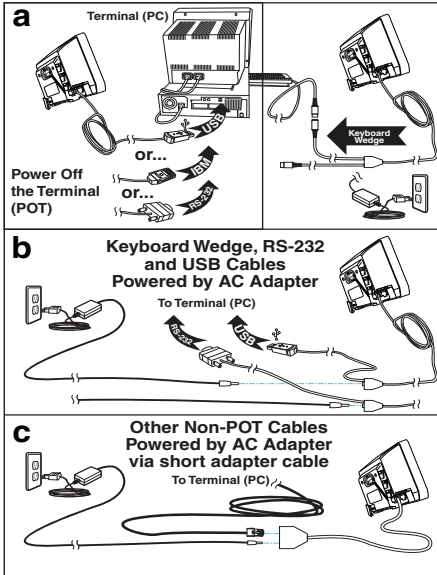

1. Be aware that beeper and LED behavior may have previously been configured as "disabled" by another user.

# Power Supply

Models require<sup>1</sup> either a Listed class II or class III with a Limited Power Source (LPS). For the safety certification to be valid, class III input power sources must be IEC/EN60950-1 (EN 60335-series, EN 60065 or relevant) approved.

Input: 100 - 240 VAC

Output: 12 VDC

Max. Current: 1.5 A

Max. Power: 18 W

# How to Scan

Bar codes can either be presented to the scanner's window or pushed past it using a "sweep" technique. The scanner can alternatively be programmed to initiate a scan of a cell phone or other LCD bar code object, or an image capture upon pushing the Camera Push Button. See the PRG for more details.



1. Product
2. Scan Window
3. Bar code

4. Sweeping motion
5. Presentation motion

---

1. Power Off the Terminal (POT) units do not require a power supply.

# Troubleshooting

Use this table to resolve common problems.

PROBLEM	SOLUTION
Scanner does not power-on	Exchange the power supply with a known good power supply and retest operation.
No communication with the host	Consult your technical support personnel or refer to your host system manual to verify the proper interface type, cable and connection port(s) for the scanner. Verify the interface cable is securely attached to the host and the scanner.
The scanner will not read bar codes at all, or reads poorly	Make sure the window is clean. Check that the barcodes are of sufficient quality to be recognized by the scanner. Wrinkled, smudged, or torn labels can cause the scanner to not read at all. Scan known-good labels of an active symbology <sup>a</sup> to check the scanner's read operation.
If the scanner still does not function properly, consult the Product Reference Guide (PRG) or contact your local supplier or Datalogic Customer Support Services.	

- a. Reading of the various barcode symbologies can be independently enabled or disabled in the scanner.

# Productivity Index Reporting™ Option

Your scanner may be equipped with the optional Productivity Index Reporting™ feature. This feature allows for data collection on the readability index of bar codes scanned by the scanner. This data may be transmitted to the POS Terminal where it may be easily sorted for action by the MIS department to improve bar code quality at the front end. For additional information on how to enable Productivity Index Reporting in your scanner, please refer to the Product Reference Guide (PRG)

## Scanner Push Button

The Scanner Push Button also performs multiple functions depending upon the duration of time it is pressed:



### NOTE

Volume changes made using the Volume/Tone Push Button are lost when the scanner is powered-down and are reset to the configured setting. If you wish to permanently change the volume, use the special programming labels in the Product Reference Guide.

**Table 1. Scanner Push Button Functions**

PRESS DURATION	FUNCTION	COMMENT
Momentary (when scanner is asleep)	Wakes scanner from Sleep Mode	Alternatively, the scanner can be awakened by: - Moving an object through the scan zone. - Scanning with an attached auxiliary scanner.

**Table 1. Scanner Push Button Functions**

<b>PRESS DURATION</b>	<b>FUNCTION</b>	<b>COMMENT</b>
Momentary (when scanner is awake)	Increments volume	Press the push button momentarily to increase speaker volume. When the loudest volume is reached, a repeated press of the push button cycles volume back to the lowest setting, then volume increases on subsequent press(es). Four volume levels are available.
Hold, then release when the beeper sounds	Increments tone	Press the push button for approximately 2 seconds, then release. Each time this is done, the beeper will sound at one of three tones. Stop when the desired tone (high, medium or low) is sounded.
4 Seconds	Scanner Diagnostics Mode <sup>a</sup>	This mode allows system support personnel to troubleshoot problems with the scanner and is used to determine if it can read bar codes. Press the button for eight seconds or cycle power to exit Scanner Diagnostics Mode and reset the scanner.
8 Seconds	Resets Scanner <sup>b</sup>	Only system support personnel should perform a reset.

- a. By standard default, this function is normally disabled to prevent accidental activation by users.
- b. Users should not perform scanner resets except under the direction of trained systems support personnel.

# LED and Beeper Indicators

The scanner's beeper sounds and its green LED illuminates to indicate various functions or errors on the scanner. The tables below list these indications. An exception to the behaviors listed in the tables is that the scanner's functions are programmable, and may or may not be turned on. For example, certain indications, such as the power-up beep can be disabled using programming barcode labels.

**Table 2. Green LED Indications**

LED INDICATION	INDICATION	COMMENT
Power-on indication	Bright green flash	Indicates the scanner has finished all its power up tests and is now ready for operation.
Good Read Indication	Bright green flash	Indicates a barcode has been read and decoded.
Scanner Ready	Constant dim green	The scanner is ready for operation.
Sleep Mode	Green LED slowly and continuously changes from off to dim to off.	The scanner is in Sleep Mode. To wake the scanner up, move an object in front of its window or press the button atop the unit. This indication is optionally configurable, and may have been programmed to behave differently.
Host Disable	Constant green flash at 1 Hz (100mS on, 900mS off)	The scanner is disabled due to receiving a disable command from the POS terminal.

**Table 2. Green LED Indications**

LED INDICATION	INDICATION	COMMENT
Diagnostics	Varies (see <a href="#">Error Codes on page 9</a> for more information)	The LED can provide diagnostic feedback if the scanner discovers a problem during SelfTest.
Prog. Mode	See Host Disable above.	The scanner is in Programming Mode.

**Table 3. Beeper Functions**

BEEPER INDICATION	INDICATION	COMMENT
Power On Beep	Single beep	The Power-On LED indication is a configurable feature which can be enabled or disabled. When enabled, this beep indicates the scanner has finished all its power up tests and is now ready for operation.
Good Read Indication	Single beep	The good read beep indication is configurable. Options include: Enable/disable, frequency, duration and volume. See the Product Reference Guide (PRG) for more information.
Diagnostics	Varies (see <a href="#">Error Codes on page 9</a> for more information)	The Beeper can provide diagnostic feedback if the scanner discovers a problem during SelfTest.
Programming Mode Indications	Varies depending upon the feature(s) being configured.	The Beeper will sound as programming barcode labels are scanned, indicating progress during scanner configuration.



# Error Codes

If an error is detected, the scanner will sound a long low tone (for three seconds) and flash its LED, indicating a failure. When this occurs, press the Scanner Push button to hear the error code. If it is configured to do so, the scanner will sound a series of beeps corresponding to the error code and/or flash its LED simultaneous to the beeps. The table below describes what these codes mean and what action should be taken for each.

<b>NUMBER OF LED FLASHES/ BEEPS</b>	<b>ERROR</b>	<b>CORRECTIVE ACTION</b>
1	Configuration	Contact Helpdesk for assistance
2	Interface PCB	
4	Imager	
6	Main PCB	
10	Button Error	
11	Hardware ID	
12	Model ID	
13	CPLD ID	

# NOTES

## Going Green

Thank you for using the bar code mask on the opposite side of this page. This manual has been formatted to minimize the quantity of pages needed to provide all of the programming bar codes available for this product.



# Bar Code Mask

Cut a hole in this page and remove it from the manual as indicated to create a sleeve through which bar codes (starting on the following page) can be individually viewed and scanned. It is important that only one bar code at a time be presented to the scanner.

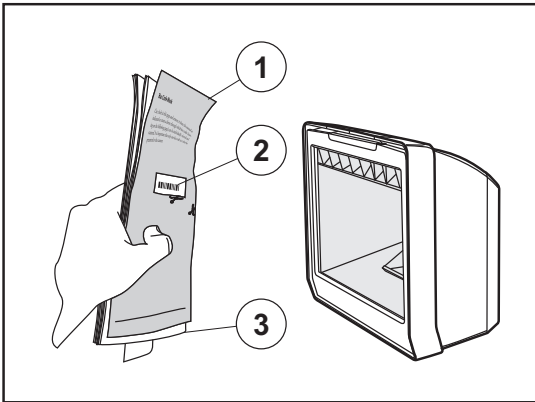
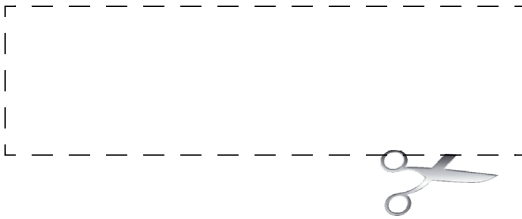



- 1. Bar Code Mask Sheet
- 2. Bar Code
- 3. Manual (folded)

# Programming

Upon completing the physical connection between the reader and its host, proceed directly to the Programming Bar Codes table below to locate the interface type the reader is connected to (for example: RS-232, Keyboard Wedge, USB, etc.).

Use the Bar Code Mask on the preceding page to isolate the bar code you intend to scan. Scan a Start/End bar code once to enter Programming Mode. After selecting (scanning) the interface, scan the ENTER/EXIT barcode a second time, which will then accept your changes, exit Programming Mode and return the reader to normal operation.

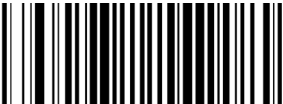
You can select other options and customize your reader through use of the instructions and programming barcodes available in the PRG or use the On Screen Programming (OSP) utility available from the website listed on the back cover of this manual.

 START / END
<b>PROGRAMMING BAR CODES</b>
 RS-232 Standard
 RS-232 Wincor-Nixdorf



START / END



IBM 4683 Port 5B

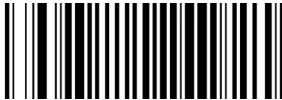

IBM 4683 Port 9B



IBM 4683 Port 17



USB-OEM



START / END



USB Keyboard



USB COM Interface



Keyboard Wedge A (PC/XT w/alternate Key Encoding)



**NOTE**

If other than Keyboard Wedge A with USA keyboard is needed, see the PRG or On Screen Programming for additional options.

# FCC Statement

This Equipment has been tested and found to comply with the limits for a Class B digital device, pursuant to part 15 of the FCC Rules. These limits are designed to provide reasonable protection against harmful interference in a residential installation. This equipment generates uses and can radiate radio frequency energy and, if not installed and used in accordance with these instructions, may cause harmful interference to radio communications. However, there is no guarantee that interference will not occur in a particular installation. If this equipment does cause harmful interference to radio or television reception, which can be determined by turning the equipment off and on, the user is encouraged to try to correct the interference by one or more of the following measures:

- Reorient or relocate the receiving antenna
- Increase the separation between the equipment and receiver
- Connect the equipment into an outlet on a circuit different from that to which receiver is connected
- Consult the dealer or an experienced radio / TV technician for help.



**CAUTION**

**The User is cautioned that changes or modifications not expressly approved by the part responsible for compliance could void the user's authority to operate the equipment.**

# Compliance Statement

**This Class B digital apparatus complies with Canadian ICES -003.  
Cet appareil numérique de la classe B est conforme à la norme NMB-003 du Canada.**

## LED Class

CLASS 1 LED PRODUCT	APPARECCHIO LED CLASSE 1
LED KLASSE 1	APPAREIL A LED DE CLASSE 1

IEC / EN 60825-1:2007

Max output of LED radiation: 3.21mW per pulse at 100mm

Pulse duration: 200us

Emitted wavelength 625nm



# Warranty

Datalogic warrants to Customer that this product will be free from defects in materials and workmanship for a period of 3 years from product shipment. In order to obtain service under this Warranty, Customer must notify Datalogic of the claimed defect before the expiration of the Warranty period and obtain from Datalogic a return authorization number for return of the product to designated Datalogic service center. If Datalogic determines Customer's claim is valid, Datalogic will repair or replace product without additional charge for parts and labor. Customer shall be responsible for packaging and shipping the product to the designated Datalogic service center, with shipping charges prepaid. Datalogic shall pay for the return of the product to Customer if the shipment is to a location within the country in which the Datalogic service center is located. Customer shall be responsible for paying all shipping charges, duties, taxes, and any other charges for products returned to any other locations.

Warranty is subject to the limitations and exclusions set forth in the paragraphs that follow.

WARRANTY SET FORTH ABOVE IS IN LIEU OF ANY OTHER WARRANTIES, EXPRESS OR IMPLIED, INCLUDING MERCHANTABILITY AND FITNESS.

## Exclusions

Warranty coverage shall not apply to any claimed defect, failure or damage which Datalogic determines was caused by: abuse, neglect, improper use of product; failure to provide product maintenance, including but not limited to cleaning of the scan window in accordance with product reference guide; installation or service of product by other than Datalogic representatives; use of product with any other instrument, equipment or apparatus; modification or alteration of product or units with Warranty Void labels that have been tampered with. External cables and replacement of upper window/cartridge due to scratching, stains or other degradation will not be covered under the Warranty. External power supplies returned for service must be accompanied by the original product for performance of service.

Returned products that Datalogic Inc. has determined are not covered by Warranty, will be charged Datalogic Inc. standard repair rates then in effect for repair of product. Replacement of scan window due to scratching, stains or other degradation will not be cov-

ered under Warranty. If a product is determined to be not repairable customer will be notified and product may be returned to customer at their request. A minimum repair fee may be charged.

## Limitation of Liability

DATALOGIC's REPAIR OR REPLACEMENT OF DEFECTIVE PRODUCT AS SET FORTH ABOVE IS THE CUSTOMER'S SOLE AND EXCLUSIVE REMEDY ON ACCOUNT OF CLAIMS OF BREACH OF WARRANTY OR PRODUCT DEFECT. UNDER NO CIRCUMSTANCES WILL DATALOGIC BE LIABLE TO CUSTOMER OR ANY THIRD PARTY FOR ANY LOST PROFITS, OR ANY INCIDENTAL, CONSEQUENTIAL INDIRECT, SPECIAL OR CONTINGENT DAMAGES REGARDLESS OF WHETHER DATALOGIC HAD ADVANCE NOTICE OF THE POSSIBILITY OF SUCH DAMAGES.

## Assignment

Customer may not assign or otherwise transfer its rights or obligations under Warranty except to a purchaser or transferee of product. No attempted assignment or transfer in violation of this provision shall be valid or binding upon Datalogic.

## Risk of Loss

Customer shall bear risk of loss or damage for product in transit to Datalogic. Datalogic shall assume risk of loss or damage for product in Datalogic's possession or product being returned to Customer by Datalogic, except such loss or damage as may be caused by the negligence of Customer, its agents or employees. In the absence of specific written instructions for the return of product to Customer, Datalogic will select the carrier, but Datalogic shall not thereby assume any liability in connection with the return shipment.

# EUROPEAN DECLARATION OF CONFORMITY



Datalogic Scanning, Inc. hereby declares that the apparatus specified below has been tested and found compliant to the following European Council Directives and Harmonized Standards.

Equipment Type: Barcode Scanning Equipment

Apparatus: Magellan™ 3200VSi and Magellan™ 3300HSi

Manufactured by: Datalogic Scanning, Inc.  
959 Terry St. Eugene, OR USA Ph: 541-683-5700

Datalogic Scanning Slovakia s.r.o.  
Priloy 47  
919 26 Zavar, Slovakia, Ph: 421 33 590 8970

Datalogic Scanning Vietnam LLC.  
Lot 1-4b Saigon High Tech Park,  
Dist. 9 Ho Chi Minh City, Ph: 84 837 30 8481

Placed into EU Service: June 16, 2010

Council Directives: EMC 2004/108/EC  
Low Voltage 2006/95/EC  
RoHS 2002/95/EC  
WEEE 2002/96/EC

Standards:	EN 55022: 2006,A1:2007	Generic Emission
	AZ/NZS CISPR22:2009	Generic Emission
	EN 55024:1998,A1:2001,A2:2003	Generic Immunity - ITE
	EN 61000-3-2:2006	Harmonic Current
	EN 6100-3-3:1995,A1:2001,A2:2005	Voltage Fluctuation/Flicker
	EN 60950-1:2001,A11:2009	Safety of Information Tecnology Equip.
	EN 60825-1:2007	Safety of Laser/LED Products

A technical construction file for this apparatus is retained at the above address.

A handwritten signature in black ink that reads "Brad West".

---

May 28, 2010  
Brad West  
Vice President  
Supply Chain Operations  
Datalogic Scanning, Inc.



**Australia**

Datalogic Scanning Pty Ltd  
Telephone: [61] (2) 9870 3200  
australia.scanning@datalogic.com

**France and Benelux**

Datalogic Scanning SAS  
Telephone: [33].01.64.86.71.00  
france.scanning@datalogic.com

**Germany**

Datalogic Scanning GmbH  
Telephone: 49 (0) 61 51/93 58-0  
germany.scanning@datalogic.com

**India**

Datalogic Scanning India  
Telephone: 91- 22 - 64504739  
india.scanning@datalogic.com

**Italy**

Datalogic Scanning SpA  
Telephone: [39] (0) 39/62903.1  
italy.scanning@datalogic.com

**Japan**

Datalogic Scanning KK  
Telephone: 81 (0)3 3491 6761  
japan.scanning@datalogic.com

**Latin America**

Datalogic Scanning, Inc  
Telephone: (305) 591-3222  
latinamerica.scanning@datalogic.com

**Singapore**

Datalogic Scanning Singapore PTE LTD  
Telephone: (65) 6435-1311  
singapore.scanning@datalogic.com

**Iberia**

Datalogic Scanning SAS Sucursal en España  
Telephone: 34 91 746 28 60  
spain.scanning@datalogic.com

**United Kingdom**

Datalogic Scanning LTD  
Telephone: 44 (0) 1582 464900  
uk.scanning@datalogic.com



[www.scanning.datalogic.com](http://www.scanning.datalogic.com)

**Datalogic Scanning, Inc.**

959 Terry Street  
Eugene, OR 97402  
USA  
Telephone: (541) 683-5700  
Fax: (541) 345-7140

